



"City of Choice"

City Council Meeting

Tuesday, April 14, 2026, 6:30 PM
Council Chambers
200 S. Main St.
Cibolo, Texas 78108

Est. Duration: 1 hr 55 min

1. Call to Order

2. Roll Call and Excused Absences

2.A. Excused Absence

3. Invocation

4. Pledge of Allegiance

5. Proclamations

5.A. National Sexual Assault Awareness and Prevention Month (Mr. Rossett)

5.B. National Crime Victims' Rights Week (Ms. Story)

5.C. Child Abuse Prevention & Awareness Month (Ms. Meehan/Ms. Williams)

6. Citizens to be Heard

This is the only time during the Council Meeting that a citizen can address the City Council. It is the opportunity for visitors and guests to address the City Council on any issue to include agenda items. All visitors wishing to speak must fill out the Sign-In Roster prior to the start of the meeting. City Council may not deliberate any non-agenda issue, nor may any action be taken on any non-agenda issue at this time; however, City Council may present any factual response to items brought up by citizens. (Attorney General Opinion - JC-0169) (Limit of three minutes each.) All remarks shall be addressed to the Council as a body. Remarks may also be addressed to any individual member of the Council so long as the remarks are (i) about matters of local public concern and (ii) not disruptive to the meeting or threatening to the member or any attendee including City staff. Any person violating this policy may be requested to leave the meeting, but no person may be requested to leave or forced to leave the meeting because of the viewpoint expressed. Citizens who want to submit written comments to be read during the citizen comments portion of a city council meeting should include their name, address and reason why they are unable to attend the meeting at which they want their comments read. Comments must be submitted to the City Secretary at citysecretary@cibolotx.gov no later than 2:00PM prior to the City Council meeting. All comments received that include the required information will be provided to the Mayor and Council and may be summarized or read at the meeting at the discretion of the presiding officer. This meeting is livestreamed.

7. Strategic Partnership Presentations

- 7.A. Presentation from Schertz Cibolo Universal City (SCUC) Independent School District (ISD) about the 2026 Bond for SCUC ISD. (Paige Meloni, SCUC ISD Superintendent)

8. Consent Agenda - Consent Items (General Items)

(All items listed below are considered to be routine and non-controversial by the council and will be approved by one motion. There will be no separate discussion of these items unless a Council member so requests, in which case the item will be removed from the consent agenda and will be considered as part of the order of business.)

- 8.A. Approval of the minutes from the March 7, 2026, Council Workshop
- 8.B. Approval of the minutes from the March 24, 2026, joint workshop.
- 8.C. Approval of the minutes from the March 28, 2026, Strategic Management Workshop.
- 8.D. Approval of the minutes from the March 24, 2026, regular Council meeting.

9. Mayor's Follow-Up

- 9.A. Union Pacific sidewalk across railroad track on Main St.

10. Staff Update

- 10.A. CM Admin Update
- a. 130 Haeckerville Road Clean-up on April 18
 - b. Scheduling Tours - CCMA, GBRA, and CRWA
 - c. Capital Improvement Program – Updates on Projects Main Street sidewalk across railroad – Planning SB 1555 Grant - Planning Veterans/Niemietz Park Renovations – Planning Community Center Renovations Phase II - Planning FM 78 – Water Main Extension – Under Construction FM 78 – Sewer Rehabilitation – Under Construction FM 1103 – Utility Relocation – Design Deer Creek Blvd (Cordero to Falling Sun) – Substantial Completion FY25 Street Rehabilitation Package 2 – Under Construction Silver Wing (CVD to Thistle Creek) Town Creek Road (Green Valley Rd to Bentwood Pass) Firebird Run (Silver Wing to Kipper Ave) Tolle Rd - Design Town Creek Trail - Design
 - d. RFP's, RFQ's, RFB's, and ITB's
 - e. Staff Travel
- 10.B. Police Department

11. Discussion/Action

- 11.A. Discussion/Action on approval of the Niemietz Park and Veterans Memorial Park Master Plans and authorization for the City Manager to proceed with construction plan development. (Ms. Hernandez/Kimley-Horn).
- 11.B. Discussion/Action on approving funding for Old Town/Downtown lighting improvements (LED lantern toppers) as recommended by the Cibolo Economic Development Corporation (CEDC) (Mr. Hardin)

- 11.C. Discussion/Action on evaluation process for Council appointed positions (City Manager, City Secretary, City Attorney, Municipal Court Judge). (Mayor Latimer)
- 11.D. Discussion/Action for City Council to approve the FY26 Capital Improvement Program (Mr. Gomez)
- 11.E. Discussion/Action to approve an Additional Service Request with EIKON Consulting Group, LLC for professional design services for the Public Safety Facility Project in an amount not to exceed \$150,045 and authorize the City Manager to execute the associated change order for \$150,045. (Mr. Huggins)
- 11.F. Discussion/Action on updating the FLUM along portions of the FM 78 and IH 10 corridors to reflect neighborhood commercial, regional activity center, or light industrial/business park place types. (Mayor Latimer)
- 11.G. Discussion from Councilmembers that have attended seminars, events, or meetings. (Council)
- 11.H. Discussion on items the City Council would like to see on future agendas. (Council)
- 11.I. Discussion/Action on the review and confirmation of all upcoming special meetings and workshops and scheduling the time, date and place of additional special meetings or workshops. (Ms. Chapman)

12. Executive Session

The City Council will meet in Executive Session as authorized by the Texas Gov't Code Section 551.074, Personnel Matters, to discuss the following:

- 12.A. Discussion regarding the duties and responsibilities of the City Manager.

13. Open Session

Reconvene into Regular Session and take/or give direction or action, if necessary, on items discussed in the Executive Session.

14. Adjournment

This Notice of Meeting is posted pursuant to the Texas Government Code 551.041 - .043 on the front bulletin board of the Cibolo Municipal Building, 200 South Main Street, Cibolo, Texas which is a place readily accessible to the public at all times and that said notice was posted on

Valerie A. Chapman, TRMC

City Secretary

Pursuant to Section 551.071, 551.072, 551.073, 551.074, 551.076, 551.077, 551.084 and 551.087 of the Texas Government Code, the City of Cibolo reserves the right to consult in closed session with the City Attorney regarding any item listed on this agenda. This agenda has been approved by the city's legal counsel and subject in any Executive Session portion of the agenda constitutes a written interpretation of Texas Government Code Chapter 551. This has been added to the agenda with the intent to meet all elements necessary to satisfy Texas Government Code Chapter 551.144.

A possible quorum of Council, committees, commissions, boards and corporations may attend this meeting.

This facility is wheelchair accessible and accessible parking space is available. Request for accommodation or interpretive services must be made 48 hours prior to the meeting. Please contact the City Secretary at (210) 566-6111. All cell phones must be turned off before entering the Council Meeting.

I certify that the attached notice and agenda of items to be considered by the City Council was removed by me from the City Hall bulletin board on the ____ day of _____ 2026.

Name and Title

Date Posted: April 8, 2026 05:52 pm



City Council Regular Meeting Staff Report

A. National Sexual Assault Awareness and Prevention Month (Mr. Rossett)

Meeting	Agenda Group
Tuesday, April 14, 2026, 6:30 PM	Proclamations Item: 5A.
From	
Valerie Chapman, City Secretary	

PRIOR CITY COUNCIL ACTION:

N/A

BACKGROUND:

N/A

STAFF RECOMMENDATION:

N/A

FINANCIAL IMPACT:

N/A

MOTION(S):

N/A

Attachments

[National Sexual Assault Awareness and Prevention Month April 2026.pdf](#)



Proclamation

National Sexual Assault Awareness and Prevention Month

- Whereas** every 68 seconds another person in the United States is sexually assaulted, and in Texas 2 in 5 women and 1 in 5 men are victims of sexual assault; AND in fiscal year 2025, Thriving Hearts Crisis Center rendered 552 services to 93 survivors of sexual violence and provided 94 hospital accompaniments for sexual assault exams.
- Whereas** according to a study conducted by the Texas Association Against Sexual Assault and The University of Texas at Austin Institute on Domestic Violence and Sexual Assault approximately 6.3 million Texans have been sexually victimized.
- Whereas** most victims are sexually assaulted by someone they know, and 91 percent of victims did not report to police.
- Whereas** it is appropriate to salute the more than 20 million victims who have survived sexual assault in the United States and the efforts of victims, volunteers, and professionals who combat sexual assault.
- Whereas** national and community organizations and private sector supporters should be recognized and applauded for their work in promoting awareness about sexual assault.
- Whereas** police, forensic workers, and prosecutors should be recognized and commended for their hard work and innovative strategies to increase the percentage of sexual assault cases that resolve in the prosecution and incarceration of the offenders.
- Whereas** sexual violence is a persistent and pervasive problem in our society, one that requires attention year-round and in order to foster healthy communities, all citizens must support the effort to end sexual violence every month of the year; and,
- Whereas** national and community organizations, businesses in the private sector, and the media are urged, through *National Sexual Assault Awareness* of sexual violence and strategies to decrease the incidence of sexual assault.

Now therefore, Be It Resolved, I Kara Latimer, Mayor of the City of Cibolo do hereby proclaim the month of April as “*National Sexual Assault Awareness and Prevention Month*” in Cibolo and urge all citizens to observe this month by supporting the goals and ideas of victims and those working toward awareness and prevention, and by participating in community efforts.

In Witness Whereof, I have here unto set my hand this 14th day of **April 2026**

Kara Latimer, Mayor
City of Cibolo



City Council Regular Meeting Staff Report

B. National Crime Victims' Rights Week (Ms. Story)

Meeting	Agenda Group
Tuesday, April 14, 2026, 6:30 PM	Proclamations Item: 5B.
From	
Valerie Chapman, City Secretary	

PRIOR CITY COUNCIL ACTION:

N/A

BACKGROUND:

N/A

STAFF RECOMMENDATION:

N/A

FINANCIAL IMPACT:

N/A

MOTION(S):

N/A

Attachments

[2026 Crime Victims Week.pdf](#)



Proclamation

National Crime Victims' Rights Week in Cibolo, Texas - April 19–25, 2026

Whereas, millions of Americans are victims of crime each year, and these crimes also affect family members, friends, neighbors, and co-workers; and

Whereas, crime can leave a lasting physical, emotional, or financial impact on people of all ages and abilities, and of all economic, racial, and social backgrounds; and

Whereas, in 1984, the Crime Victims Fund was established by the Victims of Crime Act (VOCA) to provide a permanent source of support for crime victim services and compensation through fines and penalties paid by convicted federal offenders; and

Whereas, the Crime Victims Fund today supports thousands of victim assistance programs who provide help and support to child victims of violence and sexual abuse; stalking victims; survivors of homicide victims; victims of drunk-driving crashes; and victims of domestic, dating, and sexual violence and other crimes; and

Whereas, by ensuring that federal offender criminal fines and penalties are deposited into the Crime Victims Fund, Congress affirmed that those who commit crimes should be held accountable for the impact of their actions; and

Whereas, the Crime Victims Fund provides victim assistance to millions of crime victims annually and also provides compensation funds to thousands of crime victims each year for reimbursement of expenses related to their victimization; and

Whereas, the victim assistance community faces new challenges to reach and serve all victims, including victims of newly recognized crimes; and

Whereas, now is the time to embrace a new emphasis on learning what works in reaching underserved victims and meeting victims' needs; and

Whereas, National Crime Victims' Rights Week, provides an opportunity to celebrate the energy, creativity, and commitment that launched the victims' rights movement, inspired its progress, and continues to advance the cause of justice for crime victims; and

Whereas, Advocates are joining forces with victim service providers, criminal justice agencies, and concerned citizens throughout The City of Cibolo and America to raise awareness of victims' rights and observe National Crime Victims' Rights Week.

Now Therefore, Be It Resolved, in official recognition, the City of Cibolo hereby proclaims the week of April 19-25, 2026 as National Crime Victims' Rights Week in Cibolo, Texas, and reaffirms the City's commitment to respect and enforce victims' rights and address victims' needs during National Crime Victims' Rights Week and throughout the year; and express our appreciation for those victims and crime survivors who have turned personal tragedy into a motivating force to improve our response to victims of crime and build a more just community.

In Witness Whereof, I have here unto set my hand this 14th day of **April 2026**.

Kara Latimer, Mayor
City of Cibolo



City Council Regular Meeting Staff Report

C. Child Abuse Prevention & Awareness Month (Ms. Meehan/Ms. Williams)

Meeting	Agenda Group
Tuesday, April 14, 2026, 6:30 PM	Proclamations Item: 5C.
From	
Valerie Chapman, City Secretary	

PRIOR CITY COUNCIL ACTION:

N/A

BACKGROUND:

N/A

STAFF RECOMMENDATION:

N/A

FINANCIAL IMPACT:

N/A

MOTION(S):

N/A

Attachments

[Child Abuse Prevention & Awareness Month April 2026.pdf](#)



Proclamation Child Abuse Prevention & Awareness Month

Whereas, more than 33,249 cases of child abuse and neglect were confirmed in Texas during fiscal year 2025; and

Whereas, there were 163 confirmed victims of child abuse and neglect in Guadalupe County in fiscal year 2025; and

Whereas, child abuse prevention is a community responsibility and finding solutions depends on involvement among all people; and

Whereas, communities must make every effort to promote and support programs that benefit children and their families; and

Whereas, effective child abuse prevention programs succeed because of partnerships among a variety of entities including but not limited to schools, religious organizations, law enforcement agencies, child protective services, prosecution agencies, medical professionals, mental health professionals, SJRC Texas-Belong, the Guadalupe County Child Welfare Board, Children's Advocacy Centers, Court Appointed Special Advocates, Bikers Against Child Abuse, and other community-based non-profit organizations; and

Whereas, everyone in the community should become more aware of child abuse prevention and consider helping parents raise their children in safe, nurturing environments as well as supporting local professionals dedicated to meeting the needs of child abuse victims; and

Now Therefore, Be It Resolved, in official recognition, the City of Cibolo hereby proclaims April 2026 as Child Abuse Prevention & Awareness Month in Cibolo, Texas, and urge all citizens to work together to reduce child abuse and neglect and to significantly improve the response of our community when child abuse occurs in the months and years ahead.

In Witness Whereof, we have here unto set our hand this 14th day of **April 2026**

Kara Latimer, Mayor
City of Cibolo



City Council Regular Meeting Staff Report

A. Presentation from Schertz Cibolo Universal City (SCUC) Independent School District (ISD) about the 2026 Bond for SCUC ISD. (Paige Meloni, SCUC ISD Superintendent)

Meeting	Agenda Group
Tuesday, April 14, 2026, 6:30 PM	Strategic Partnership Presentations Item: 7A.
From	
Wayne Reed, City Manager	

PRIOR CITY COUNCIL ACTION:

N/A

BACKGROUND:

N/A

STAFF RECOMMENDATION:

N/A

FINANCIAL IMPACT:

N/A

MOTION(S):

N/A

Attachments

[SCUC ISD Bond 2026 Presentation 2026-04-14](#)

▶ BOND 2026

SCUC

SCHERTZ - CIBOLO - UNIVERSAL CITY ISD



BOND '26



BOND 2026

WHAT IS A **BOND ELECTION?**

Voters allow the district to borrow money for school construction, renovations, safety, and technology.

HOW **BOND ELECTIONS** **WORK?**

Funds are repaid over time with interest—similar to a home mortgage.

WHY **HOLD A BOND ELECTION?**

The State does not provide funds for large facility projects and those projects cannot typically be paid for from the general fund.

PROP OVERVIEW

SCUC ISD BOND

May 2, 2026 - Election Day

Based on the **recommendation of the district's Community Advisory Committee**, the SCUC Board of Trustees has called a three-proposition bond election.

The **\$295 million bond proposal** includes upgrades and renovations to general facilities across the district, as well as improvements to stadium facilities and the purchase of technology devices.



Prop A
General Facilities
\$230.7 million



Prop B
Stadium Facilities
\$55.3 million



Prop C
Technology Devices
\$9.1 million

Prop A

GENERAL FACILITIES

Proposes \$230.7 million to support district-wide improvements such as campus security systems, classrooms and learning spaces, upgraded fine arts, physical education, and play areas, and campus renovations at multiple grade levels.



Prop B

STADIUM FACILITIES

Proposes \$55.3 million for renovations at Lehnhoff Stadium to expand capacity and upgrade safety, security, concessions, restrooms, lighting, sound systems, and the scoreboard. Additionally, this proposition includes replacing the stadium artificial turf at Steele High School and installing new stadium artificial turf at Corbett Junior High.



Prop C

TECHNOLOGY DEVICES

Proposes \$9.1 million for technology replacement, specifically funding new computers, iPads, and Chromebooks for both students and staff.

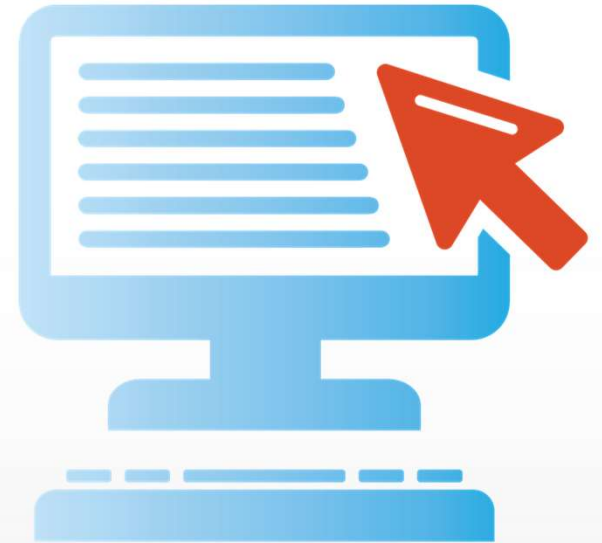

BOND 2026

SCHOOL FINANCE 101

Maintenance & Operations

People and Programs

The M&O tax funds the day-to-day operations of a school district, including staff salaries, student programs, utilities, and other ongoing expenses.



Interest and Sinking

Bonds and Buildings

The I&S tax is used to repay voter-approved bonds that fund school buildings, major renovations, land purchases, and other long-term capital projects.





When added together, M&O and I&S make up the school tax rate that shows up on your property tax bill.

SCUC ISD TAX HISTORY

2020-2021 Through Current

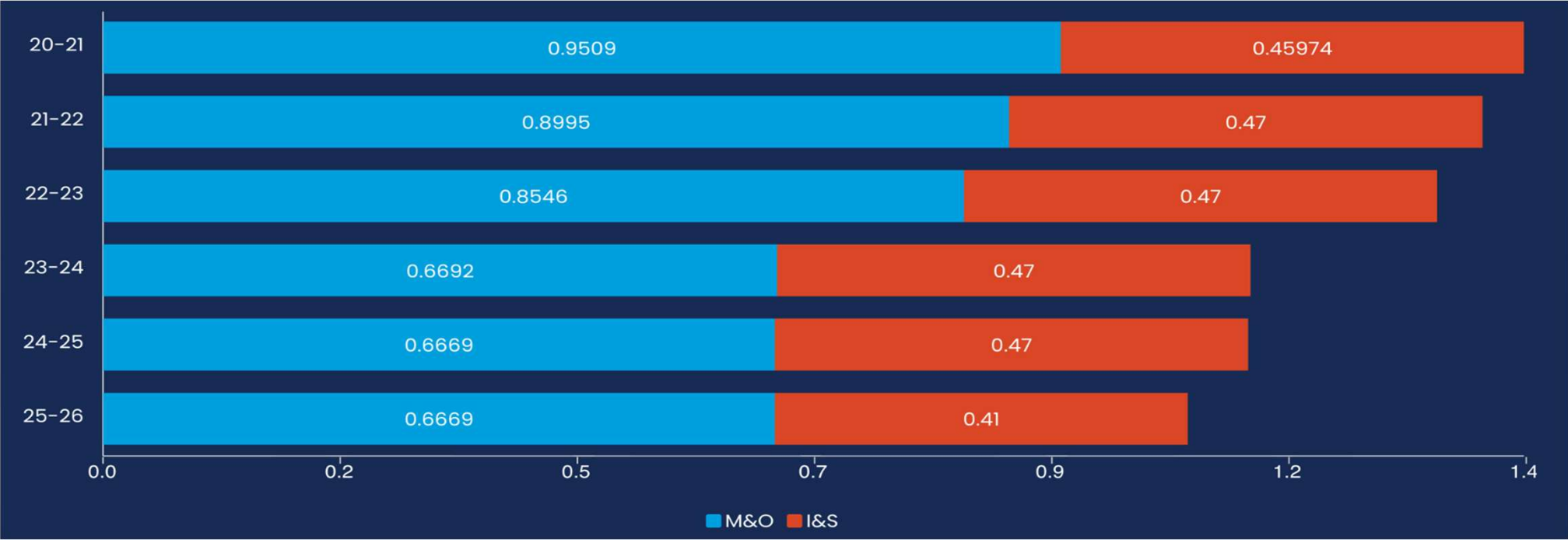

Since 2020–2021, the SCUC ISD tax rate has decreased 33 cents. This change reflects intentional adjustments by the Board of Trustees along with tax rate compression from the State of Texas.

BALLOT LANGUAGE



Texas law mandates that all school bond ballots state **“THIS IS A PROPERTY TAX INCREASE”** even if your tax rate will remain the same.

The May 2026 SCUC ISD bond proposal is not anticipated to affect your 2026-2027 tax rate.

▶ HOMEOWNERS OVER 65

May 2, 2026 - Election Day

While this election does not anticipate a tax rate increase in 2026-2027, it is important to know that citizens age 65 or older will not be affected by this or any school bond election.

State law caps school taxes for residents 65 or older at the amount paid in the first year after they turned 65, unless significant improvements have been made to their homestead.



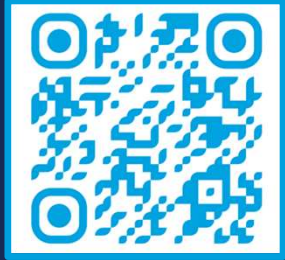

MORE INFO?
bond.scucisd.org

QUESTIONS?
Email: Bond@scucisd.org

BOND 2026

SCUC

SCHERTZ - CIBOLO - UNIVERSAL CITY ISD



BOND '26



City Council Regular Meeting Staff Report

A. Approval of the minutes from the March 7, 2026, Council Workshop

Meeting	Agenda Group
Tuesday, April 14, 2026, 6:30 PM	Consent Agenda - Consent Items (General Items) Item: 8A.
From	
Valerie Chapman, City Secretary	

PRIOR CITY COUNCIL ACTION:

N/A

BACKGROUND:

N/A

STAFF RECOMMENDATION:

N/A

FINANCIAL IMPACT:

N/A

MOTION(S):

N/A

Attachments

[030726 Council WS Minutes.pdf](#)



Minutes for the City Council/Planning & Zoning Commission Workshop

200 S. Main St., Cibolo, Texas 78108

March 7, 2026, 10:03 AM - March 7, 2026, 1:08 PM

1. Call to Order

Mayor Latimer called the workshop to order at 10:03a.m.

2. Roll Call and Excused Absences

Councilmembers Present: Mayor Latimer, Patterson, Sanchez-Stephens, D. Roberts, and Brown. Members Absent: McGlothin, R. Roberts, and Cunningham. Councilwoman D. Roberts made the motion to excuse the absence of Councilmembers McGlothin, R. Roberts, and Cunningham. Motion was seconded by Councilwoman Patterson. For: All; Against: None. Motion carried 4 to 0.

3. Discussion/Action

3.A. Discussion/Work on Performing a Trend Analysis to examine and reflect on the organization and community - what has happened, is happening, and might perhaps happen in a desired future.

Mr. Reed facilitated a Trend Analysis with the Council on Strengths and Weaknesses from the Past, Present, and Future.

4. Adjournment

Councilwoman made the motion to adjourn the meeting at 1:08p.m. Motion was seconded by Councilwoman Sanchez-Stephens. For: All; Against: None. Motion carried 4 to 0.

PASSED AND APPROVED THIS 14TH DAY OF APRIL.

Kara Latimer
Mayor

ATTEST:

Valerie A. Chapman
City Secretary



City Council Regular Meeting Staff Report

B. Approval of the minutes from the March 24, 2026, joint workshop.

Meeting	Agenda Group
Tuesday, April 14, 2026, 6:30 PM	Consent Agenda - Consent Items (General Items) Item: 8B.
From	
Valerie Chapman, City Secretary	

PRIOR CITY COUNCIL ACTION:

N/A

BACKGROUND:

N/A

STAFF RECOMMENDATION:

N/A

FINANCIAL IMPACT:

N/A

MOTION(S):

N/A

Attachments

[032426 Council and PZ WS Minutes.pdf](#)



Minutes for the City Council/Planning & Zoning Commission Workshop

200 S. Main St., Cibolo, Texas 78108

March 24, 2026, 5:31 PM - March 24, 2026, 6:21 PM

1. Call to Order

Mayor Latimer and Ms. Fishback called the workshop to order at 5:31p.m.

2. Roll Call and Excused Absences

Councilmembers Present: Mayor Latimer, McGlothin, Patterson, Cunningham (arrived 5:53p.m.), Sanchez-Stephens, D. Roberts, and Brown.

Planning & Zoning Commissioners Present: Greve (arrived 5:47p.m.), Fishback, Hubbard, Msengi, Browne, and Sharpe.

Councilman McGlothin made the motion to excuse Councilman R. Roberts. Motion was seconded by Councilwoman Brown. For: All; Against: None. Motion carried 6 to 0.

Commissioner Fishback made the motion to excuse Commissioners Dodd and Garcia. Motion was seconded by Commissioner Sharpe. For: All; Against: None. Motion carried 6 to 0.

3. Discussion/Action

3.A. Discussion/Direction on Negotiations with Mosaic Land Development, LLC, on Proposed Development located in the City of Cibolo's ETJ, including a Strategic Partnership Agreement and a Development Agreement

Council, Planning and Zoning Commission, and the developers from Mosaic Land Development, LLC discussed the proposed Development Agreement and Strategic Partnership Agreement for a proposed development in the City of Cibolo's ETJ.

4. Adjournment

Councilwoman Roberts made the motion to adjourn the meeting at 6:21p.m. Motion was seconded by Councilwoman Cunningham. For: All; Against: None. Motion carried 6 to 0.

Commissioner Fishback made the motion to adjourn the meeting at 6:21p.m. Motion was seconded by Commissioner Hubbard. For: All; Against: None. Motion carried 6 to 0.

PASSED AND APPROVED THIS 14TH DAY OF APRIL 2026.

Kara Latimer

Mayor

PASSED AND APPROVED THIS 13TH DAY OF MAY 2026.

Jennifer Greve

P&Z Chair



City Council Regular Meeting Staff Report

C. Approval of the minutes from the March 28, 2026, Strategic Management Workshop.

Meeting	Agenda Group
Tuesday, April 14, 2026, 6:30 PM	Consent Agenda - Consent Items (General Items) Item: 8C.
From	
Valerie Chapman, City Secretary	

PRIOR CITY COUNCIL ACTION:

N/A

BACKGROUND:

N/A

STAFF RECOMMENDATION:

N/A

FINANCIAL IMPACT:

N/A

MOTION(S):

N/A

Attachments

[032826 Council Strategic Management Workshop Minutes.pdf](#)



Minutes for the City Council Strategic Management Workshop

203. S Main, Cibolo, TX 78108

March 28, 2026, 8:49 AM - March 28, 2026, 4:11 PM

1. Call to Order

Workshop was called to order by Mayor Latimer at 8:49a.m. Members Present: Mayor Latimer, Councilmembers: McGlothlin, R. Roberts, Cunningham, Sanchez-Stephens, D. Roberts, and Brown.

2. Workshop Overview

Mr. Reed gave an overview of the workshop with the theme of "Recasting Your Vision".

3. Opening Remarks (8:30AM - 9:00AM)

Mayor Latimer delivered her philosophy on leadership focusing on Trust and "What is Your Why?".

3.A. Mayor's Leadership Philosophy

4. Trend Analysis Recap (9:00AM - 9:50AM)

Mr. Reed recapped the Trend Analysis with Council.

5. Morning Break: Community Engagement - Easter Egg Hunt (9:50AM - 10:20AM)

Mayor Latimer called for a break at 9:50a.m. to attend the Easter Egg Hunt at the MEC. Meeting was reconvened by Mayor Latimer at 10:34a.m.

6. Problem Space to Solution Space (10:30AM - 11:30AM)

6.A. Stormwater Management

Mr. Reed facilitated a discussion on Stormwater Management with Council and Saif Al Haddad.

6.B. Growth and Development

This item was tabled due to time constraints.

7. Working Lunch (11:30AM - 12:45PM)

7.A. Core Strategies Initiative Review

Mr. Reed went over the Core Strategies Initiative with Council.

8. 2025 Strategic Plan Accomplishments (12:45PM - 1:45PM)

Each Department gave examples to Council of their accomplishments in the past year.

9. Investments for the Future (1:45PM - 3:15PM)

Mr. Gomez briefed Council on Parks, Roads, the 5-Year CIP Plan, the Public Safety Facility & Animal Services Facility, and the South CCN Update & Project #1 Next Steps.

9.A. Parks

9.B. Roads

9.C. 5-Year CIP Plan Review

9.D. Public Safety Facility & Animal Services Facility

9.E. South CCN Update & Project #1 Next Steps

10. Future State & Workshop Kick-Off (3:15PM - 4:15PM)

10.A. Budget Discussion Kick-Off

Mr. Reed briefed council on the upcoming budget workshops.

10.B. Visioning: Purpose, Challenges, and Future State

Mr. Reed facilitated a discussion on Visioning: Purpose, Challenges, and Future State.

11. Closing & Evaluation (4:15PM - 4:30PM)

11.A. Plus/Delta

Council discussed with Mr. Reed what they felt went well with the Workshop and what they felt could be improved for the next one.

12. Adjournment

Councilwoman Cunningham made the motion to adjourn the workshop at 4:11p.m. Motion was seconded by Councilman McGlothin. For: All; Against: None. Motion carried 6 to 0.

PASSED AND APPROVED THIS 14TH DAY OF APRIL 2026.

Kara Latimer

Mayor

ATTEST:

Valerie A. Chapman, TRMC
City Secretary



City Council Regular Meeting Staff Report

D. Approval of the minutes from the March 24, 2026, regular Council meeting.

Meeting	Agenda Group
Tuesday, April 14, 2026, 6:30 PM	Consent Agenda - Consent Items (General Items) Item: 8D.
From	
Valerie Chapman, City Secretary	

PRIOR CITY COUNCIL ACTION:

N/A

BACKGROUND:

N/A

STAFF RECOMMENDATION:

N/A

FINANCIAL IMPACT:

N/A

MOTION(S):

N/A

Attachments

[032426 Council Minutes.pdf](#)



Minutes for the City Council Regular Meeting

200 S. Main St., Cibolo, Texas 78108

March 24, 2026, 6:35 PM - March 24, 2026, 10:18 PM

1. Call to Order

Mayor Latimer called the meeting to order at 6:35p.m.

2. Roll Call and Excused Absences

Councilmembers present: McGlothin, Patterson, Cunningham, Mayor Latimer, Sanchez-Stephens, D. Roberts, and Brown. Councilmember absent: R. Roberts. Councilwoman Cunningham made the motion to excuse Councilman Roberts' absence. Motion was seconded by Councilwoman Patterson. For: All; Against: None. Motion carried 6 to 0.

3. Invocation

Invocation was given by Chaplain Ray Huff.

4. Pledge of Allegiance

All in attendance recited the Pledge of Allegiance.

5. Presentation of Awards/Recognitions

5.A. Recognition of Fire Department staff for their actions at 513 Zoeller Way on January 29, 2026, during a structure fire with a trapped occupant.

Chief Troncoso presented awards to Fire Department staff for their actions rescuing a trapped occupant on January 19, 2026.

6. Proclamations

6.A. Proclamation for Horizon Pregnancy Resources

Councilwoman Sanchez-Stephens read and presented the proclamation to Horizon Pregnancy Resources.

6.B. Proclamation for Evelyn Beulah Wilson Metoyer Pierce 100th Birthday

Councilwoman Brown read and presented the proclamation to Ms. Pierce for her 100th birthday.

7. Citizens to be Heard

Ms. Amie Reynolds spoke on her support as a member of the Chamber for the EDC EDGE grants for Max and Louie's and Ace Hardware.

Mr. Mike Eklund, owner of Ace Hardware, spoke on his family, how they decided to open an Ace Hardware, why they chose Cibolo to open it, and how they would put the EDC Edge grant to use.

Ms. Shari McDaniel spoke on her support of reconsidering Councilwoman Roberts as the City's CRWA Board of Trustees member. She has worked with Councilwoman Roberts and believes continuity would be best for the position.

Mr. Drew Glick, owner of Max and Louie's, spoke on his gratitude for the help from City staff, how he ended up in the San Antonio area, what made him want to open a location in Cibolo, how they operate, and how he would put the EDC Edge grant to use.

Mayor Latimer read an e-mail from Ms. Courtney Kempe regarding two easements left to the Saddle Creek Ranch HOA by the developer without their consent. The developer left the containment barriers which damages their landscapers equipment. Mr. Reed requested the e-mail and information so the Public Works Department can go out and remove the barriers for the HOA.

8. Consent Agenda - Consent Items (General Items)

Councilwoman Roberts made a motion to approve the consent agenda with the correction to the workshop minutes title removing the Planning & Zoning as it was not a joint workshop. Motion was seconded by Councilwoman Sanchez-Stephens. For: All; Against: None. Motion carried 6 to 0.

8.A. Approval of the January 2026 Revenue & Expense Report pending final acceptance of the City's financial audit for the 25-26 fiscal year.

8.B. Approval of the January 2026 Check Register

8.C. Approval of the minutes from the Regular Council meeting on March 10, 2026.

8.D. Approval of the minutes from the City Council Workshop on March 10, 2026.

9. Mayor Follow-Up

9.A. Union Pacific sidewalk across railroad track on Main St.

Mr. Reed to give an update during Staff Update.

9.B. Regional Outreach

Mayor Latimer spoke about regional outreach and how Council needs to be actively involved with the City's regional partners.

9.C. Viewing Meeting Information in Agendalink

Mayor Latimer wanted to make sure Council and the public understood how to be able to view the agendas and supporting documents. Mr. Beekman gave a short presentation on agendalink and its capabilities.

9.D. Saddle Creek Ranch

Mayor Latimer spoke about the importance of reviewing the water shed. The city needs to provide all information it has on drainage in this area and asking for help from the water shed authority.

10. Staff Update

10.A. Administration

Staff is working with consultant on revisions to the plans for the sidewalk over the railroad on Main St. and will submit to UPRR and schedule a follow-up meeting.

Staff will present recommendations to Council in April on Phase I of renovations to Niemietz and Veterans parks.

Community Center Phase II design is being reviewed by staff and will go out to bid once completed.

No staff travel at this time.

Mr. Reed reminded Council of the Strategic Management Workshop with a break for the Council to attend the beginning of the Easter Egg Hunt.

10.B. Police Department Monthly Report (February)

10.C. Fire Department Monthly Report (February)

11. Resolutions

11.A. Approval/Disapproval of Resolution of the City of Cibolo, Texas, appointing Mayor Kara Latimer to Canyon Regional Water Authority (CRWA) Board of Trustees for a two-year term of office. (Mr. Reed)

Councilwoman Brown made the motion to approve the resolution as written. Motion was seconded by Councilwoman Sanchez-Stephens. For: Councilmembers: Brown and Sanchez-Stephens; Against: Councilmembers: McGlothlin, Patterson, Cunningham, D. Roberts. Motion failed 2 to 4.

Councilman McGlothlin made the motion to approve the resolution with Councilwoman Roberts in place as the appointed CRWA Board of Trustee member. Motion was seconded by Councilwoman Roberts. For: Councilmembers: McGlothlin, Patterson, Cunningham, D. Roberts; Against: Councilwoman Sanchez-Stephens and Councilwoman Brown. Motion carried 4 to 2.

11.B. Approval/Disapproval of a Resolution of the City of Cibolo, Texas, appointing Chris Hubbard to Canyon Regional Water Authority (CRWA) Board of Managers for a one-year term of office. (Mr. Reed)

Councilwoman Sanchez-Stephens made a motion to approve the resolution replacing Chris Hubbard with Saif Al Haddad as the City's representative to the CRWA Board of Managers. Motion was seconded by Councilwoman Roberts. For: All; Against: None. Motion carried 6 to 0.

11.C. Approval of a Resolution by the City of Cibolo, regarding the Interim Rate Adjustment application of Centerpoint Energy for the 12 month period ending December 31, 2025.

Councilwoman Roberts made the motion to approve the resolution. Motion was seconded by Councilwoman Sanchez-Stephens. For: Councilmembers: McGlothlin, Patterson, Sanchez-Stephens, D. Roberts, and Brown; Against: None; Absent: Councilwoman Cunningham. Motion carried 5 to 0.

11.D. Approval/Disapproval of a Resolution of the City of Cibolo, Texas, Accepting the Dedication of Four Tracts of Real Property Consisting in Total of Approximately 12.42 acres, and Located in the Block 5 of the Foxbrook Subdivision in the City of Cibolo.

Councilwoman Sanchez-Stephens made the motion to approve the resolution. Motion was seconded by Councilwoman Brown. For: All; Against: None. Motion carried 6 to 0.

12. Discussion/Action

12.A. Discussion / Presentation on the Cibolo Youth Advisory Council's attendance at the YAC Summit. (Mr. Huggins)

Mr. Huggins gave a presentation to Council on the YAC Summit and the Youth Council's activities while in attendance. Adalynn Lampkin from the Youth Council shared her experience at the YAC Summit.

12.B. Discussion/Action on the Historic Committee Projects for FY 25/26. (Ms. Tudyk/Ms. Beach)

Councilwoman Cunningham made the motion to approve funds up to \$350 for the Historic Committee to purchase paint and supplies for their flowerpot and mural projects. Motion was seconded by Councilwoman Brown. For: All; Against: None. Motion carried 6 to 0.

12.C. Discussion/Action approval of Guadalupe Master Gardeners to host a Special Event plant sale and market at the Community Garden in accordance with Municode Chapter 54, sec 54-106 (Ms. Hernandez/Guadalupe Master Gardners)

Councilwoman Sanchez-Stephens made the motion to approve item 12C as written. Motion was seconded by Councilwoman Patterson. For: All; Against: None. Motion carried 6 to 0.

12.D. Presentation/Discussion/Action on the Annual Comprehensive Financial Report for fiscal year ended September 30, 2025. (Ms. Miranda)

Mr. Jacob Twomey with Armstrong, Vaughan & Associates gave Council a presentation on the Annual Comprehensive Financial Report for fiscal year ended September 30, 2025.

12.E. Discussion/Action regarding the Final Plat of Cibolo Farms Unit 4. (Mr. Spencer)

Councilwoman Cunningham made the motion to approve the final plat of Cibolo Farms Unit 4. Motion was seconded by Councilwoman Roberts. For: Councilmembers: McGlothlin, Patterson, Cunningham, D. Roberts, Brown; Against: Councilwoman Sanchez-Stephens. Motion carried 5 to 1.

12.F. Discussion/Action to approve a CEDC EDGE Grant for Max and Louie's New York Diner in the not to exceed amount of \$50,000 (Mr. Hardin)

Councilwoman Patterson made the motion to approve a CEDC EDGE Grant for Max and Louie's New York Diner in the amount not to exceed \$50,000. Motion was seconded by Councilman McGlothlin. For: All; Against: None; Absent: Councilwoman Brown. Motion carried 5 to 0.

12.G. Discussion/Action to approve a CEDC EDGE Grant for Ace River City in the not to exceed amount of \$50,000 (Mr. Hardin)

Councilwoman Sanchez-Stephens made the motion to approve a CEDC EDGE Grant for Ace River City in the amount not to exceed \$50,000. Motion was seconded by Councilwoman Patterson. For: All; Against: None. Motion carried 6 to 0.

12.H. Discussion/Action on the reconsideration of the CRWA Board of Trustees nominee. (Councilwoman Roberts)

Councilwoman Roberts nominated herself to serve on the CRWA Board of Trustees for a two-year term. Motion was seconded by Councilman McGlothlin. For: Councilmembers: McGlothlin, Patterson, Cunningham, D. Roberts. Against: Councilwomen Sanchez-Stephens and Brown. Motion carried 4 to 2.

12.I. Discussion/Direction to City Manager on email notification to Council of potential issues within the City and press release responses to media reports. (Councilwoman Roberts)

Mr. Reed will work with City Attorney to create a written policy on response to media reports.

12.J. Approval and Authorizing the City Manager to execute an Agreement for City Engineering Services and related Task Orders to provide engineering services for Land Development Applications and Land Development Related Special Projects. (Mr. Reed)

Councilwoman Cunningham made the motion to approve the item as written. Motion was seconded by Councilman McGlothlin. For: Councilmembers: McGlothlin, Patterson, Cunningham, and D. Roberts; Against: Councilwomen Sanchez-Stephens and Brown. Motion carried 4 to 2.

12.K. Discussion/Action on Celebrating America's 250th Birthday. (Mr. McGlothlin)

Councilwoman Cunningham made the motion to assign the project of celebrating America's 250th Birthday to the Parks Commission. Motion was seconded by Councilman McGlothlin. For: All; Against: None; Absent: Councilwoman D. Roberts. Motion carried 5 to 0.

12.L. Discussion/Presentation on Council's Trend Analysis and the Strategic Management Workshop. (Mr. Reed)

Mr. Reed gave a briefing on the Council's Trend Analysis and the Strategic Management Workshop.

12.M. Discussion from Councilmembers that have attended seminars, events, or meetings. (Council)

Councilwoman Patterson attended the NEP Luncheon, Chamber Luncheon, CIP Subcommittee meeting, Women's History Month Luncheon, Max and Louie's walk-through, Raise Your Hand Texas Community Leaders Meeting, Fountain of Life Community Church Groundbreaking, and SAWS tour.

Councilwoman Cunningham attended the school district's Community Advisory Committee meeting and CIP Subcommittee meeting.

Councilwoman Sanchez-Stephens attended the Max and Louie's walk-through, Fountain of Life Church Groundbreaking, BVYA Opening Day parade and ceremony, Women's Appreciation Luncheon, Horizon Pregnancy Resource Center tour, Chamber Luncheon, SAWS tour, and San Antonio Women's Hall of Fame.

Councilwoman Roberts attended the NEP Luncheon.

Councilwoman Brown attended the Women's Appreciation Luncheon, Chamber Luncheon, Max and Louie's tour, SAWS tour, and Horizon Pregnancy Resource Center tour.

Mayor Latimer attended the Chamber Luncheon, NEP Luncheon, Women's Appreciation Luncheon, Ordinance Subcommittee, and BVYA Opening Day parade and ceremony.

12.N. Discussion on items the City Council would like to see on future agendas. (Council)

Councilwoman Roberts wants a standing topic on every month's second meeting agenda to present a report on CRWA updates.

Councilwoman Cunningham would like a presentation from Waste Connections on recycling and other services.

12.O. Discussion/Action on the review and confirmation of all upcoming special meetings and workshops and scheduling the time, date and place of additional special meetings or workshops. (Ms. Chapman)

Ms. Chapman will notify Council of any upcoming new meetings or events.

13. Adjournment

Councilwoman Roberts made the motion to adjourn the meeting. Motion was seconded by Councilwoman Patterson. For: All; Against: None. Motion carried 6 to 0.

PASSED AND APPROVED THIS 14TH DAY OF APRIL 2026.

Kara Latimer
Mayor

ATTEST:

Valerie A. Chapman, TRMC
City Secretary



City Council Regular Meeting Staff Report

B. Police Department

Meeting	Agenda Group
Tuesday, April 14, 2026, 6:30 PM	Staff Update Item: 10B.
From	
Leigh Ann Rogers, Executive Assistant to the Chief of Police	

PRIOR CITY COUNCIL ACTION:

N/A

BACKGROUND:

N/A

STAFF RECOMMENDATION:

N/A

FINANCIAL IMPACT:

N/A

MOTION(S):

N/A

Attachments

[CPD Monthly Calls for Service Log March 2026.pdf](#)
[03.2026.pdf](#)



Cibolo Police Department Report Call Summary Results



Agency: CPD
Agency #: TX0940600

Print Date/Time: 04/01/2026 08:06
Total Records : 977

Incident Number	Incident Type	Call Date/Time	Location Street Name	Area PD Response Areas
Incident Type: 911 Hang Up/Open Line (15)				
2026-00011806	911 Hang Up/Open Line	03/03/2026 10:05	BOLTON RD	Cibolo (6)
2026-00014953	911 Hang Up/Open Line	03/20/2026 08:22	CIBOLO DR	Cibolo (5)
2026-00017146	911 Hang Up/Open Line	03/31/2026 18:51	FM 1103	Cibolo (5)
2026-00015288	911 Hang Up/Open Line	03/21/2026 20:34	WATSON WAY	Cibolo (3)
2026-00014866	911 Hang Up/Open Line	03/19/2026 17:40	DEER MESA	Cibolo (3)
2026-00011701	911 Hang Up/Open Line	03/03/2026 01:43	CIBOLO VALLEY DR	Cibolo (3)
2026-00013270	911 Hang Up/Open Line	03/11/2026 10:10	TURNBERRY WAY	Cibolo (3)
2026-00011802	911 Hang Up/Open Line	03/03/2026 09:49	DEER MEADOW BLVD	Cibolo (3)
2026-00012523	911 Hang Up/Open Line	03/06/2026 20:20	FARMVIEW	Cibolo (4)
2026-00012571	911 Hang Up/Open Line	03/07/2026 00:14	HANOVER PLACE	Cibolo (4)
2026-00011594	911 Hang Up/Open Line	03/02/2026 16:05	NIEMIETZ CV	Cibolo (4)
2026-00012059	911 Hang Up/Open Line	03/04/2026 12:23	NIEMIETZ CV	Cibolo (4)
2026-00015402	911 Hang Up/Open Line	03/22/2026 14:26	S WILLOW WAY	Cibolo (1)
2026-00013864	911 Hang Up/Open Line	03/14/2026 17:39	WILLOW VW	Cibolo (1)
2026-00012348	911 Hang Up/Open Line	03/05/2026 22:20	PIONEER JUNCTION	Cibolo (2)
Incident Type: Abandoned Vehicle (6)				
2026-00013029	Abandoned Vehicle	03/09/2026 22:37	IH 10 W	Cibolo (6)
2026-00016687	Abandoned Vehicle	03/29/2026 10:44	BRUSH TRAIL BEND	Cibolo (3)
2026-00014239	Abandoned Vehicle	03/16/2026 18:29	CIBOLO VALLEY DR	Cibolo (3)
2026-00012450	Abandoned Vehicle	03/06/2026 13:51	MORGAN RUN	Cibolo (4)
2026-00013955	Abandoned Vehicle	03/15/2026 08:27	BANDANA ST	Cibolo (4)
2026-00014784	Abandoned Vehicle	03/19/2026 09:43	LONGHORN WAY	Cibolo (4)
Incident Type: Accident- Mv Hit & Run (11)				
2026-00013759	Accident- Mv Hit & Run	03/13/2026 21:05	FM 78 E	Cibolo (6)
2026-00013755	Accident- Mv Hit & Run	03/13/2026 20:53	FM 78 W	Cibolo (6)



Cibolo Police Department Report Call Summary Results



Agency: CPD
Agency #: TX0940600

Print Date/Time: 04/01/2026 08:06
Total Records : 977

Incident Number	Incident Type	Call Date/Time	Location Street Name	Area PD Response Areas
2026-00016960	Accident- Mv Hit & Run	03/30/2026 21:36	FM 78 W	Cibolo (6)
2026-00016480	Accident- Mv Hit & Run	03/27/2026 21:30	IH 10 W	Cibolo (6)
2026-00016894	Accident- Mv Hit & Run	03/30/2026 15:28	CIBOLO VALLEY DR	Cibolo (5)
2026-00016888	Accident- Mv Hit & Run	03/30/2026 15:03	FM 1103	Cibolo (5)
2026-00015720	Accident- Mv Hit & Run	03/24/2026 08:16	LOOP 539 E	Cibolo (5)
2026-00017060	Accident- Mv Hit & Run	03/31/2026 10:12	CIBOLO VALLEY DR	Cibolo (5)
2026-00014195	Accident- Mv Hit & Run	03/16/2026 14:25	FM 1103	Cibolo (5)
2026-00012439	Accident- Mv Hit & Run	03/06/2026 12:45	CIBOLO VALLEY DR	Cibolo (3)
2026-00012634	Accident- Mv Hit & Run	03/07/2026 11:16	GREEN VALLEY RD	Cibolo (4)
Incident Type: Accident- Mv No Injury (42)				
2026-00014049	Accident- Mv No Injury	03/15/2026 20:21	FM 78 W	Cibolo (6)
2026-00013852	Accident- Mv No Injury	03/14/2026 15:53	IH 10 W	Cibolo (6)
2026-00012754	Accident- Mv No Injury	03/08/2026 01:29	IH 10 W	Cibolo (6)
2026-00011795	Accident- Mv No Injury	03/03/2026 09:16	FM 78 W	Cibolo (6)
2026-00012085	Accident- Mv No Injury	03/04/2026 15:30	FM 78 W	Cibolo (6)
2026-00012537	Accident- Mv No Injury	03/06/2026 21:03	FM 78 W	Cibolo (6)
2026-00014300	Accident- Mv No Injury	03/17/2026 01:54	IH 10 W	Cibolo (6)
2026-00014600	Accident- Mv No Injury	03/18/2026 11:15	IH 10 W	Cibolo (6)
2026-00015826	Accident- Mv No Injury	03/24/2026 17:52	BOLTON RD	Cibolo (6)
2026-00016782	Accident- Mv No Injury	03/30/2026 05:51	BOLTON RD	Cibolo (6)
2026-00015294	Accident- Mv No Injury	03/21/2026 21:14	CIBOLO VALLEY DR	Cibolo (5)
2026-00013681	Accident- Mv No Injury	03/13/2026 13:37	FM 1103	Cibolo (5)
2026-00015958	Accident- Mv No Injury	03/25/2026 11:41	CIBOLO VALLEY DR	Cibolo (5)
2026-00011608	Accident- Mv No Injury	03/02/2026 17:43	W BORGFELD RD	Cibolo (5)
2026-00011620	Accident- Mv No Injury	03/02/2026 18:51	CIBOLO VALLEY DR	Cibolo (5)



Cibolo Police Department Report Call Summary Results



Agency: CPD
Agency #: TX0940600

Print Date/Time: 04/01/2026 08:06
Total Records : 977

Incident Number	Incident Type	Call Date/Time	Location Street Name	Area PD Response Areas
2026-00012674	Accident- Mv No Injury	03/07/2026 16:55	CIBOLO VALLEY DR	Cibolo (5)
2026-00013791	Accident- Mv No Injury	03/14/2026 02:38	CIBOLO VALLEY DR	Cibolo (5)
2026-00015018	Accident- Mv No Injury	03/20/2026 15:03	CIBOLO VALLEY DR	Cibolo (5)
2026-00013389	Accident- Mv No Injury	03/11/2026 23:10	CIBOLO VALLEY DR	Cibolo (5)
2026-00015969	Accident- Mv No Injury	03/25/2026 13:30	CIBOLO VALLEY DR	Cibolo (5)
2026-00016140	Accident- Mv No Injury	03/26/2026 08:33	CIBOLO VALLEY DR	Cibolo (5)
2026-00012986	Accident- Mv No Injury	03/09/2026 15:49	FM 1103	Cibolo (5)
2026-00014186	Accident- Mv No Injury	03/16/2026 12:41	FM 1103	Cibolo (5)
2026-00016269	Accident- Mv No Injury	03/26/2026 20:22	FM 1103	Cibolo (5)
2026-00016420	Accident- Mv No Injury	03/27/2026 15:04	FM 1103	Cibolo (5)
2026-00015640	Accident- Mv No Injury	03/23/2026 19:02	FM 1103	Cibolo (5)
2026-00011777	Accident- Mv No Injury	03/03/2026 07:55	MOHAWK DR	Cibolo (5)
2026-00016433	Accident- Mv No Injury	03/27/2026 16:39	CIBOLO VALLEY DR	Cibolo (5)
2026-00012049	Accident- Mv No Injury	03/04/2026 11:14	FM 1103	Cibolo (5)
2026-00014356	Accident- Mv No Injury	03/17/2026 08:52	KNIGHTS CROSSING	Cibolo (5)
2026-00011609	Accident- Mv No Injury	03/02/2026 17:51	ALDERS GATE	Cibolo (3)
2026-00011772	Accident- Mv No Injury	03/03/2026 07:37	CIBOLO VALLEY DR	Cibolo (3)
2026-00014228	Accident- Mv No Injury	03/16/2026 17:34	GREEN VALLEY RD	Cibolo (3)
2026-00013975	Accident- Mv No Injury	03/15/2026 10:04	GREEN VALLEY RD	Cibolo (4)
2026-00012005	Accident- Mv No Injury	03/04/2026 08:45	FM 1103	Cibolo (4)
2026-00013173	Accident- Mv No Injury	03/10/2026 18:46	IH 35 N	Cibolo (1)
2026-00015234	Accident- Mv No Injury	03/21/2026 13:29	KAYLEE CHASE	Cibolo (1)
2026-00014224	Accident- Mv No Injury	03/16/2026 16:37	TOWER BLF	Cibolo (1)
2026-00016266	Accident- Mv No Injury	03/26/2026 20:00	FM 1103	Cibolo (2)
2026-00015842	Accident- Mv No Injury	03/24/2026 20:09	DEAN RD	Cibolo (2)



Cibolo Police Department Report Call Summary Results



Agency: CPD
Agency #: TX0940600

Print Date/Time: 04/01/2026 08:06
Total Records : 977

Incident Number	Incident Type	Call Date/Time	Location Street Name	Area PD Response Areas
2026-00014016	Accident- Mv No Injury	03/15/2026 14:55	LOWER SEGUIN RD	Guadalupe County
2026-00015400	Accident- Mv No Injury	03/22/2026 14:19	BRITE RD	Guadalupe County
Incident Type: Accident-Mv Inj (16)				
2026-00012966	Accident-Mv Inj	03/09/2026 14:26	FM 78 W	Cibolo (6)
2026-00011569	Accident-Mv Inj	03/02/2026 13:35	FM 1103	Cibolo (6)
2026-00013802	Accident-Mv Inj	03/14/2026 07:28	IH 10 W	Cibolo (6)
2026-00015033	Accident-Mv Inj	03/20/2026 16:19	FM 1103	Cibolo (5)
2026-00011457	Accident-Mv Inj	03/01/2026 19:27	COUNTRY LN	Cibolo (5)
2026-00012001	Accident-Mv Inj	03/04/2026 08:21	FM 1103	Cibolo (5)
2026-00013072	Accident-Mv Inj	03/10/2026 08:10	FM 78 W	Cibolo (5)
2026-00016007	Accident-Mv Inj	03/25/2026 16:53	FM 1103	Cibolo (5)
2026-00011865	Accident-Mv Inj	03/03/2026 14:56	W BORGFELD RD	Cibolo (3)
2026-00014678	Accident-Mv Inj	03/18/2026 17:34	CIBOLO VALLEY DR	Cibolo (3)
2026-00013882	Accident-Mv Inj	03/14/2026 20:18	FM 1103	Cibolo (4)
2026-00013293	Accident-Mv Inj	03/11/2026 11:52	FM 1103	Cibolo (4)
2026-00013761	Accident-Mv Inj	03/13/2026 21:36	WEIL RD	Cibolo (4)
2026-00015413	Accident-Mv Inj	03/22/2026 17:08	CIBOLO VALLEY DR	Cibolo (1)
2026-00012258	Accident-Mv Inj	03/05/2026 10:58	FM 1103	Cibolo (2)
2026-00013726	Accident-Mv Inj	03/13/2026 17:54	TURNING STONE	Cibolo (2)
Incident Type: Accident-Mv/Ped (2)				
2026-00013079	Accident-Mv/Ped	03/10/2026 08:27	BUFFALO CROSSING	Cibolo (5)
2026-00012488	Accident-Mv/Ped	03/06/2026 17:32	ASIAGO	Cibolo (2)
Incident Type: Alarm- Burglary (65)				
2026-00013727	Alarm- Burglary	03/13/2026 18:11	STAG WAY	Cibolo (6)
2026-00012470	Alarm- Burglary	03/06/2026 15:42	STAG WAY	Cibolo (6)
2026-00015276	Alarm- Burglary	03/21/2026 19:39	JANET LN	Cibolo (6)
2026-00015421	Alarm- Burglary	03/22/2026 19:33	JANET LN	Cibolo (6)
2026-00013200	Alarm- Burglary	03/10/2026 22:09	FM 78 E	Cibolo (6)
2026-00014084	Alarm- Burglary	03/16/2026 01:17	FM 78 E	Cibolo (6)
2026-00012608	Alarm- Burglary	03/07/2026 05:35	NAVAJO CIR	Cibolo (5)
2026-00015675	Alarm- Burglary	03/24/2026 00:13	NAVAJO CIR	Cibolo (5)
2026-00015707	Alarm- Burglary	03/24/2026 07:07	NAVAJO CIR	Cibolo (5)
2026-00013291	Alarm- Burglary	03/11/2026 11:40	GULF ST	Cibolo (5)



Cibolo Police Department Report Call Summary

Results



Agency: CPD
Agency #: TX0940600

Print Date/Time: 04/01/2026 08:06
Total Records : 977

Incident Number	Incident Type	Call Date/Time	Location Street Name	Area PD Response Areas
2026-00013317	Alarm- Burglary	03/11/2026 13:54	SLEEPY VILLAGE	Cibolo (5)
2026-00013718	Alarm- Burglary	03/13/2026 16:30	IRON RIVER	Cibolo (5)
2026-00012461	Alarm- Burglary	03/06/2026 14:42	SCHNEIDER DR	Cibolo (5)
2026-00013367	Alarm- Burglary	03/11/2026 21:33	FM 1103	Cibolo (5)
2026-00013382	Alarm- Burglary	03/11/2026 22:12	FM 1103	Cibolo (5)
2026-00014053	Alarm- Burglary	03/15/2026 21:18	FM 1103	Cibolo (5)
2026-00013300	Alarm- Burglary	03/11/2026 12:13	CIBOLO VALLEY DR	Cibolo (5)
2026-00014095	Alarm- Burglary	03/16/2026 04:15	S MAIN ST	Cibolo (5)
2026-00013038	Alarm- Burglary	03/09/2026 23:29	AMBER CRK	Cibolo (5)
2026-00014085	Alarm- Burglary	03/16/2026 01:20	W BORGFELD RD	Cibolo (5)
2026-00014098	Alarm- Burglary	03/16/2026 05:37	GUADALUPE DR	Cibolo (5)
2026-00014238	Alarm- Burglary	03/16/2026 18:29	GUADALUPE DR	Cibolo (5)
2026-00013430	Alarm- Burglary	03/12/2026 04:29	FM 1103	Cibolo (5)
2026-00012313	Alarm- Burglary	03/05/2026 17:33	INDUSTRIAL DR	Cibolo (5)
2026-00012321	Alarm- Burglary	03/05/2026 18:15	INDUSTRIAL DR	Cibolo (5)
2026-00016898	Alarm- Burglary	03/30/2026 15:37	OVERLOOK RDG	Cibolo (5)
2026-00013792	Alarm- Burglary	03/14/2026 03:55	GUADALUPE DR	Cibolo (5)
2026-00014912	Alarm- Burglary	03/20/2026 00:23	GUADALUPE DR	Cibolo (5)
2026-00013631	Alarm- Burglary	03/13/2026 08:49	BALTUSTROL DR	Cibolo (3)
2026-00011952	Alarm- Burglary	03/04/2026 00:42	CARMEL DR	Cibolo (3)
2026-00016817	Alarm- Burglary	03/30/2026 09:34	STORM MT RD	Cibolo (3)
2026-00016133	Alarm- Burglary	03/26/2026 08:16	EGLINGTON WAY	Cibolo (3)
2026-00016413	Alarm- Burglary	03/27/2026 14:24	RIO VISTA DR	Cibolo (3)
2026-00011787	Alarm- Burglary	03/03/2026 08:32	GRAND AVE	Cibolo (3)
2026-00011332	Alarm- Burglary	03/01/2026 07:29	RAMSDALE WAY	Cibolo (4)
2026-00016105	Alarm- Burglary	03/26/2026 05:52	FM 1103	Cibolo (4)
2026-00017166	Alarm- Burglary	03/31/2026 21:17	IH 35 N	Cibolo (1)
2026-00012903	Alarm- Burglary	03/09/2026 03:48	IH 35 N	Cibolo (1)
2026-00012905	Alarm- Burglary	03/09/2026 04:34	IH 35 N	Cibolo (1)
2026-00011306	Alarm- Burglary	03/01/2026 02:36	IH 35 N	Cibolo (1)
2026-00011493	Alarm- Burglary	03/02/2026 05:44	IH 35 N	Cibolo (1)
2026-00012590	Alarm- Burglary	03/07/2026 02:58	IH 35 N	Cibolo (1)
2026-00012610	Alarm- Burglary	03/07/2026 06:45	IH 35 N	Cibolo (1)
2026-00013387	Alarm- Burglary	03/11/2026 23:01	IH 35 N	Cibolo (1)



Cibolo Police Department Report Call Summary Results



Agency: CPD
Agency #: TX0940600

Print Date/Time: 04/01/2026 08:06
Total Records : 977

Incident Number	Incident Type	Call Date/Time	Location Street Name	Area PD Response Areas
2026-00013775	Alarm- Burglary	03/13/2026 23:02	IH 35 N	Cibolo (1)
2026-00013905	Alarm- Burglary	03/14/2026 23:02	IH 35 N	Cibolo (1)
2026-00013948	Alarm- Burglary	03/15/2026 07:56	IH 35 N	Cibolo (1)
2026-00013983	Alarm- Burglary	03/15/2026 10:44	IH 35 N	Cibolo (1)
2026-00014087	Alarm- Burglary	03/16/2026 02:01	IH 35 N	Cibolo (1)
2026-00014089	Alarm- Burglary	03/16/2026 02:15	IH 35 N	Cibolo (1)
2026-00015305	Alarm- Burglary	03/21/2026 22:12	IH 35 N	Cibolo (1)
2026-00015377	Alarm- Burglary	03/22/2026 10:53	BROOK SHADOW	Cibolo (1)
2026-00011543	Alarm- Burglary	03/02/2026 10:39	IH 35 N	Cibolo (1)
2026-00016157	Alarm- Burglary	03/26/2026 09:49	SPRINGTREE BEND	Cibolo (1)
2026-00015741	Alarm- Burglary	03/24/2026 09:53	WILLOW BLF	Cibolo (1)
2026-00014896	Alarm- Burglary	03/19/2026 21:10	BROOK STONE	Cibolo (1)
2026-00015777	Alarm- Burglary	03/24/2026 13:38	BROOK STONE	Cibolo (1)
2026-00014599	Alarm- Burglary	03/18/2026 11:08	WISTORIA CT	Cibolo (1)
2026-00012831	Alarm- Burglary	03/08/2026 20:26	KILKENNY	Cibolo (2)
2026-00014069	Alarm- Burglary	03/15/2026 23:24	LANDMARK HAVEN	Cibolo (2)
2026-00012276	Alarm- Burglary	03/05/2026 13:22	PADOVA	Cibolo (2)
2026-00013295	Alarm- Burglary	03/11/2026 11:58	CAVAN	Cibolo (2)
2026-00013454	Alarm- Burglary	03/12/2026 09:28	SILVER FOX	Cibolo (2)
2026-00014850	Alarm- Burglary	03/19/2026 16:19	SWIFT FOX	Cibolo (2)
2026-00014692	Alarm- Burglary	03/18/2026 20:40	FOXBROOK WAY	Cibolo (2)
Incident Type: Alarm-Robbery/Panic (5)				
2026-00012691	Alarm- Robbery/Panic	03/07/2026 19:10	CANTON CHASE	Cibolo (4)
2026-00012910	Alarm- Robbery/Panic	03/09/2026 07:09	ARCADIA PLACE	Cibolo (4)
2026-00016939	Alarm- Robbery/Panic	03/30/2026 20:09	HEREFORD ST	Cibolo (4)
2026-00017168	Alarm- Robbery/Panic	03/31/2026 21:44	IH 35 N	Cibolo (1)
2026-00016432	Alarm- Robbery/Panic	03/27/2026 16:30	IH 35 N	Cibolo (1)
Incident Type: Animal Call (77)				
2026-00013163	Animal Call	03/10/2026 17:34	JAMIE LYN BLVD	Schertz (501)
2026-00011972	Animal Call	03/04/2026 06:16	IH 10 E	Schertz (510)
2026-00012637	Animal Call	03/07/2026 11:35	IH 10 E	Bexar County
2026-00017057	Animal Call	03/31/2026 09:54	PARK VALLEY DR	Cibolo (6)



Cibolo Police Department Report Call Summary

Results



Agency: CPD
Agency #: TX0940600

Print Date/Time: 04/01/2026 08:06
Total Records : 977

Incident Number	Incident Type	Call Date/Time	Location Street Name	Area PD Response Areas
2026-00012324	Animal Call	03/05/2026 18:40	FM 1103	Cibolo (6)
2026-00013777	Animal Call	03/13/2026 23:23	COUNTRY LN	Cibolo (6)
2026-00013844	Animal Call	03/14/2026 15:24	EAGLE DR	Cibolo (6)
2026-00013100	Animal Call	03/10/2026 11:02	VALLEY OAK DR	Schertz (506)
2026-00014969	Animal Call	03/20/2026 10:15	CURTISS AVE	Schertz (401)
2026-00015771	Animal Call	03/24/2026 13:17	CHESTNUT DR	Schertz (401)
2026-00014882	Animal Call	03/19/2026 19:01	E FM 1518 N	Schertz (402)
2026-00012034	Animal Call	03/04/2026 10:26	TOLLE RD	Cibolo (5)
2026-00012071	Animal Call	03/04/2026 13:52	TOLLE RD	Cibolo (5)
2026-00013277	Animal Call	03/11/2026 10:56	SASSMAN RD	Cibolo (5)
2026-00013655	Animal Call	03/13/2026 10:51	N MAIN ST	Cibolo (5)
2026-00012672	Animal Call	03/07/2026 16:39	NICKEL BROOK	Cibolo (5)
2026-00014355	Animal Call	03/17/2026 08:53	GUADALUPE DR	Cibolo (5)
2026-00014951	Animal Call	03/20/2026 08:21	DOBIE BLVD	Cibolo (5)
2026-00017089	Animal Call	03/31/2026 13:41	CIBOLO VALLEY DR	Cibolo (5)
2026-00017054	Animal Call	03/31/2026 09:32	N MAIN ST	Cibolo (5)
2026-00016722	Animal Call	03/29/2026 16:20	CIBOLO DR	Cibolo (5)
2026-00017161	Animal Call	03/31/2026 20:50	CIBOLO VALLEY DR	Cibolo (5)
2026-00017107	Animal Call	03/31/2026 15:37	FM 1103	Cibolo (5)
2026-00015723	Animal Call	03/24/2026 08:26	CIBOLO DR	Cibolo (5)
2026-00015782	Animal Call	03/24/2026 14:00	SINGING BROOK	Cibolo (5)
2026-00015959	Animal Call	03/25/2026 12:14	SINGING BROOK	Cibolo (5)
2026-00012462	Animal Call	03/06/2026 14:43	HANA LN	Cibolo (5)
2026-00014767	Animal Call	03/19/2026 08:04	HIDDEN GROVE LN	Schertz (303)
2026-00012784	Animal Call	03/08/2026 07:45	PRAIRIE LN	Schertz (303)
2026-00012979	Animal Call	03/09/2026 15:33	BRUSH TRAIL BEND	Cibolo (3)
2026-00012709	Animal Call	03/07/2026 21:23	ARMOUR DR	Cibolo (3)
2026-00012472	Animal Call	03/06/2026 15:50	CARMEL DR	Cibolo (3)
2026-00012291	Animal Call	03/05/2026 14:42	BLAIN CIR	Cibolo (3)
2026-00012442	Animal Call	03/06/2026 13:10	GLEN EAGLES DR	Cibolo (3)
2026-00012304	Animal Call	03/05/2026 16:04	HIDDEN MESA	Cibolo (3)
2026-00016675	Animal Call	03/29/2026 09:38	CLOUD CROSSING	Cibolo (3)



Cibolo Police Department Report Call Summary

Results



Agency: CPD
Agency #: TX0940600

Print Date/Time: 04/01/2026 08:06
Total Records : 977

Incident Number	Incident Type	Call Date/Time	Location Street Name	Area PD Response Areas
2026-00013522	Animal Call	03/12/2026 16:39	SPICE OAK LN	Cibolo (3)
2026-00011449	Animal Call	03/01/2026 18:27	ZOELLER WAY	Cibolo (3)
2026-00011515	Animal Call	03/02/2026 07:52	DEER MEADOW BLVD	Cibolo (3)
2026-00016179	Animal Call	03/26/2026 12:01	RIO VISTA DR	Cibolo (3)
2026-00014626	Animal Call	03/18/2026 13:32	NOTCHLEAF	Cibolo (3)
2026-00016845	Animal Call	03/30/2026 11:55	SILVER WING	Cibolo (3)
2026-00011878	Animal Call	03/03/2026 16:05	HIDDEN CAVE	Cibolo (3)
2026-00014136	Animal Call	03/16/2026 08:32	FM 3009	Cibolo (3)
2026-00011839	Animal Call	03/03/2026 13:18	WOODSTONE LOOP	Cibolo (3)
2026-00012625	Animal Call	03/07/2026 09:35	IROLA DR	Schertz (201)
2026-00012078	Animal Call	03/04/2026 14:51	CHESTNUT OAK	Schertz (304)
2026-00012804	Animal Call	03/08/2026 13:04	ARROYO VERDE	Schertz (304)
2026-00017120	Animal Call	03/31/2026 16:29	WEIL RD	Cibolo (4)
2026-00011546	Animal Call	03/02/2026 10:54	HINGE FALLS	Cibolo (4)
2026-00015995	Animal Call	03/25/2026 15:37	STONEBROOK DR	Cibolo (4)
2026-00013327	Animal Call	03/11/2026 15:47	SADDLE HOUSE	Cibolo (4)
2026-00012867	Animal Call	03/08/2026 23:45	FM 1103	Cibolo (4)
2026-00014713	Animal Call	03/18/2026 23:30	FARMVIEW	Cibolo (4)
2026-00013520	Animal Call	03/12/2026 16:21	SADDLE DAWN	Cibolo (4)
2026-00014026	Animal Call	03/15/2026 16:00	HINGE CHASE	Cibolo (4)
2026-00016388	Animal Call	03/27/2026 11:34	CANYON VISTA	Cibolo (4)
2026-00014147	Animal Call	03/16/2026 09:11	WAGON WHEEL WAY	Cibolo (4)
2026-00016355	Animal Call	03/27/2026 08:21	SLIPPERY ROCK	Cibolo (4)
2026-00014174	Animal Call	03/16/2026 11:09	COWBOY PEAK	Cibolo (4)
2026-00016172	Animal Call	03/26/2026 11:27	SADDLE VISTA	Cibolo (4)
2026-00012259	Animal Call	03/05/2026 11:06	IH 35 N	Schertz (202)
2026-00014999	Animal Call	03/20/2026 13:01	IH 35 N	Cibolo (1)
2026-00013823	Animal Call	03/14/2026 12:40	IH 35 N	Cibolo (1)
2026-00012955	Animal Call	03/09/2026 12:48	BLUE WILLOW	Cibolo (1)
2026-00015566	Animal Call	03/23/2026 12:27	HARLEY HAY	Cibolo (1)
2026-00016415	Animal Call	03/27/2026 14:30	HANGING MOSS DR	Cibolo (1)
2026-00011780	Animal Call	03/03/2026 08:13	WEEPING WAY	Cibolo (1)
2026-00013259	Animal Call	03/11/2026 09:07	IH 35 N	Schertz (208)



Cibolo Police Department Report Call Summary Results



Agency: CPD
Agency #: TX0940600

Print Date/Time: 04/01/2026 08:06
Total Records : 977

Incident Number	Incident Type	Call Date/Time	Location Street Name	Area PD Response Areas
2026-00014430	Animal Call	03/17/2026 15:14	FM 1103	Cibolo (2)
2026-00014183	Animal Call	03/16/2026 12:00	TURNING STONE	Cibolo (2)
2026-00013309	Animal Call	03/11/2026 12:55	CORWIN SPGS	Cibolo (2)
2026-00013710	Animal Call	03/13/2026 16:09	RESACA	Cibolo (2)
2026-00013342	Animal Call	03/11/2026 17:43	WATERFORD	Cibolo (2)
2026-00012017	Animal Call	03/04/2026 09:21	AURORA BASIN	Cibolo (2)
2026-00011549	Animal Call	03/02/2026 11:23	RAMBLAS	Cibolo (2)
2026-00015746	Animal Call	03/24/2026 10:09	WIEDNER RD	Cibolo (2)
Incident Type: Animal Call-Barking Dog (13)				
2026-00014806	Animal Call-Barking Dog	03/19/2026 11:14	PINEY WOODS	Cibolo (6)
2026-00011779	Animal Call-Barking Dog	03/03/2026 08:10	MOONLIGHT CT	Cibolo (3)
2026-00016332	Animal Call-Barking Dog	03/27/2026 06:43	BRAESWOOD LN	Cibolo (3)
2026-00016411	Animal Call-Barking Dog	03/27/2026 14:13	BRAESWOOD LN	Cibolo (3)
2026-00015749	Animal Call-Barking Dog	03/24/2026 10:18	SILVER WING	Cibolo (3)
2026-00015757	Animal Call-Barking Dog	03/24/2026 11:07	SILVER WING	Cibolo (3)
2026-00015119	Animal Call-Barking Dog	03/20/2026 23:22	CORSICA DR	Cibolo (3)
2026-00011366	Animal Call-Barking Dog	03/01/2026 09:26	RUSTIC TRL	Cibolo (4)
2026-00016603	Animal Call-Barking Dog	03/28/2026 18:40	HEREFORD ST	Cibolo (4)
2026-00015321	Animal Call-Barking Dog	03/21/2026 23:51	HEAVENLY VW	Cibolo (4)
2026-00016645	Animal Call-Barking Dog	03/29/2026 01:26	TRANQUIL VW	Cibolo (4)
2026-00013903	Animal Call-Barking Dog	03/14/2026 22:48	GATEWOOD CLIFF	Cibolo (4)
2026-00016552	Animal Call-Barking Dog	03/28/2026 10:20	HEAVENLY VW	Cibolo (4)
Incident Type: Animal Call-Bite (7)				
2026-00013123	Animal Call-Bite	03/10/2026 13:25	COUNTRY LN	Cibolo (6)
2026-00012436	Animal Call-Bite	03/06/2026 12:32	DENISON DAM	Cibolo (6)
2026-00015769	Animal Call-Bite	03/24/2026 12:57	BROAD OAK DR	Cibolo (6)
2026-00011992	Animal Call-Bite	03/04/2026 07:59	IH 35 N	Schertz (201)
2026-00014394	Animal Call-Bite	03/17/2026 11:53	MOUNTAIN HOME	Cibolo (4)
2026-00015783	Animal Call-Bite	03/24/2026 14:02	HANGING MOSS DR	Cibolo (1)



Cibolo Police Department Report Call Summary

Results



Agency: CPD
Agency #: TX0940600

Print Date/Time: 04/01/2026 08:06
Total Records : 977

Incident Number	Incident Type	Call Date/Time	Location Street Name	Area PD Response Areas
2026-00013157	Animal Call-Bite	03/10/2026 17:01	FM 1103	Cibolo (2)
Incident Type: Animal Call-Follow Up (7)				
2026-00013486	Animal Call-Follow Up	03/12/2026 12:32	SHADY MEADOWS LN	Cibolo (6)
2026-00016423	Animal Call-Follow Up	03/27/2026 15:35	TOLLE RD	Cibolo (5)
2026-00013262	Animal Call-Follow Up	03/11/2026 09:38	WHITNEY WAY	Cibolo (3)
2026-00017062	Animal Call-Follow Up	03/31/2026 10:43	SCOTCH ROSE LN	Cibolo (3)
2026-00016827	Animal Call-Follow Up	03/30/2026 10:39	BENTWOOD RANCH DR	Cibolo (3)
2026-00013529	Animal Call-Follow Up	03/12/2026 17:08	SADDLE HOUSE	Cibolo (4)
2026-00013335	Animal Call-Follow Up	03/11/2026 16:38	SADDLE VISTA	Cibolo (4)
Incident Type: Assault-Already Occurred (6)				
2026-00014793	Assault-Already Occurred	03/19/2026 10:33	FM 1103	Cibolo (5)
2026-00016404	Assault-Already Occurred	03/27/2026 13:37	FM 1103	Cibolo (5)
2026-00012301	Assault-Already Occurred	03/05/2026 15:50	DEER MEADOW BLVD	Cibolo (3)
2026-00016387	Assault-Already Occurred	03/27/2026 11:31	W BORGFELD RD	Cibolo (3)
2026-00017165	Assault-Already Occurred	03/31/2026 21:02	HINGE LOOP	Cibolo (4)
2026-00012473	Assault-Already Occurred	03/06/2026 15:50	GREEN VALLEY RD	Cibolo (2)
Incident Type: Assist Ems (13)				
2026-00016519	Assist Ems	03/28/2026 03:20	LAMAR ST	Cibolo (5)
2026-00013485	Assist Ems	03/12/2026 12:23	W BORGFELD RD	Cibolo (5)
2026-00013336	Assist Ems	03/11/2026 16:44	S MAIN ST	Cibolo (5)
2026-00014056	Assist Ems	03/15/2026 21:47	GRAND AVE	Cibolo (3)
2026-00011314	Assist Ems	03/01/2026 06:20	OLYMPIC DR	Cibolo (3)
2026-00016954	Assist Ems	03/30/2026 21:15	DEW FALL TRL	Cibolo (3)
2026-00015425	Assist Ems	03/22/2026 20:14	SUNROSE LN	Cibolo (3)
2026-00013548	Assist Ems	03/12/2026 19:07	PROCTOR GROVE	Cibolo (4)
2026-00011329	Assist Ems	03/01/2026 07:25	FRITZ WAY	Cibolo (4)
2026-00014321	Assist Ems	03/17/2026 06:13	LIECK CV	Cibolo (4)
2026-00015813	Assist Ems	03/24/2026 16:06	BROOK STONE	Cibolo (1)
2026-00011364	Assist Ems	03/01/2026 09:24	ASIAGO	Cibolo (2)



Cibolo Police Department Report Call Summary Results



Agency: CPD
Agency #: TX0940600

Print Date/Time: 04/01/2026 08:06
Total Records : 977

Incident Number	Incident Type	Call Date/Time	Location Street Name	Area PD Response Areas
2026-00016117	Assist Ems	03/26/2026 07:12	WATERFORD	Cibolo (2)
Incident Type: Assist Fire (Non-Structure) (2)				
2026-00016447	Assist Fire (Non-Structure)	03/27/2026 18:29	FM 1103	Cibolo (5)
2026-00014832	Assist Fire (Non-Structure)	03/19/2026 15:18	GARDNER CV	Cibolo (4)
Incident Type: Assist Fire- Structure Fire (2)				
2026-00014043	Assist Fire-Structure Fire	03/15/2026 19:48	BELLA ROSA WAY	Cibolo (3)
2026-00014864	Assist Fire-Structure Fire	03/19/2026 17:16	SADDLE BACK TRL	Cibolo (4)
Incident Type: Assist Other Agency (29)				
2026-00016472	Assist Other Agency	03/27/2026 20:55	SAMBAR MAIN	Cibolo (6)
2026-00016492	Assist Other Agency	03/27/2026 22:40	SAMBAR MAIN	Cibolo (6)
2026-00015369	Assist Other Agency	03/22/2026 08:46	HAECKERVILLE RD	Cibolo (6)
2026-00014410	Assist Other Agency	03/17/2026 13:32	FALCON DR	Cibolo (6)
2026-00013578	Assist Other Agency	03/12/2026 22:51	FM 78 W	Cibolo (6)
2026-00013974	Assist Other Agency	03/15/2026 10:02	BORGFELD RD	Schertz (301)
2026-00016537	Assist Other Agency	03/28/2026 08:14	BORGFELD RD	Schertz (301)
2026-00012581	Assist Other Agency	03/07/2026 00:49	LAURAN PARK DR	Schertz (301)
2026-00011953	Assist Other Agency	03/04/2026 00:56	ELBEL RD	Schertz (302)
2026-00016649	Assist Other Agency	03/29/2026 02:04	TOLLE RD	Cibolo (5)
2026-00016741	Assist Other Agency	03/29/2026 20:03	TOLLE RD	Cibolo (5)
2026-00015863	Assist Other Agency	03/24/2026 23:32	S MAIN ST	Cibolo (5)
2026-00013408	Assist Other Agency	03/12/2026 01:19	FM 1103	Cibolo (5)
2026-00016016	Assist Other Agency	03/25/2026 17:45	CIBOLO VALLEY DR	Cibolo (5)
2026-00016775	Assist Other Agency	03/30/2026 02:42	FIREBIRD RUN	Cibolo (3)
2026-00014436	Assist Other Agency	03/17/2026 15:29	TURKEY TREE	Cibolo (3)
2026-00015337	Assist Other Agency	03/22/2026 01:13	W BORGFELD RD	Cibolo (3)
2026-00015257	Assist Other Agency	03/21/2026 16:14	HINGE PATH	Cibolo (4)



Cibolo Police Department Report Call Summary Results



Agency: CPD
Agency #: TX0940600

Print Date/Time: 04/01/2026 08:06
Total Records : 977

Incident Number	Incident Type	Call Date/Time	Location Street Name	Area PD Response Areas
2026-00012568	Assist Other Agency	03/07/2026 00:12	PRICKLY PEAR DR	Cibolo (4)
2026-00011417	Assist Other Agency	03/01/2026 14:19	NIEMIETZ CV	Cibolo (4)
2026-00011957	Assist Other Agency	03/04/2026 01:18	CORRAL FENCE	Cibolo (4)
2026-00011885	Assist Other Agency	03/03/2026 16:32	SPRINGTREE CV	Cibolo (1)
2026-00013534	Assist Other Agency	03/12/2026 17:44	CIBOLO VALLEY DR	Cibolo (1)
2026-00014461	Assist Other Agency	03/17/2026 17:12	CIBOLO VALLEY DR	Cibolo (1)
2026-00017178	Assist Other Agency	03/31/2026 22:59	LOOKOUT RD	Schertz (203)
2026-00016746	Assist Other Agency	03/29/2026 20:54	FM 1103	Cibolo (2)
2026-00014874	Assist Other Agency	03/19/2026 18:11	CHELSEA DR	Cibolo (2)
2026-00012236	Assist Other Agency	03/05/2026 08:44	BEE CAVES CV	Cibolo (2)
2026-00013786	Assist Other Agency	03/14/2026 00:29	CLEARBROOK AVE	Schertz (101)
Incident Type: Assist Public (12)				
2026-00012096	Assist Public	03/04/2026 16:18	LOOP 539 E	Cibolo (5)
2026-00016430	Assist Public	03/27/2026 16:14	LOOP 539 E	Cibolo (5)
2026-00016919	Assist Public	03/30/2026 17:47	LOOP 539 E	Cibolo (5)
2026-00011610	Assist Public	03/02/2026 18:13	W BORGFELD RD	Cibolo (5)
2026-00016015	Assist Public	03/25/2026 17:37	W BORGFELD RD	Cibolo (5)
2026-00016846	Assist Public	03/30/2026 12:05	EVERYDAY WAY	Cibolo (5)
2026-00013855	Assist Public	03/14/2026 16:15	CIBOLO VALLEY DR	Cibolo (5)
2026-00012358	Assist Public	03/05/2026 23:49	TOLLE RD	Cibolo (5)
2026-00012146	Assist Public	03/04/2026 21:07	CIBOLO VALLEY DR	Cibolo (3)
2026-00012812	Assist Public	03/08/2026 15:21	GARDNER CV	Cibolo (4)
2026-00013080	Assist Public	03/10/2026 08:53	CIBOLO VALLEY DR	Cibolo (1)
2026-00012241	Assist Public	03/05/2026 09:04	N WILLOW WAY	Cibolo (1)
Incident Type: Burglary (2)				
2026-00013264	Burglary	03/11/2026 09:42	SHADY MEADOWS LN	Cibolo (6)
2026-00011480	Burglary	03/01/2026 23:45	CIBOLO COMMONS	Cibolo (4)



Cibolo Police Department Report Call Summary Results



Agency: CPD
Agency #: TX0940600

Print Date/Time: 04/01/2026 08:06
Total Records : 977

Incident Number	Incident Type	Call Date/Time	Location Street Name	Area PD Response Areas
Incident Type: Burglary Vehicle (2)				
2026-00014243	Burglary Vehicle	03/16/2026 18:44	BRUSH TRAIL BEND	Cibolo (3)
2026-00015697	Burglary Vehicle	03/24/2026 06:11	MORGAN RUN	Cibolo (4)
Incident Type: City Code Violation (23)				
2026-00016704	City Code Violation	03/29/2026 12:56	CONCORDIA LN	Cibolo (6)
2026-00014128	City Code Violation	03/16/2026 08:12	HAECKERVILLE RD	Cibolo (6)
2026-00016885	City Code Violation	03/30/2026 14:46	MOOSE TRL	Cibolo (6)
2026-00015264	City Code Violation	03/21/2026 17:10	COUNTRY LN	Cibolo (5)
2026-00015248	City Code Violation	03/21/2026 15:04	EVERYDAY WAY	Cibolo (5)
2026-00013119	City Code Violation	03/10/2026 12:33	FM 1103	Cibolo (5)
2026-00013160	City Code Violation	03/10/2026 17:07	FM 1103	Cibolo (5)
2026-00014023	City Code Violation	03/15/2026 15:50	CIBOLO VALLEY DR	Cibolo (5)
2026-00013161	City Code Violation	03/10/2026 17:10	BELLA ROSA TRL	Cibolo (3)
2026-00016169	City Code Violation	03/26/2026 10:54	HIDDEN CAVE	Cibolo (3)
2026-00014206	City Code Violation	03/16/2026 15:23	VALONA DR	Cibolo (3)
2026-00011869	City Code Violation	03/03/2026 15:09	DEER MEADOW BLVD	Cibolo (3)
2026-00016560	City Code Violation	03/28/2026 11:17	LIECK CV	Cibolo (4)
2026-00011431	City Code Violation	03/01/2026 16:01	LONGHORN WAY	Cibolo (4)
2026-00016261	City Code Violation	03/26/2026 19:22	CATTLE RUN	Cibolo (4)
2026-00011920	City Code Violation	03/03/2026 20:57	NORWOOD CT	Cibolo (4)
2026-00016594	City Code Violation	03/28/2026 17:09	HINGE FALLS	Cibolo (4)
2026-00014153	City Code Violation	03/16/2026 09:40	CATTLE RUN	Cibolo (4)
2026-00016559	City Code Violation	03/28/2026 11:14	SPRINGTREE GROVE	Cibolo (1)
2026-00014060	City Code Violation	03/15/2026 22:15	STRESA	Cibolo (2)
2026-00014677	City Code Violation	03/18/2026 17:23	STRESA	Cibolo (2)
2026-00016556	City Code Violation	03/28/2026 10:30	STRESA	Cibolo (2)



Cibolo Police Department Report Call Summary Results



Agency: CPD
Agency #: TX0940600

Print Date/Time: 04/01/2026 08:06
Total Records : 977

Incident Number	Incident Type	Call Date/Time	Location Street Name	Area PD Response Areas
2026-00015841	City Code Violation	03/24/2026 20:02	TIRESTE	Cibolo (2)
Incident Type: City Code Violation-Solicitor (1)				
2026-00012098	City Code Violation-Solicitor	03/04/2026 16:19	LOWER SEGUIN RD	Cibolo (6)
Incident Type: Civil Matter/Standby (40)				
2026-00012671	Civil Matter/Standby	03/07/2026 16:29	BROAD OAK DR	Cibolo (6)
2026-00015432	Civil Matter/Standby	03/22/2026 22:08	COUNTRY LN	Cibolo (6)
2026-00014870	Civil Matter/Standby	03/19/2026 17:54	IH 10 W	Cibolo (6)
2026-00012673	Civil Matter/Standby	03/07/2026 16:56	SHADY MEADOWS LN	Cibolo (6)
2026-00014489	Civil Matter/Standby	03/17/2026 20:45	FM 1103	Cibolo (5)
2026-00014872	Civil Matter/Standby	03/19/2026 18:03	LOOP 539 E	Cibolo (5)
2026-00016737	Civil Matter/Standby	03/29/2026 19:11	RUSHING BANKS	Cibolo (5)
2026-00016935	Civil Matter/Standby	03/30/2026 19:32	RUSHING BANKS	Cibolo (5)
2026-00015506	Civil Matter/Standby	03/23/2026 07:33	PORTRUSH LN	Cibolo (3)
2026-00015272	Civil Matter/Standby	03/21/2026 19:08	GLEN EAGLES DR	Cibolo (3)
2026-00014139	Civil Matter/Standby	03/16/2026 08:45	FALCON CROSSING	Cibolo (3)
2026-00015216	Civil Matter/Standby	03/21/2026 10:56	FALCON CROSSING	Cibolo (3)
2026-00014044	Civil Matter/Standby	03/15/2026 19:52	SADDLE VISTA	Cibolo (4)
2026-00016906	Civil Matter/Standby	03/30/2026 16:24	CLYDESDALE ST	Cibolo (4)
2026-00016917	Civil Matter/Standby	03/30/2026 17:30	CLYDESDALE ST	Cibolo (4)
2026-00011612	Civil Matter/Standby	03/02/2026 18:26	GARDNER CV	Cibolo (4)
2026-00015443	Civil Matter/Standby	03/22/2026 22:42	WIEDNER RD	Cibolo (4)
2026-00012664	Civil Matter/Standby	03/07/2026 15:27	HINGE CHASE	Cibolo (4)
2026-00012814	Civil Matter/Standby	03/08/2026 15:52	SADDLE SPOKE	Cibolo (4)
2026-00012952	Civil Matter/Standby	03/09/2026 12:32	BUCKBOARD LN	Cibolo (4)
2026-00013887	Civil Matter/Standby	03/14/2026 20:34	BUCKSKIN WAY	Cibolo (4)



Cibolo Police Department Report Call Summary Results



Agency: CPD
Agency #: TX0940600

Print Date/Time: 04/01/2026 08:06
Total Records : 977

Incident Number	Incident Type	Call Date/Time	Location Street Name	Area PD Response Areas
2026-00013740	Civil Matter/Standby	03/13/2026 19:38	HINGE LOOP	Cibolo (4)
2026-00016733	Civil Matter/Standby	03/29/2026 18:19	GOLDEN VISTA	Cibolo (4)
2026-00012234	Civil Matter/Standby	03/05/2026 08:36	CIBOLO COMMONS	Cibolo (4)
2026-00014795	Civil Matter/Standby	03/19/2026 10:34	SLIPPERY ROCK	Cibolo (4)
2026-00014883	Civil Matter/Standby	03/19/2026 19:10	SLIPPERY ROCK	Cibolo (4)
2026-00015585	Civil Matter/Standby	03/23/2026 14:23	SCENIC VISTA	Cibolo (4)
2026-00012421	Civil Matter/Standby	03/06/2026 10:48	WILLOW RUN	Cibolo (1)
2026-00012790	Civil Matter/Standby	03/08/2026 08:36	WILLOW RUN	Cibolo (1)
2026-00014820	Civil Matter/Standby	03/19/2026 14:00	N WILLOW WAY	Cibolo (1)
2026-00014972	Civil Matter/Standby	03/20/2026 10:48	N WILLOW WAY	Cibolo (1)
2026-00015571	Civil Matter/Standby	03/23/2026 12:52	PLUM CIR	Cibolo (1)
2026-00015812	Civil Matter/Standby	03/24/2026 16:05	BROOK STONE	Cibolo (1)
2026-00015982	Civil Matter/Standby	03/25/2026 14:45	BROOK STONE	Cibolo (1)
2026-00016407	Civil Matter/Standby	03/27/2026 13:51	BROOK STONE	Cibolo (1)
2026-00017090	Civil Matter/Standby	03/31/2026 14:06	BROOK STONE	Cibolo (1)
2026-00016545	Civil Matter/Standby	03/28/2026 08:54	BROOK VW	Cibolo (1)
2026-00014409	Civil Matter/Standby	03/17/2026 13:27	WEXFORD	Cibolo (2)
2026-00013494	Civil Matter/Standby	03/12/2026 13:50	SAN ROGUE	Cibolo (2)
2026-00014246	Civil Matter/Standby	03/16/2026 19:00	LANDMARK GATE	Cibolo (2)
Incident Type: CPS Follow Up (1)				
2026-00014521	CPS Follow Up	03/18/2026 03:03	LOOP 539 E	Cibolo (5)
Incident Type: Cps Referral (5)				
2026-00012048	Cps Referral	03/04/2026 11:02	FM 1103	Cibolo (5)
2026-00012280	Cps Referral	03/05/2026 13:41	DEER MEADOW BLVD	Cibolo (3)
2026-00016836	Cps Referral	03/30/2026 11:22	HANOVER PLACE	Cibolo (4)
2026-00016219	Cps Referral	03/26/2026 15:35	GREEN VALLEY RD	Cibolo (2)



Cibolo Police Department Report Call Summary Results



Agency: CPD
Agency #: TX0940600

Print Date/Time: 04/01/2026 08:06
Total Records : 977

Incident Number	Incident Type	Call Date/Time	Location Street Name	Area PD Response Areas
2026-00016218	Cps Referral	03/26/2026 15:33	GREEN VALLEY RD	Cibolo (2)
Incident Type: Criminal Mischief (3)				
2026-00012802	Criminal Mischief	03/08/2026 12:34	TWISTING STREAM	Cibolo (5)
2026-00014322	Criminal Mischief	03/17/2026 06:33	CIBOLO TOLLE RD	Cibolo (5)
2026-00016136	Criminal Mischief	03/26/2026 08:23	LONE STAR WAY	Cibolo (4)
Incident Type: Damage To Property (5)				
2026-00016149	Damage To Property	03/26/2026 09:18	TOLLE RD	Cibolo (5)
2026-00014636	Damage To Property	03/18/2026 14:28	FM 1103	Cibolo (5)
2026-00014034	Damage To Property	03/15/2026 18:37	TURKEY TREE	Cibolo (3)
2026-00016856	Damage To Property	03/30/2026 12:42	BRUSH TRAIL BEND	Cibolo (3)
2026-00012999	Damage To Property	03/09/2026 17:41	FM 3009	Cibolo (3)
Incident Type: Deceased Party (6)				
2026-00015466	Deceased Party	03/23/2026 01:28	PUDU TRL	Cibolo (6)
2026-00011419	Deceased Party	03/01/2026 14:55	EVERYDAY WAY	Cibolo (5)
2026-00013816	Deceased Party	03/14/2026 11:04	CORDERO DR	Cibolo (3)
2026-00016945	Deceased Party	03/30/2026 20:23	LOCH LOMOND DR	Cibolo (3)
2026-00014621	Deceased Party	03/18/2026 13:21	CACTUS FLOWER	Cibolo (4)
2026-00014749	Deceased Party	03/19/2026 05:06	SPRINGTREE PKWY	Cibolo (1)
Incident Type: Disabled Vehicle (21)				
2026-00011307	Disabled Vehicle	03/01/2026 02:58	IH 10 W	Cibolo (6)
2026-00013352	Disabled Vehicle	03/11/2026 18:54	FM 1103	Cibolo (6)
2026-00014994	Disabled Vehicle	03/20/2026 12:36	FM 1103	Cibolo (6)
2026-00014368	Disabled Vehicle	03/17/2026 09:29	FM 78 E	Cibolo (6)
2026-00012624	Disabled Vehicle	03/07/2026 09:31	IH 10 W	Cibolo (6)
2026-00016862	Disabled Vehicle	03/30/2026 13:08	FM 78 W	Cibolo (5)
2026-00012160	Disabled Vehicle	03/04/2026 21:52	FM 78 E	Cibolo (5)
2026-00012956	Disabled Vehicle	03/09/2026 13:05	MOHAWK DR	Cibolo (5)
2026-00016803	Disabled Vehicle	03/30/2026 08:10	COUNTRY LN	Cibolo (5)
2026-00012619	Disabled Vehicle	03/07/2026 09:09	FM 1103	Cibolo (5)
2026-00013687	Disabled Vehicle	03/13/2026 14:27	FM 78 E	Cibolo (5)



Cibolo Police Department Report Call Summary Results



Agency: CPD
Agency #: TX0940600

Print Date/Time: 04/01/2026 08:06
Total Records : 977

Incident Number	Incident Type	Call Date/Time	Location Street Name	Area PD Response Areas
2026-00015260	Disabled Vehicle	03/21/2026 17:06	FM 78 E	Cibolo (5)
2026-00014212	Disabled Vehicle	03/16/2026 15:50	FM 1103	Cibolo (5)
2026-00013321	Disabled Vehicle	03/11/2026 14:27	LANCE CROSSING	Cibolo (5)
2026-00015209	Disabled Vehicle	03/21/2026 09:31	CIBOLO VALLEY DR	Cibolo (3)
2026-00017098	Disabled Vehicle	03/31/2026 14:39	WEIL RD	Cibolo (4)
2026-00014172	Disabled Vehicle	03/16/2026 11:04	TOLLE RD	Cibolo (4)
2026-00012302	Disabled Vehicle	03/05/2026 15:51	FM 1103	Cibolo (4)
2026-00014853	Disabled Vehicle	03/19/2026 16:37	RIPPS-KREUSLER	Cibolo (1)
2026-00015030	Disabled Vehicle	03/20/2026 15:54	CIBOLO VALLEY DR	Schertz (208)
2026-00015676	Disabled Vehicle	03/24/2026 00:38	FM 78 W	Guadalupe County
Incident Type: Dist - Noise (14)				
2026-00015138	Dist - Noise	03/21/2026 00:41	FALCON DR	Cibolo (6)
2026-00013890	Dist - Noise	03/14/2026 21:01	FM 78 W	Cibolo (5)
2026-00016625	Dist - Noise	03/28/2026 22:27	JACQUELINE ST	Cibolo (5)
2026-00016628	Dist - Noise	03/28/2026 22:49	JACQUELINE ST	Cibolo (5)
2026-00012349	Dist - Noise	03/05/2026 22:33	N MAIN ST	Cibolo (5)
2026-00014485	Dist - Noise	03/17/2026 20:16	N MAIN ST	Cibolo (5)
2026-00016638	Dist - Noise	03/29/2026 00:17	EVERYDAY WAY	Cibolo (5)
2026-00016666	Dist - Noise	03/29/2026 08:30	SEA HEADRIG DR	Cibolo (3)
2026-00016648	Dist - Noise	03/29/2026 02:06	ROYAL TROON DR	Cibolo (3)
2026-00016738	Dist - Noise	03/29/2026 19:24	CIBOLO COMMONS	Cibolo (4)
2026-00016747	Dist - Noise	03/29/2026 20:56	CIBOLO COMMONS	Cibolo (4)
2026-00015661	Dist - Noise	03/23/2026 21:30	BEE CAVES CV	Cibolo (2)
2026-00014498	Dist - Noise	03/17/2026 22:21	FM 1103	Cibolo (2)
2026-00013981	Dist - Noise	03/15/2026 10:39	HAECKERVILLE RD	Guadalupe County
Incident Type: Disturbance-Non Viol (20)				
2026-00013478	Disturbance-Non Viol	03/12/2026 11:35	BROAD OAK DR	Cibolo (6)
2026-00013561	Disturbance-Non Viol	03/12/2026 20:16	BROAD OAK DR	Cibolo (6)
2026-00016463	Disturbance-Non Viol	03/27/2026 20:06	FM 78 W	Cibolo (6)



Cibolo Police Department Report Call Summary Results



Agency: CPD
Agency #: TX0940600

Print Date/Time: 04/01/2026 08:06
Total Records : 977

Incident Number	Incident Type	Call Date/Time	Location Street Name	Area PD Response Areas
2026-00012772	Disturbance-Non Viol	03/08/2026 03:44	BROAD OAK DR	Cibolo (6)
2026-00013879	Disturbance-Non Viol	03/14/2026 19:56	COUNTRY LN	Cibolo (6)
2026-00011598	Disturbance-Non Viol	03/02/2026 16:53	TWISTING STREAM	Cibolo (5)
2026-00013851	Disturbance-Non Viol	03/14/2026 15:53	LILAC SHOALS	Cibolo (5)
2026-00014611	Disturbance-Non Viol	03/18/2026 12:19	SIOUX CIR	Cibolo (5)
2026-00016397	Disturbance-Non Viol	03/27/2026 12:36	FM 1103	Cibolo (5)
2026-00013181	Disturbance-Non Viol	03/10/2026 19:41	FM 1103	Cibolo (5)
2026-00017133	Disturbance-Non Viol	03/31/2026 17:43	FM 1103	Cibolo (5)
2026-00011559	Disturbance-Non Viol	03/02/2026 12:21	HANA LN	Cibolo (5)
2026-00016900	Disturbance-Non Viol	03/30/2026 15:34	SCOTCH ROSE LN	Cibolo (3)
2026-00015634	Disturbance-Non Viol	03/23/2026 18:21	CORRAL FENCE	Cibolo (4)
2026-00015390	Disturbance-Non Viol	03/22/2026 12:10	STONEBROOK DR	Cibolo (4)
2026-00014686	Disturbance-Non Viol	03/18/2026 20:01	OTIS CROSSING	Cibolo (4)
2026-00016050	Disturbance-Non Viol	03/25/2026 22:09	IH 35 N	Cibolo (1)
2026-00016703	Disturbance-Non Viol	03/29/2026 12:51	BOULDER VW	Cibolo (1)
2026-00016195	Disturbance-Non Viol	03/26/2026 13:33	SPRINGTREE LN	Cibolo (1)
2026-00016010	Disturbance-Non Viol	03/25/2026 17:14	LANDMARK POND	Cibolo (2)
Incident Type: Disturbance-Violent (13)				
2026-00013418	Disturbance-Violent	03/12/2026 02:27	FM 78 W	Cibolo (6)
2026-00011954	Disturbance-Violent	03/04/2026 00:58	AERO AVE	Schertz (401)
2026-00015281	Disturbance-Violent	03/21/2026 20:02	EVERYDAY WAY	Cibolo (5)
2026-00016228	Disturbance-Violent	03/26/2026 16:15	DOBIE BLVD	Cibolo (5)
2026-00016035	Disturbance-Violent	03/25/2026 19:54	FM 1103	Cibolo (5)
2026-00012139	Disturbance-Violent	03/04/2026 20:33	APACHE CIR	Cibolo (5)
2026-00016994	Disturbance-Violent	03/31/2026 00:39	FM 1103	Cibolo (5)



Cibolo Police Department Report Call Summary Results



Agency: CPD
Agency #: TX0940600

Print Date/Time: 04/01/2026 08:06
Total Records : 977

Incident Number	Incident Type	Call Date/Time	Location Street Name	Area PD Response Areas
2026-00017176	Disturbance-Violent	03/31/2026 22:46	FIREBIRD RUN	Cibolo (3)
2026-00016951	Disturbance-Violent	03/30/2026 21:07	OAKMONT WAY	Cibolo (3)
2026-00012794	Disturbance-Violent	03/08/2026 09:17	BUCKBOARD LN	Cibolo (4)
2026-00013788	Disturbance-Violent	03/14/2026 01:34	HINGE PATH	Cibolo (4)
2026-00014492	Disturbance-Violent	03/17/2026 21:03	SLIPPERY ROCK	Cibolo (4)
2026-00015829	Disturbance-Violent	03/24/2026 18:27	WILLOW BLF	Cibolo (1)
Incident Type: Drug Offense (12)				
2026-00011584	Drug Offense	03/02/2026 15:08	FM 1103	Cibolo (5)
2026-00012245	Drug Offense	03/05/2026 09:21	FM 1103	Cibolo (5)
2026-00015751	Drug Offense	03/24/2026 10:30	FM 1103	Cibolo (5)
2026-00015792	Drug Offense	03/24/2026 14:54	FM 1103	Cibolo (5)
2026-00015974	Drug Offense	03/25/2026 14:10	FM 1103	Cibolo (5)
2026-00015987	Drug Offense	03/25/2026 15:07	FM 1103	Cibolo (5)
2026-00016370	Drug Offense	03/27/2026 09:58	FM 1103	Cibolo (5)
2026-00016371	Drug Offense	03/27/2026 09:58	FM 1103	Cibolo (5)
2026-00011860	Drug Offense	03/03/2026 14:29	W BORGFELD RD	Cibolo (3)
2026-00014998	Drug Offense	03/20/2026 12:56	W BORGFELD RD	Cibolo (3)
2026-00016734	Drug Offense	03/29/2026 18:32	NOMAD LN	Cibolo (4)
2026-00012561	Drug Offense	03/06/2026 23:44	KINGS WAY	Cibolo (1)
Incident Type: Flock Alert (4)				
2026-00015624	Flock Alert	03/23/2026 17:10	S MAIN ST	Cibolo (5)
2026-00012288	Flock Alert	03/05/2026 14:19	OLD WIEDERSTEIN RD	Cibolo (1)
2026-00012094	Flock Alert	03/04/2026 16:08	GREEN VALLEY RD	Cibolo (2)
2026-00015424	Flock Alert	03/22/2026 20:01	IH 35 N	Schertz (207)
Incident Type: Follow Up (66)				
2026-00016850	Follow Up	03/30/2026 12:08	AXIS VALLEY	Cibolo (6)
2026-00016865	Follow Up	03/30/2026 13:19	AXIS VALLEY	Cibolo (6)
2026-00016895	Follow Up	03/30/2026 15:31	AXIS VALLEY	Cibolo (6)
2026-00016500	Follow Up	03/27/2026 23:43	BROAD OAK DR	Cibolo (6)
2026-00014582	Follow Up	03/18/2026 10:03	FM 78 W	Cibolo (6)
2026-00016039	Follow Up	03/25/2026 20:38	BROAD OAK DR	Cibolo (6)



Cibolo Police Department Report Call Summary

Results



Agency: CPD
Agency #: TX0940600

Print Date/Time: 04/01/2026 08:06
Total Records : 977

Incident Number	Incident Type	Call Date/Time	Location Street Name	Area PD Response Areas
2026-00015052	Follow Up	03/20/2026 19:58	COUNTRY LN	Cibolo (6)
2026-00013745	Follow Up	03/13/2026 19:54	LAURAN PARK DR	Schertz (301)
2026-00012097	Follow Up	03/04/2026 16:14	SCHERTZ PKWY	Schertz (302)
2026-00012043	Follow Up	03/04/2026 10:43	BRAMBLEWOOD CIR	Cibolo (5)
2026-00011642	Follow Up	03/02/2026 21:21	CIBOLO VALLEY DR	Cibolo (5)
2026-00015306	Follow Up	03/21/2026 22:18	CIBOLO VALLEY DR	Cibolo (5)
2026-00014596	Follow Up	03/18/2026 11:00	FM 1103	Cibolo (5)
2026-00012820	Follow Up	03/08/2026 17:26	TWISTING STREAM	Cibolo (5)
2026-00012926	Follow Up	03/09/2026 09:33	MOHAWK DR	Cibolo (5)
2026-00012989	Follow Up	03/09/2026 16:02	N MAIN ST	Cibolo (5)
2026-00014417	Follow Up	03/17/2026 13:59	CIBOLO VALLEY DR	Cibolo (5)
2026-00012425	Follow Up	03/06/2026 11:04	FM 1103	Cibolo (5)
2026-00014162	Follow Up	03/16/2026 10:23	FM 1103	Cibolo (5)
2026-00011442	Follow Up	03/01/2026 17:25	LOOP 539 E	Cibolo (5)
2026-00012027	Follow Up	03/04/2026 10:03	LOOP 539 E	Cibolo (5)
2026-00012281	Follow Up	03/05/2026 13:44	LOOP 539 E	Cibolo (5)
2026-00012508	Follow Up	03/06/2026 19:12	LOOP 539 E	Cibolo (5)
2026-00012512	Follow Up	03/06/2026 19:34	LOOP 539 E	Cibolo (5)
2026-00012656	Follow Up	03/07/2026 14:27	LOOP 539 E	Cibolo (5)
2026-00013127	Follow Up	03/10/2026 14:09	LOOP 539 E	Cibolo (5)
2026-00013992	Follow Up	03/15/2026 11:18	LOOP 539 E	Cibolo (5)
2026-00015280	Follow Up	03/21/2026 19:57	LOOP 539 E	Cibolo (5)
2026-00015554	Follow Up	03/23/2026 10:53	LOOP 539 E	Cibolo (5)
2026-00016290	Follow Up	03/26/2026 22:14	LOOP 539 E	Cibolo (5)
2026-00011397	Follow Up	03/01/2026 12:20	CIBOLO VALLEY DR	Cibolo (5)
2026-00012429	Follow Up	03/06/2026 11:23	CIBOLO VALLEY DR	Cibolo (5)
2026-00014788	Follow Up	03/19/2026 09:58	CIBOLO VALLEY DR	Cibolo (5)
2026-00015657	Follow Up	03/23/2026 21:01	FM 1103	Cibolo (5)
2026-00016241	Follow Up	03/26/2026 17:24	COUNTRY LN	Cibolo (5)
2026-00014354	Follow Up	03/17/2026 08:50	CIBOLO TOLLE RD	Cibolo (5)
2026-00013858	Follow Up	03/14/2026 16:33	LOOP 539 E	Cibolo (5)



Cibolo Police Department Report Call Summary Results



Agency: CPD
Agency #: TX0940600

Print Date/Time: 04/01/2026 08:06
Total Records : 977

Incident Number	Incident Type	Call Date/Time	Location Street Name	Area PD Response Areas
2026-00015668	Follow Up	03/23/2026 23:17	SCOTCH ROSE LN	Cibolo (3)
2026-00015242	Follow Up	03/21/2026 14:37	HILTON DR	Cibolo (3)
2026-00014774	Follow Up	03/19/2026 08:43	TURKEY TREE	Cibolo (3)
2026-00013714	Follow Up	03/13/2026 16:20	NOTCHLEAF	Cibolo (3)
2026-00016867	Follow Up	03/30/2026 13:18	HAZELTINE WAY	Cibolo (3)
2026-00012270	Follow Up	03/05/2026 12:31	W BORGFELD RD	Cibolo (3)
2026-00011985	Follow Up	03/04/2026 07:31	THISTLE CREEK DR	Cibolo (3)
2026-00012483	Follow Up	03/06/2026 17:03	THISTLE CREEK DR	Cibolo (3)
2026-00013911	Follow Up	03/14/2026 23:30	FM 1103	Cibolo (4)
2026-00014025	Follow Up	03/15/2026 15:57	STONEBROOK DR	Cibolo (4)
2026-00015832	Follow Up	03/24/2026 18:40	FM 1103	Cibolo (4)
2026-00011550	Follow Up	03/02/2026 11:26	GATEWOOD BRIAR	Cibolo (4)
2026-00015259	Follow Up	03/21/2026 16:51	LONGHORN WAY	Cibolo (4)
2026-00014808	Follow Up	03/19/2026 11:27	PRAIRIE VISTA	Cibolo (4)
2026-00011581	Follow Up	03/02/2026 14:53	NIEMIETZ CV	Cibolo (4)
2026-00012029	Follow Up	03/04/2026 10:21	NIEMIETZ CV	Cibolo (4)
2026-00017126	Follow Up	03/31/2026 16:58	CIBOLO COMMONS	Cibolo (4)
2026-00014613	Follow Up	03/18/2026 12:31	SLIPPERY ROCK	Cibolo (4)
2026-00016725	Follow Up	03/29/2026 17:05	HINGE FALLS	Cibolo (4)
2026-00015418	Follow Up	03/22/2026 18:58	SLIPPERY ROCK	Cibolo (4)
2026-00015994	Follow Up	03/25/2026 15:27	SWIFT MOVE	Cibolo (1)
2026-00014894	Follow Up	03/19/2026 21:06	BLUE WILLOW	Cibolo (1)
2026-00016209	Follow Up	03/26/2026 14:42	IH 35 N	Cibolo (1)
2026-00011557	Follow Up	03/02/2026 12:11	WILLOW RUN	Cibolo (1)
2026-00012682	Follow Up	03/07/2026 18:00	WILLOW RUN	Cibolo (1)
2026-00014457	Follow Up	03/17/2026 17:05	BROOK SHADOW	Cibolo (1)
2026-00016691	Follow Up	03/29/2026 11:19	CALIBAN	Cibolo (2)
2026-00016107	Follow Up	03/26/2026 06:26	LANDMARK PASS	Cibolo (2)
2026-00013512	Follow Up	03/12/2026 15:05	PADOVA	Cibolo (2)
Incident Type: Follow Up-Online Report (26)				
2026-00012711	Follow Up-Online Report	03/07/2026 21:54	RED RIVER	Cibolo (6)



Cibolo Police Department Report Call Summary

Results



Agency: CPD
Agency #: TX0940600

Print Date/Time: 04/01/2026 08:06
Total Records : 977

Incident Number	Incident Type	Call Date/Time	Location Street Name	Area PD Response Areas
2026-00015311	Follow Up-Online Report	03/21/2026 23:13	TOWN FORK	Cibolo (6)
2026-00016583	Follow Up-Online Report	03/28/2026 16:20	PINEY WOODS	Cibolo (6)
2026-00015073	Follow Up-Online Report	03/20/2026 21:05	MOOSE TRL	Cibolo (6)
2026-00014780	Follow Up-Online Report	03/19/2026 09:38	STEELE SHALLOWS	Cibolo (5)
2026-00014947	Follow Up-Online Report	03/20/2026 08:11	SIOUX CIR	Cibolo (5)
2026-00012028	Follow Up-Online Report	03/04/2026 10:11	LOOP 539 E	Cibolo (5)
2026-00013952	Follow Up-Online Report	03/15/2026 08:19	CINNABAR TRL	Cibolo (3)
2026-00011305	Follow Up-Online Report	03/01/2026 02:35	SILVER WING	Cibolo (3)
2026-00011822	Follow Up-Online Report	03/03/2026 11:34	AUTUMN FALL	Cibolo (3)
2026-00015781	Follow Up-Online Report	03/24/2026 13:58	BRUSH TRAIL BEND	Cibolo (3)
2026-00015645	Follow Up-Online Report	03/23/2026 19:35	WILLOW LOOP	Cibolo (3)
2026-00011676	Follow Up-Online Report	03/02/2026 23:27	PRICKLY PEAR DR	Cibolo (4)
2026-00013984	Follow Up-Online Report	03/15/2026 10:48	STONEBROOK DR	Cibolo (4)
2026-00011425	Follow Up-Online Report	03/01/2026 15:36	BISON LN	Cibolo (4)
2026-00015452	Follow Up-Online Report	03/22/2026 23:41	CJ JONES CV	Cibolo (4)
2026-00014282	Follow Up-Online Report	03/17/2026 00:31	GOLDENROD CV	Cibolo (1)
2026-00016778	Follow Up-Online Report	03/30/2026 05:06	BAY WILLOW	Cibolo (1)
2026-00017158	Follow Up-Online Report	03/31/2026 20:35	GOLDENROD CV	Cibolo (1)
2026-00016465	Follow Up-Online Report	03/27/2026 20:10	CYPRESS WILLOW	Cibolo (1)
2026-00015811	Follow Up-Online Report	03/24/2026 16:01	WILLOW BLF	Cibolo (1)
2026-00015056	Follow Up-Online Report	03/20/2026 20:21	QUARTER MARE	Cibolo (1)
2026-00015065	Follow Up-Online Report	03/20/2026 20:38	DEAN CHASE	Cibolo (1)
2026-00013055	Follow Up-Online Report	03/10/2026 04:51	HARLEY HAY	Cibolo (1)
2026-00012402	Follow Up-Online Report	03/06/2026 08:46	LA LUNA	Cibolo (2)
2026-00016781	Follow Up-Online Report	03/30/2026 05:42	WEXFORD	Cibolo (2)



Cibolo Police Department Report Call Summary Results



Agency: CPD
Agency #: TX0940600

Print Date/Time: 04/01/2026 08:06
Total Records : 977

Incident Number	Incident Type	Call Date/Time	Location Street Name	Area PD Response Areas
Incident Type: Found Property (9)				
2026-00016907	Found Property	03/30/2026 16:29	TWISTING STREAM	Cibolo (5)
2026-00017119	Found Property	03/31/2026 16:26	LOOP 539 E	Cibolo (5)
2026-00014398	Found Property	03/17/2026 12:40	FM 1103	Cibolo (5)
2026-00014800	Found Property	03/19/2026 10:50	LOOP 539 E	Cibolo (5)
2026-00015122	Found Property	03/20/2026 23:47	HILTON DR	Cibolo (3)
2026-00017045	Found Property	03/31/2026 08:38	LONGHORN WAY	Cibolo (4)
2026-00016610	Found Property	03/28/2026 19:09	IH 35 N	Cibolo (1)
2026-00014868	Found Property	03/19/2026 17:47	MINERALS WAY	Cibolo (1)
2026-00015074	Found Property	03/20/2026 21:02	WEIL RD	Guadalupe County
Incident Type: Fraud (8)				
2026-00016870	Fraud	03/30/2026 13:34	FM 465	Cibolo (6)
2026-00016881	Fraud	03/30/2026 14:39	LOOP 539 E	Cibolo (5)
2026-00017104	Fraud	03/31/2026 15:22	DEW FALL TRL	Cibolo (3)
2026-00012091	Fraud	03/04/2026 15:55	RODEO WAY	Cibolo (4)
2026-00014888	Fraud	03/19/2026 19:48	BLUE WILLOW	Cibolo (1)
2026-00016166	Fraud	03/26/2026 10:39	WESTERN BIT	Cibolo (1)
2026-00014166	Fraud	03/16/2026 10:28	SPRINGTREE BLF	Cibolo (1)
2026-00014102	Fraud	03/16/2026 06:29	GRAVEL GRAY	Cibolo (1)
Incident Type: Harassment (9)				
2026-00016799	Harassment	03/30/2026 07:52	BROAD OAK DR	Cibolo (6)
2026-00012777	Harassment	03/08/2026 05:35	SCOTCH ROSE LN	Cibolo (3)
2026-00017056	Harassment	03/31/2026 09:43	DEER MESA	Cibolo (3)
2026-00014777	Harassment	03/19/2026 09:11	THISTLE CREEK DR	Cibolo (3)
2026-00015530	Harassment	03/23/2026 08:53	DEER MEADOW BLVD	Cibolo (3)
2026-00012040	Harassment	03/04/2026 10:35	DOVE HILL	Cibolo (4)
2026-00014789	Harassment	03/19/2026 10:01	GATEWOOD CLIFF	Cibolo (4)
2026-00012336	Harassment	03/05/2026 20:12	SWIFT MOVE	Cibolo (1)
2026-00011874	Harassment	03/03/2026 15:38	SMOOTH WINE	Cibolo (1)
Incident Type: ID Theft (2)				
2026-00013313	ID Theft	03/11/2026 13:28	DOUGLAS ST	Cibolo (5)
2026-00014357	ID Theft	03/17/2026 08:54	COLEBROOK WAY	Guadalupe County



Cibolo Police Department Report Call Summary

Results



Agency: CPD
Agency #: TX0940600

Print Date/Time: 04/01/2026 08:06
Total Records : 977

Incident Number	Incident Type	Call Date/Time	Location Street Name	Area PD Response Areas
Incident Type: Intoxicated Subject (1)				
2026-00016643	Intoxicated Subject	03/29/2026 00:56	WOODSTONE LOOP	Cibolo (3)
Incident Type: Juvenile Problem (27)				
2026-00011917	Juvenile Problem	03/03/2026 20:46	DROVERS PATH	Bexar County
2026-00015309	Juvenile Problem	03/21/2026 22:31	COUNTRY LN	Cibolo (6)
2026-00012082	Juvenile Problem	03/04/2026 15:20	SCHERTZ PKWY	Schertz (302)
2026-00015635	Juvenile Problem	03/23/2026 18:32	FM 1103	Cibolo (5)
2026-00016597	Juvenile Problem	03/28/2026 17:24	MATTHEW ST	Cibolo (5)
2026-00016072	Juvenile Problem	03/26/2026 00:14	EVERYDAY WAY	Cibolo (5)
2026-00012257	Juvenile Problem	03/05/2026 10:43	FM 1103	Cibolo (5)
2026-00012424	Juvenile Problem	03/06/2026 11:01	FM 1103	Cibolo (5)
2026-00014411	Juvenile Problem	03/17/2026 13:35	FM 1103	Cibolo (5)
2026-00014697	Juvenile Problem	03/18/2026 20:51	FM 1103	Cibolo (5)
2026-00014786	Juvenile Problem	03/19/2026 09:58	FM 1103	Cibolo (5)
2026-00015653	Juvenile Problem	03/23/2026 20:24	BENTWOOD RANCH DR	Cibolo (3)
2026-00015115	Juvenile Problem	03/20/2026 23:09	LANCER HILL	Cibolo (3)
2026-00016626	Juvenile Problem	03/28/2026 22:36	FIREBIRD RUN	Cibolo (3)
2026-00016170	Juvenile Problem	03/26/2026 11:17	THISTLE CREEK DR	Cibolo (3)
2026-00011518	Juvenile Problem	03/02/2026 08:07	W BORGFELD RD	Cibolo (3)
2026-00016859	Juvenile Problem	03/30/2026 12:50	W BORGFELD RD	Cibolo (3)
2026-00012535	Juvenile Problem	03/06/2026 20:53	HAPPY TRL	Cibolo (4)
2026-00015274	Juvenile Problem	03/21/2026 19:16	CIBOLO COMMONS	Cibolo (4)
2026-00015278	Juvenile Problem	03/21/2026 19:44	CIBOLO COMMONS	Cibolo (4)
2026-00011455	Juvenile Problem	03/01/2026 19:19	GATEWOOD BRIAR	Cibolo (4)
2026-00014245	Juvenile Problem	03/16/2026 18:45	STIRRUP DR	Cibolo (4)
2026-00011440	Juvenile Problem	03/01/2026 17:21	FOXGLOVE PASS	Cibolo (1)
2026-00016598	Juvenile Problem	03/28/2026 17:50	LANDMARK HAVEN	Cibolo (2)
2026-00013015	Juvenile Problem	03/09/2026 20:22	ASIAGO	Cibolo (2)
2026-00013738	Juvenile Problem	03/13/2026 19:05	ALBARELLA	Cibolo (2)
2026-00011396	Juvenile Problem	03/01/2026 12:14	TERRAMAR	Cibolo (2)



Cibolo Police Department Report Call Summary

Results



Agency: CPD
Agency #: TX0940600

Print Date/Time: 04/01/2026 08:06
Total Records : 977

Incident Number	Incident Type	Call Date/Time	Location Street Name	Area PD Response Areas
Incident Type: Misc Incident/Info (83)				
2026-00013209	Misc Incident/Info	03/10/2026 23:50	HAECKERVILLE RD	Cibolo (6)
2026-00013729	Misc Incident/Info	03/13/2026 18:17	COUNTRY LN	Cibolo (6)
2026-00016418	Misc Incident/Info	03/27/2026 14:57	COUNTRY LN	Cibolo (6)
2026-00016822	Misc Incident/Info	03/30/2026 10:12	HAECKERVILLE RD	Cibolo (6)
2026-00016909	Misc Incident/Info	03/30/2026 16:36	COUNTRY LN	Cibolo (6)
2026-00011592	Misc Incident/Info	03/02/2026 15:43	BOLTON RD	Cibolo (6)
2026-00011951	Misc Incident/Info	03/04/2026 00:22	ELBEL RD	Schertz (302)
2026-00011796	Misc Incident/Info	03/03/2026 09:19	BRAMBLEWOOD CIR	Cibolo (5)
2026-00012305	Misc Incident/Info	03/05/2026 16:13	ELM ST	Cibolo (5)
2026-00012404	Misc Incident/Info	03/06/2026 09:09	JACQUELINE ST	Cibolo (5)
2026-00014672	Misc Incident/Info	03/18/2026 16:45	MOHAWK DR	Cibolo (5)
2026-00016189	Misc Incident/Info	03/26/2026 12:37	BUFFALO TRL	Cibolo (5)
2026-00014189	Misc Incident/Info	03/16/2026 13:24	CIBOLO VALLEY DR	Cibolo (5)
2026-00014140	Misc Incident/Info	03/16/2026 08:48	FM 1103	Cibolo (5)
2026-00014180	Misc Incident/Info	03/16/2026 11:45	FM 1103	Cibolo (5)
2026-00012023	Misc Incident/Info	03/04/2026 09:56	LOOP 539 E	Cibolo (5)
2026-00012080	Misc Incident/Info	03/04/2026 15:09	LOOP 539 E	Cibolo (5)
2026-00012482	Misc Incident/Info	03/06/2026 17:01	LOOP 539 E	Cibolo (5)
2026-00012497	Misc Incident/Info	03/06/2026 18:10	LOOP 539 E	Cibolo (5)
2026-00013088	Misc Incident/Info	03/10/2026 09:48	LOOP 539 E	Cibolo (5)
2026-00013307	Misc Incident/Info	03/11/2026 12:51	LOOP 539 E	Cibolo (5)
2026-00013679	Misc Incident/Info	03/13/2026 13:19	LOOP 539 E	Cibolo (5)
2026-00014236	Misc Incident/Info	03/16/2026 18:19	LOOP 539 E	Cibolo (5)
2026-00014884	Misc Incident/Info	03/19/2026 19:14	LOOP 539 E	Cibolo (5)
2026-00015044	Misc Incident/Info	03/20/2026 18:52	LOOP 539 E	Cibolo (5)
2026-00015767	Misc Incident/Info	03/24/2026 12:37	LOOP 539 E	Cibolo (5)
2026-00012705	Misc Incident/Info	03/07/2026 21:11	CIBOLO VALLEY DR	Cibolo (5)
2026-00017117	Misc Incident/Info	03/31/2026 16:21	CIBOLO VALLEY DR	Cibolo (5)
2026-00014865	Misc Incident/Info	03/19/2026 17:18	FM 1103	Cibolo (5)
2026-00013064	Misc Incident/Info	03/10/2026 06:46	CIBOLO VALLEY DR	Cibolo (5)
2026-00015611	Misc Incident/Info	03/23/2026 15:54	FM 1103	Cibolo (5)



Cibolo Police Department Report Call Summary

Results



Agency: CPD
Agency #: TX0940600

Print Date/Time: 04/01/2026 08:06
Total Records : 977

Incident Number	Incident Type	Call Date/Time	Location Street Name	Area PD Response Areas
2026-00015208	Misc Incident/Info	03/21/2026 09:27	FM 1103	Cibolo (5)
2026-00012284	Misc Incident/Info	03/05/2026 13:50	CIBOLO VALLEY DR	Cibolo (5)
2026-00011815	Misc Incident/Info	03/03/2026 10:50	MOHAWK DR	Cibolo (5)
2026-00014841	Misc Incident/Info	03/19/2026 15:54	S MAIN ST	Cibolo (5)
2026-00012958	Misc Incident/Info	03/09/2026 13:24	FM 1103	Cibolo (5)
2026-00012683	Misc Incident/Info	03/07/2026 18:30	TIERRA GRANDE	Cibolo (3)
2026-00013556	Misc Incident/Info	03/12/2026 19:49	SPICE OAK LN	Cibolo (3)
2026-00013333	Misc Incident/Info	03/11/2026 16:22	LACELEAF LN	Cibolo (3)
2026-00016683	Misc Incident/Info	03/29/2026 10:27	HAWK CIR	Cibolo (3)
2026-00011855	Misc Incident/Info	03/03/2026 14:05	DEER CREEK BLVD	Cibolo (3)
2026-00016657	Misc Incident/Info	03/29/2026 06:45	DEER CREEK BLVD	Cibolo (3)
2026-00011856	Misc Incident/Info	03/03/2026 14:06	DEER CREEK BLVD	Cibolo (3)
2026-00016658	Misc Incident/Info	03/29/2026 06:45	DEER CREEK BLVD	Cibolo (3)
2026-00015583	Misc Incident/Info	03/23/2026 14:12	OAKMONT WAY	Cibolo (3)
2026-00014877	Misc Incident/Info	03/19/2026 18:31	CORDERO DR	Cibolo (3)
2026-00015552	Misc Incident/Info	03/23/2026 10:52	DEER CREEK BLVD	Cibolo (3)
2026-00015704	Misc Incident/Info	03/24/2026 06:56	OAKMONT WAY	Cibolo (3)
2026-00014220	Misc Incident/Info	03/16/2026 16:18	PARKFAIR GATE	Cibolo (3)
2026-00016405	Misc Incident/Info	03/27/2026 13:46	DEER MEADOW BLVD	Cibolo (3)
2026-00016929	Misc Incident/Info	03/30/2026 18:46	CIBOLO VALLEY DR	Cibolo (3)
2026-00015735	Misc Incident/Info	03/24/2026 08:57	W BORGFELD RD	Cibolo (3)
2026-00015553	Misc Incident/Info	03/23/2026 10:54	DEER CREEK BLVD	Cibolo (3)
2026-00011827	Misc Incident/Info	03/03/2026 12:04	W BORGFELD RD	Cibolo (3)
2026-00011850	Misc Incident/Info	03/03/2026 13:47	CANTON CHASE	Cibolo (4)
2026-00012698	Misc Incident/Info	03/07/2026 20:23	GROOMS RD	Cibolo (4)
2026-00016258	Misc Incident/Info	03/26/2026 18:54	CIBOLO COMMONS	Cibolo (4)
2026-00014627	Misc Incident/Info	03/18/2026 13:33	FM 1103	Cibolo (4)
2026-00012737	Misc Incident/Info	03/07/2026 23:55	SADDLEHORN WAY	Cibolo (4)
2026-00012938	Misc Incident/Info	03/09/2026 10:55	ARCADIA PLACE	Cibolo (4)
2026-00013661	Misc Incident/Info	03/13/2026 11:19	SADDLE VISTA	Cibolo (4)



Cibolo Police Department Report Call Summary Results



Agency: CPD
Agency #: TX0940600

Print Date/Time: 04/01/2026 08:06
Total Records : 977

Incident Number	Incident Type	Call Date/Time	Location Street Name	Area PD Response Areas
2026-00015093	Misc Incident/Info	03/20/2026 22:04	PRAIRIE VISTA	Cibolo (4)
2026-00014797	Misc Incident/Info	03/19/2026 10:34	STIRRUP DR	Cibolo (4)
2026-00015548	Misc Incident/Info	03/23/2026 10:11	BISON LN	Cibolo (4)
2026-00016656	Misc Incident/Info	03/29/2026 06:44	GATEWOOD BRIAR	Cibolo (4)
2026-00016721	Misc Incident/Info	03/29/2026 15:36	HINGE CHASE	Cibolo (4)
2026-00014598	Misc Incident/Info	03/18/2026 11:06	ELAINE S SCHLATHER PKWY	Cibolo (1)
2026-00016386	Misc Incident/Info	03/27/2026 11:26	SPRINGTREE CV	Cibolo (1)
2026-00017109	Misc Incident/Info	03/31/2026 15:36	SPRINGTREE CV	Cibolo (1)
2026-00015565	Misc Incident/Info	03/23/2026 12:22	N WILLOW WAY	Cibolo (1)
2026-00014988	Misc Incident/Info	03/20/2026 12:15	SPRINGTREE PKWY	Cibolo (1)
2026-00016557	Misc Incident/Info	03/28/2026 11:03	WILLOW RUN	Cibolo (1)
2026-00016749	Misc Incident/Info	03/29/2026 21:03	S WILLOW WAY	Cibolo (1)
2026-00015854	Misc Incident/Info	03/24/2026 21:35	SWIFT MOVE	Cibolo (1)
2026-00015227	Misc Incident/Info	03/21/2026 12:13	SPRINGTREE CIR	Cibolo (1)
2026-00014157	Misc Incident/Info	03/16/2026 09:54	WILLOW WOOD	Cibolo (1)
2026-00011375	Misc Incident/Info	03/01/2026 10:52	BROOKHILL	Cibolo (1)
2026-00015815	Misc Incident/Info	03/24/2026 16:08	BROOK VW	Cibolo (1)
2026-00011452	Misc Incident/Info	03/01/2026 18:46	SPRINGTREE CV	Cibolo (1)
2026-00013463	Misc Incident/Info	03/12/2026 10:03	GRAVEL GRAY	Cibolo (1)
2026-00013690	Misc Incident/Info	03/13/2026 14:46	LANDMARK PASS	Cibolo (2)
2026-00015394	Misc Incident/Info	03/22/2026 12:59	LANDMARK BLF	Cibolo (2)
2026-00012309	Misc Incident/Info	03/05/2026 16:59	FOXTAIL CANYON	Cibolo (2)
Incident Type: Missing Person-Adult (1)				
2026-00015703	Missing Person-Adult	03/24/2026 06:55	HAZELTINE WAY	Cibolo (3)
Incident Type: Robbery (1)				
2026-00013757	Robbery	03/13/2026 21:01	SPRINGTREE HOLW	Cibolo (1)
Incident Type: Runaway (2)				
2026-00016970	Runaway	03/30/2026 22:26	TIERRA GRANDE	Cibolo (3)
2026-00015849	Runaway	03/24/2026 21:08	SLIPPERY ROCK	Cibolo (4)
Incident Type: Special Detail (7)				
2026-00013815	Special Detail	03/14/2026 11:03	LANCE CROSSING	Cibolo (5)



Cibolo Police Department Report Call Summary Results



Agency: CPD
Agency #: TX0940600

Print Date/Time: 04/01/2026 08:06
Total Records : 977

Incident Number	Incident Type	Call Date/Time	Location Street Name	Area PD Response Areas
2026-00013288	Special Detail	03/11/2026 11:37	S MAIN ST	Cibolo (5)
2026-00015930	Special Detail	03/25/2026 08:51	S MAIN ST	Cibolo (5)
2026-00012380	Special Detail	03/06/2026 06:34	THISTLE CREEK DR	Cibolo (3)
2026-00016548	Special Detail	03/28/2026 09:31	W BORGFELD RD	Cibolo (3)
2026-00017106	Special Detail	03/31/2026 15:37	DEER MEADOW BLVD	Cibolo (3)
2026-00016333	Special Detail	03/27/2026 06:44	ELAINE S SCHLATHER PKWY	Cibolo (1)
Incident Type: Suicide /Attempt (3)				
2026-00013856	Suicide /Attempt	03/14/2026 16:14	SAILORS WAY	Cibolo (5)
2026-00015409	Suicide /Attempt	03/22/2026 15:54	WILLOW LOOP	Cibolo (3)
2026-00017038	Suicide /Attempt	03/31/2026 08:11	HOLLAND PARK	Cibolo (4)
Incident Type: Suicide Threat (2)				
2026-00014388	Suicide Threat	03/17/2026 11:27	FALCON DR	Cibolo (6)
2026-00011590	Suicide Threat	03/02/2026 15:25	HANA LN	Cibolo (5)
Incident Type: Susp-Gun Shots Heard (4)				
2026-00013877	Susp-Gun Shots Heard	03/14/2026 19:43	SASSMAN RD	Cibolo (5)
2026-00012773	Susp-Gun Shots Heard	03/08/2026 03:50	CIBOLO TOLLE RD	Cibolo (5)
2026-00016582	Susp-Gun Shots Heard	03/28/2026 16:12	HIDDEN CAVE	Cibolo (3)
2026-00015346	Susp-Gun Shots Heard	03/22/2026 01:47	W BORGFELD RD	Cibolo (3)
Incident Type: Suspicious (52)				
2026-00011628	Suspicious	03/02/2026 19:56	MOOSE TRL	Cibolo (6)
2026-00012693	Suspicious	03/07/2026 20:02	STAG WAY	Cibolo (6)
2026-00016448	Suspicious	03/27/2026 18:35	SAMBAR MAIN	Cibolo (6)
2026-00014490	Suspicious	03/17/2026 20:53	LOWER SEGUIN RD	Cibolo (6)
2026-00011525	Suspicious	03/02/2026 08:28	COUNTRY LN	Cibolo (6)
2026-00013504	Suspicious	03/12/2026 14:31	COUNTRY LN	Cibolo (6)
2026-00012469	Suspicious	03/06/2026 15:38	FM 78 W	Cibolo (6)
2026-00013319	Suspicious	03/11/2026 14:07	FM 78 E	Cibolo (6)
2026-00012666	Suspicious	03/07/2026 16:00	HAECKERVILLE RD	Cibolo (6)
2026-00013115	Suspicious	03/10/2026 12:10	HAECKERVILLE RD	Cibolo (6)
2026-00013180	Suspicious	03/10/2026 19:36	HAECKERVILLE RD	Cibolo (6)



Cibolo Police Department Report Call Summary

Results



Agency: CPD
Agency #: TX0940600

Print Date/Time: 04/01/2026 08:06
Total Records : 977

Incident Number	Incident Type	Call Date/Time	Location Street Name	Area PD Response Areas
2026-00016521	Suspicious	03/28/2026 04:59	S MAIN ST	Cibolo (6)
2026-00014073	Suspicious	03/15/2026 23:43	MEEK ST	Cibolo (5)
2026-00011922	Suspicious	03/03/2026 21:12	DOBIE BLVD	Cibolo (5)
2026-00012729	Suspicious	03/07/2026 23:06	EVERYDAY WAY	Cibolo (5)
2026-00013427	Suspicious	03/12/2026 04:13	CIBOLO VALLEY DR	Cibolo (5)
2026-00016093	Suspicious	03/26/2026 02:51	FM 1103	Cibolo (5)
2026-00012328	Suspicious	03/05/2026 18:52	LOOP 539 E	Cibolo (5)
2026-00012367	Suspicious	03/06/2026 01:40	FM 1103	Cibolo (5)
2026-00012506	Suspicious	03/06/2026 18:54	FM 1103	Cibolo (5)
2026-00011491	Suspicious	03/02/2026 03:59	HANA LN	Cibolo (5)
2026-00014316	Suspicious	03/17/2026 04:03	CIBOLO VALLEY DR	Cibolo (5)
2026-00012636	Suspicious	03/07/2026 11:34	KITTY HAWK RUN	Cibolo (3)
2026-00011915	Suspicious	03/03/2026 20:19	TIERRA GRANDE	Cibolo (3)
2026-00011647	Suspicious	03/02/2026 21:32	DEER MEADOW BLVD	Cibolo (3)
2026-00014260	Suspicious	03/16/2026 21:50	KIPPER AVE	Cibolo (3)
2026-00011562	Suspicious	03/02/2026 12:35	EGLINGTON WAY	Cibolo (3)
2026-00014908	Suspicious	03/19/2026 23:17	ARMOUR DR	Cibolo (3)
2026-00017169	Suspicious	03/31/2026 21:54	SOMERSET AVE	Cibolo (3)
2026-00012557	Suspicious	03/06/2026 23:16	BISON LN	Cibolo (4)
2026-00011653	Suspicious	03/02/2026 22:01	WIEDNER RD	Cibolo (4)
2026-00011930	Suspicious	03/03/2026 22:21	WIEDNER RD	Cibolo (4)
2026-00012551	Suspicious	03/06/2026 22:24	WIEDNER RD	Cibolo (4)
2026-00012555	Suspicious	03/06/2026 23:12	WIEDNER RD	Cibolo (4)
2026-00015460	Suspicious	03/23/2026 00:37	WIEDNER RD	Cibolo (4)
2026-00015470	Suspicious	03/23/2026 02:50	WIEDNER RD	Cibolo (4)
2026-00011461	Suspicious	03/01/2026 20:22	KNIGHTS RUN	Cibolo (4)
2026-00015168	Suspicious	03/21/2026 03:04	PRICKLY PEAR DR	Cibolo (4)
2026-00016151	Suspicious	03/26/2026 09:18	SLIPPERY ROCK	Cibolo (4)
2026-00015679	Suspicious	03/24/2026 02:01	IH 35 N	Cibolo (1)
2026-00012569	Suspicious	03/07/2026 00:13	CIBOLO VALLEY DR	Cibolo (1)
2026-00012157	Suspicious	03/04/2026 21:46	KINGS WAY	Cibolo (1)
2026-00012745	Suspicious	03/08/2026 00:48	KINGS WAY	Cibolo (1)



Cibolo Police Department Report Call Summary Results



Agency: CPD
Agency #: TX0940600

Print Date/Time: 04/01/2026 08:06
Total Records : 977

Incident Number	Incident Type	Call Date/Time	Location Street Name	Area PD Response Areas
2026-00015893	Suspicious	03/25/2026 02:57	CIBOLO VALLEY DR	Cibolo (1)
2026-00011624	Suspicious	03/02/2026 19:00	WILLOW RUN	Cibolo (1)
2026-00012009	Suspicious	03/04/2026 08:45	SPRINGTREE BLF	Cibolo (1)
2026-00012427	Suspicious	03/06/2026 11:13	WILLOW VW	Cibolo (1)
2026-00012661	Suspicious	03/07/2026 14:52	TOWER BLF	Cibolo (1)
2026-00012639	Suspicious	03/07/2026 12:09	BLAZE MOON	Cibolo (1)
2026-00013769	Suspicious	03/13/2026 22:18	FM 1103	Cibolo (2)
2026-00012901	Suspicious	03/09/2026 03:34	LANDMARK PARK	Cibolo (2)
2026-00012337	Suspicious	03/05/2026 20:24	LANDMARK FALLS	Cibolo (2)
Incident Type: Suspicious-Package (1)				
2026-00012932	Suspicious-Package	03/09/2026 10:18	COTORRA SPGS	Cibolo (2)
Incident Type: Theft (12)				
2026-00011532	Theft	03/02/2026 09:19	GUADALUPE DR	Cibolo (5)
2026-00016255	Theft	03/26/2026 18:40	FM 1103	Cibolo (5)
2026-00014170	Theft	03/16/2026 10:55	CIBOLO VALLEY DR	Cibolo (5)
2026-00014710	Theft	03/18/2026 22:24	CIBOLO VALLEY DR	Cibolo (5)
2026-00014976	Theft	03/20/2026 11:13	FM 1103	Cibolo (5)
2026-00011814	Theft	03/03/2026 10:45	GRAND AVE	Cibolo (3)
2026-00016950	Theft	03/30/2026 20:50	NOTCHLEAF	Cibolo (3)
2026-00012016	Theft	03/04/2026 09:09	BURKWOOD LN	Cibolo (3)
2026-00011599	Theft	03/02/2026 16:54	GROOMS RD	Cibolo (4)
2026-00012090	Theft	03/04/2026 15:54	RODEO WAY	Cibolo (4)
2026-00013063	Theft	03/10/2026 06:13	BUCKBOARD LN	Cibolo (4)
2026-00016595	Theft	03/28/2026 17:16	CALIBAN	Cibolo (2)
Incident Type: Theft- Shoplifter (3)				
2026-00014791	Theft- Shoplifter	03/19/2026 10:22	CIBOLO VALLEY DR	Cibolo (5)
2026-00016607	Theft- Shoplifter	03/28/2026 19:05	FM 1103	Cibolo (5)
2026-00012505	Theft- Shoplifter	03/06/2026 18:51	SCHNEIDER DR	Cibolo (5)
Incident Type: Theft- Vehicle (2)				
2026-00012285	Theft- Vehicle	03/05/2026 13:23	BROAD OAK DR	Cibolo (6)
2026-00014167	Theft- Vehicle	03/16/2026 10:26	FM 78 W	Cibolo (6)



Cibolo Police Department Report Call Summary Results



Agency: CPD
Agency #: TX0940600

Print Date/Time: 04/01/2026 08:06
Total Records : 977

Incident Number	Incident Type	Call Date/Time	Location Street Name	Area PD Response Areas
Incident Type: Threats (10)				
2026-00012334	Threats	03/05/2026 19:45	RAY CORBETT DR	Schertz (505)
2026-00013069	Threats	03/10/2026 07:45	LOOP 539 E	Cibolo (5)
2026-00014881	Threats	03/19/2026 18:53	CIRRUS CV	Cibolo (3)
2026-00012463	Threats	03/06/2026 14:47	THISTLE CREEK DR	Cibolo (3)
2026-00011565	Threats	03/02/2026 13:08	W BORGFELD RD	Cibolo (3)
2026-00016868	Threats	03/30/2026 13:26	W BORGFELD RD	Cibolo (3)
2026-00015017	Threats	03/20/2026 14:52	ELAINE S SCHLATHER PKWY	Cibolo (1)
2026-00014055	Threats	03/15/2026 21:45	WILLOW RUN	Cibolo (1)
2026-00012653	Threats	03/07/2026 14:18	WILLOW VW	Cibolo (1)
2026-00012810	Threats	03/08/2026 14:30	WEXFORD	Cibolo (2)
Incident Type: Traffic Compl/Reckless (60)				
2026-00011711	Traffic Compl/Reckless	03/03/2026 02:35	FM 78 E	Cibolo (6)
2026-00014752	Traffic Compl/Reckless	03/19/2026 05:49	FM 78 E	Cibolo (6)
2026-00013859	Traffic Compl/Reckless	03/14/2026 16:49	IH 10 W	Cibolo (6)
2026-00012198	Traffic Compl/Reckless	03/05/2026 06:42	IH 10 W	Cibolo (6)
2026-00015693	Traffic Compl/Reckless	03/24/2026 05:15	IH 10 W	Cibolo (6)
2026-00015256	Traffic Compl/Reckless	03/21/2026 16:04	IH 10 W	Cibolo (6)
2026-00013473	Traffic Compl/Reckless	03/12/2026 11:14	IH 10 W	Cibolo (6)
2026-00014062	Traffic Compl/Reckless	03/15/2026 22:23	IH 10 W	Cibolo (6)
2026-00016650	Traffic Compl/Reckless	03/29/2026 02:31	IH 10 W	Cibolo (6)
2026-00016890	Traffic Compl/Reckless	03/30/2026 15:15	IH 10 W	Cibolo (6)
2026-00011467	Traffic Compl/Reckless	03/01/2026 21:12	IH 10 W	Cibolo (6)
2026-00015404	Traffic Compl/Reckless	03/22/2026 14:53	IH 10 W	Cibolo (6)
2026-00015414	Traffic Compl/Reckless	03/22/2026 17:14	IH 10 W	Cibolo (6)
2026-00012318	Traffic Compl/Reckless	03/05/2026 18:06	IH 10 W	Cibolo (6)
2026-00013886	Traffic Compl/Reckless	03/14/2026 20:37	IH 10 W	Cibolo (6)



Cibolo Police Department Report Call Summary Results



Agency: CPD
Agency #: TX0940600

Print Date/Time: 04/01/2026 08:06
Total Records : 977

Incident Number	Incident Type	Call Date/Time	Location Street Name	Area PD Response Areas
2026-00011890	Traffic Compl/Reckless	03/03/2026 17:20	FM 78 W	Cibolo (6)
2026-00012320	Traffic Compl/Reckless	03/05/2026 18:15	FM 3009	Schertz (302)
2026-00011816	Traffic Compl/Reckless	03/03/2026 10:51	BRAMBLEWOOD CIR	Cibolo (5)
2026-00016271	Traffic Compl/Reckless	03/26/2026 20:40	FM 1103	Cibolo (5)
2026-00012583	Traffic Compl/Reckless	03/07/2026 01:00	N MAIN ST	Cibolo (5)
2026-00013193	Traffic Compl/Reckless	03/10/2026 21:20	CIBOLO VALLEY DR	Cibolo (5)
2026-00014464	Traffic Compl/Reckless	03/17/2026 17:29	FM 1103	Cibolo (5)
2026-00016902	Traffic Compl/Reckless	03/30/2026 15:57	CIBOLO VALLEY DR	Cibolo (5)
2026-00014020	Traffic Compl/Reckless	03/15/2026 15:21	FM 78 E	Cibolo (5)
2026-00016742	Traffic Compl/Reckless	03/29/2026 20:12	FM 78 E	Cibolo (5)
2026-00015067	Traffic Compl/Reckless	03/20/2026 20:47	S MAIN ST	Cibolo (5)
2026-00016240	Traffic Compl/Reckless	03/26/2026 17:18	FM 78 W	Cibolo (5)
2026-00012247	Traffic Compl/Reckless	03/05/2026 09:35	TOWN CREEK RD	Cibolo (3)
2026-00014179	Traffic Compl/Reckless	03/16/2026 11:48	RIO VISTA DR	Cibolo (3)
2026-00014152	Traffic Compl/Reckless	03/16/2026 09:41	RIO VISTA DR	Cibolo (3)
2026-00014205	Traffic Compl/Reckless	03/16/2026 15:24	RIO VISTA DR	Cibolo (3)
2026-00014437	Traffic Compl/Reckless	03/17/2026 15:37	RIO VISTA DR	Cibolo (3)
2026-00015110	Traffic Compl/Reckless	03/20/2026 23:03	RIO VISTA DR	Cibolo (3)
2026-00015203	Traffic Compl/Reckless	03/21/2026 09:11	RIO VISTA DR	Cibolo (3)
2026-00011955	Traffic Compl/Reckless	03/04/2026 01:08	CIBOLO VALLEY DR	Cibolo (3)
2026-00014658	Traffic Compl/Reckless	03/18/2026 15:37	RIO VISTA DR	Cibolo (3)
2026-00014210	Traffic Compl/Reckless	03/16/2026 15:38	EVERYDAY WAY	Cibolo (3)
2026-00013876	Traffic Compl/Reckless	03/14/2026 19:38	FALLING SUN	Cibolo (3)
2026-00014690	Traffic Compl/Reckless	03/18/2026 20:28	IH 35 N	Schertz (201)
2026-00013269	Traffic Compl/Reckless	03/11/2026 10:10	GATEWOOD CLIFF	Cibolo (4)



Cibolo Police Department Report Call Summary Results



Agency: CPD
Agency #: TX0940600

Print Date/Time: 04/01/2026 08:06
Total Records : 977

Incident Number	Incident Type	Call Date/Time	Location Street Name	Area PD Response Areas
2026-00013134	Traffic Compl/Reckless	03/10/2026 14:56	CANTERBURY HILL	Cibolo (4)
2026-00013135	Traffic Compl/Reckless	03/10/2026 14:48	CJ JONES CV	Cibolo (4)
2026-00011374	Traffic Compl/Reckless	03/01/2026 10:39	GATEWOOD BRIAR	Cibolo (4)
2026-00011993	Traffic Compl/Reckless	03/04/2026 08:02	GATEWOOD BRIAR	Cibolo (4)
2026-00012221	Traffic Compl/Reckless	03/05/2026 08:05	GATEWOOD BRIAR	Cibolo (4)
2026-00015774	Traffic Compl/Reckless	03/24/2026 13:24	GATEWOOD BRIAR	Cibolo (4)
2026-00012118	Traffic Compl/Reckless	03/04/2026 18:35	ARCADIA PLACE	Cibolo (4)
2026-00014782	Traffic Compl/Reckless	03/19/2026 09:40	BRAHMA WAY	Cibolo (4)
2026-00012014	Traffic Compl/Reckless	03/04/2026 09:02	CIBOLO VALLEY DR	Cibolo (1)
2026-00014400	Traffic Compl/Reckless	03/17/2026 12:45	WILLOW POINTE	Cibolo (1)
2026-00014403	Traffic Compl/Reckless	03/17/2026 12:54	WEEPING WILLOW	Cibolo (1)
2026-00011737	Traffic Compl/Reckless	03/03/2026 05:03	CIBOLO VALLEY DR	Cibolo (1)
2026-00016830	Traffic Compl/Reckless	03/30/2026 10:45	FM 1103	Cibolo (2)
2026-00012175	Traffic Compl/Reckless	03/05/2026 00:28	FM 1103	Cibolo (2)
2026-00016676	Traffic Compl/Reckless	03/29/2026 09:41	FM 1103	Cibolo (2)
2026-00011509	Traffic Compl/Reckless	03/02/2026 07:35	GREEN VALLEY RD	Cibolo (2)
2026-00012987	Traffic Compl/Reckless	03/09/2026 15:48	STRESA	Cibolo (2)
2026-00013739	Traffic Compl/Reckless	03/13/2026 19:10	CANSIGLIO	Cibolo (2)
2026-00011935	Traffic Compl/Reckless	03/03/2026 22:36	GREEN VALLEY RD	Cibolo (2)
2026-00012827	Traffic Compl/Reckless	03/08/2026 19:41	GREEN VALLEY RD	Cibolo (2)
Incident Type: Traffic Complaint-Road Rage (2)				
2026-00014418	Traffic Complaint-Road Rage	03/17/2026 14:02	CIBOLO VALLEY DR	Cibolo (5)
2026-00012489	Traffic Complaint-Road Rage	03/06/2026 17:34	CIBOLO VALLEY DR	Cibolo (1)
Incident Type: Traffic Hazard/Contl (21)				
2026-00015756	Traffic Hazard/Contl	03/24/2026 11:05	FM 78 W	Cibolo (6)



Cibolo Police Department Report Call Summary Results



Agency: CPD
Agency #: TX0940600

Print Date/Time: 04/01/2026 08:06
Total Records : 977

Incident Number	Incident Type	Call Date/Time	Location Street Name	Area PD Response Areas
2026-00015006	Traffic Hazard/Contl	03/20/2026 14:06	IH 10 W	Cibolo (6)
2026-00016813	Traffic Hazard/Contl	03/30/2026 09:08	FM 78 E	Cibolo (6)
2026-00011304	Traffic Hazard/Contl	03/01/2026 02:22	IH 10 W	Cibolo (6)
2026-00016507	Traffic Hazard/Contl	03/28/2026 01:02	IH 10 W	Cibolo (6)
2026-00016238	Traffic Hazard/Contl	03/26/2026 17:05	FM 1103	Cibolo (5)
2026-00016163	Traffic Hazard/Contl	03/26/2026 10:22	FM 1103	Cibolo (5)
2026-00015529	Traffic Hazard/Contl	03/23/2026 08:50	FM 78 E	Cibolo (5)
2026-00012853	Traffic Hazard/Contl	03/08/2026 22:38	FM 1103	Cibolo (5)
2026-00011535	Traffic Hazard/Contl	03/02/2026 09:47	TOWN CREEK RD	Cibolo (3)
2026-00015019	Traffic Hazard/Contl	03/20/2026 15:06	TOWN CREEK RD	Cibolo (3)
2026-00011589	Traffic Hazard/Contl	03/02/2026 15:27	TOWN CREEK RD	Cibolo (3)
2026-00016756	Traffic Hazard/Contl	03/29/2026 22:28	DEER CREEK BLVD	Cibolo (3)
2026-00014963	Traffic Hazard/Contl	03/20/2026 09:11	TOWN CREEK RD	Cibolo (3)
2026-00014381	Traffic Hazard/Contl	03/17/2026 10:53	BRUSH TRAIL BEND	Cibolo (3)
2026-00011593	Traffic Hazard/Contl	03/02/2026 16:00	DEAN RD	Cibolo (3)
2026-00014453	Traffic Hazard/Contl	03/17/2026 16:40	FM 1103	Cibolo (4)
2026-00016930	Traffic Hazard/Contl	03/30/2026 18:58	FM 1103	Cibolo (4)
2026-00012065	Traffic Hazard/Contl	03/04/2026 13:34	GATEWOOD OAKS	Cibolo (4)
2026-00016490	Traffic Hazard/Contl	03/27/2026 22:19	FM 1103	Cibolo (2)
2026-00012018	Traffic Hazard/Contl	03/04/2026 09:23	FM 1103	Cibolo (2)
Incident Type: Trespassing (8)				
2026-00012647	Trespassing	03/07/2026 13:02	FM 78 W	Cibolo (6)
2026-00012946	Trespassing	03/09/2026 11:52	FM 78 W	Cibolo (6)
2026-00011897	Trespassing	03/03/2026 18:01	CIBOLO VALLEY DR	Cibolo (5)
2026-00012330	Trespassing	03/05/2026 19:10	CIBOLO VALLEY DR	Cibolo (5)
2026-00011958	Trespassing	03/04/2026 01:27	FM 1103	Cibolo (5)



Cibolo Police Department Report Call Summary Results



Agency: CPD
Agency #: TX0940600

Print Date/Time: 04/01/2026 08:06
Total Records : 977

Incident Number	Incident Type	Call Date/Time	Location Street Name	Area PD Response Areas
2026-00012052	Trespassing	03/04/2026 11:31	GATEWOOD OAKS	Cibolo (4)
2026-00014707	Trespassing	03/18/2026 21:49	PRAIRIE VISTA	Cibolo (4)
2026-00012627	Trespassing	03/07/2026 10:23	CREEK SIDE DR	Cibolo (1)
Incident Type: Welfare Check/M H Crisis (15)				
2026-00013997	Welfare Check/M H Crisis	03/15/2026 11:42	CAPE NEDDICK	Cibolo (5)
2026-00014878	Welfare Check/M H Crisis	03/19/2026 18:41	CIBOLO VALLEY DR	Cibolo (5)
2026-00015819	Welfare Check/M H Crisis	03/24/2026 16:40	SINGING BROOK	Cibolo (5)
2026-00016498	Welfare Check/M H Crisis	03/27/2026 23:03	SINGING BROOK	Cibolo (5)
2026-00016516	Welfare Check/M H Crisis	03/28/2026 02:40	SINGING BROOK	Cibolo (5)
2026-00014427	Welfare Check/M H Crisis	03/17/2026 15:07	FM 1103	Cibolo (5)
2026-00016032	Welfare Check/M H Crisis	03/25/2026 19:39	FM 1103	Cibolo (5)
2026-00014064	Welfare Check/M H Crisis	03/15/2026 22:26	MEEK ST	Cibolo (5)
2026-00016617	Welfare Check/M H Crisis	03/28/2026 20:40	DEW FALL TRL	Cibolo (3)
2026-00015423	Welfare Check/M H Crisis	03/22/2026 19:59	PORTRUSH LN	Cibolo (3)
2026-00016767	Welfare Check/M H Crisis	03/29/2026 23:40	GREEN BROOK PL	Cibolo (1)
2026-00014022	Welfare Check/M H Crisis	03/15/2026 15:36	GRAVEL GRAY	Cibolo (1)
2026-00013682	Welfare Check/M H Crisis	03/13/2026 13:48	PERSIMMON DR	Cibolo (1)
2026-00016161	Welfare Check/M H Crisis	03/26/2026 10:17	MARBELLA	Cibolo (2)
2026-00011387	Welfare Check/M H Crisis	03/01/2026 11:48	TERRAMAR	Cibolo (2)
Incident Type: Welfare Concern (38)				
2026-00013145	Welfare Concern	03/10/2026 15:39	BROAD OAK DR	Cibolo (6)
2026-00016679	Welfare Concern	03/29/2026 10:14	LOGGY BAYOU	Cibolo (6)
2026-00016832	Welfare Concern	03/30/2026 10:55	AXIS VALLEY	Cibolo (6)
2026-00016615	Welfare Concern	03/28/2026 20:14	BROAD OAK DR	Cibolo (6)
2026-00011517	Welfare Concern	03/02/2026 08:05	COUNTRY LN	Cibolo (6)
2026-00012454	Welfare Concern	03/06/2026 14:01	LOWER SEGUIN RD	Cibolo (6)
2026-00014933	Welfare Concern	03/20/2026 07:02	ROBIN DR	Cibolo (6)
2026-00016957	Welfare Concern	03/30/2026 21:29	FM 78 E	Cibolo (6)



Cibolo Police Department Report Call Summary Results



Agency: CPD
Agency #: TX0940600

Print Date/Time: 04/01/2026 08:06
Total Records : 977

Incident Number	Incident Type	Call Date/Time	Location Street Name	Area PD Response Areas
2026-00013143	Welfare Concern	03/10/2026 15:33	HAECKERVILLE RD	Cibolo (6)
2026-00013973	Welfare Concern	03/15/2026 09:56	BORGFELD RD	Schertz (301)
2026-00012475	Welfare Concern	03/06/2026 15:52	COUNTRY LN	Cibolo (5)
2026-00012044	Welfare Concern	03/04/2026 10:50	FM 1103	Cibolo (5)
2026-00012460	Welfare Concern	03/06/2026 14:26	FM 1103	Cibolo (5)
2026-00013894	Welfare Concern	03/14/2026 21:48	FM 1103	Cibolo (5)
2026-00014230	Welfare Concern	03/16/2026 17:41	FM 1103	Cibolo (5)
2026-00016154	Welfare Concern	03/26/2026 09:29	FM 1103	Cibolo (5)
2026-00011564	Welfare Concern	03/02/2026 12:49	FM 1103	Cibolo (5)
2026-00015636	Welfare Concern	03/23/2026 18:38	BUFFALO TRL	Cibolo (5)
2026-00012525	Welfare Concern	03/06/2026 20:28	W BORGFELD RD	Cibolo (5)
2026-00014225	Welfare Concern	03/16/2026 17:00	ABLE BLF	Cibolo (5)
2026-00011662	Welfare Concern	03/02/2026 22:35	TOLLE RD	Cibolo (5)
2026-00013142	Welfare Concern	03/10/2026 15:16	HANA LN	Cibolo (5)
2026-00013461	Welfare Concern	03/12/2026 09:52	HANA LN	Cibolo (5)
2026-00014288	Welfare Concern	03/17/2026 00:47	SOMERSET AVE	Cibolo (3)
2026-00016225	Welfare Concern	03/26/2026 15:59	SOMERSET AVE	Cibolo (3)
2026-00011891	Welfare Concern	03/03/2026 17:23	CATTLE RUN	Cibolo (4)
2026-00015355	Welfare Concern	03/22/2026 02:38	FM 1103	Cibolo (4)
2026-00014000	Welfare Concern	03/15/2026 12:32	RANCH HOUSE RD	Cibolo (4)
2026-00011433	Welfare Concern	03/01/2026 16:27	BRASHER CV	Cibolo (4)
2026-00014059	Welfare Concern	03/15/2026 22:11	BLUE WILLOW	Cibolo (1)
2026-00012467	Welfare Concern	03/06/2026 15:30	SPRINGTREE CV	Cibolo (1)
2026-00012695	Welfare Concern	03/07/2026 20:07	WILLOW VW	Cibolo (1)
2026-00015011	Welfare Concern	03/20/2026 14:31	CIBOLO VALLEY DR	Cibolo (1)
2026-00012229	Welfare Concern	03/05/2026 08:17	FM 1103	Cibolo (2)
2026-00016944	Welfare Concern	03/30/2026 20:24	PIONEER JUNCTION	Cibolo (2)
2026-00016181	Welfare Concern	03/26/2026 12:03	CAVAN	Cibolo (2)
2026-00016470	Welfare Concern	03/27/2026 20:53	TERRAMAR	Cibolo (2)
2026-00012692	Welfare Concern	03/07/2026 19:54	DEAN RD	Guadalupe County

**CIBOLO
ANIMAL SERVICES**

MONTHLY REPORT

March 2026

TOTALS

INTAKES

Return/Owner Surrender	1
Seized/Custody	2
Stray	43
Transfer in	0
Wildlife In	11
TOTAL	57

OUTCOMES

Adoption	13	
Missing	0	
Deceased pick up	5	4 deceased possums and 1 deceased feline
Return to Owner	26	
Transfer Out	11	
Euthanasia	2	1 possum 1 squirrel
Wildlife Out	4	
TOTAL	61	

Transfer Out - Locations

Wildlife Rescue	1
Last Chance Forever Birds of Prey	0
Consevancy	0
Kirby Animal Services	0
Homes for Pets	2
The Animal Defense League	8
TOTAL	11



BITE CASES

Currently in Foster	4	(nursing cats w/ kittens)
----------------------------	----------	---------------------------

TOTAL NEW LICENSES ISSUED 9 (Does not count renewals)

VOLUNTEER HOURS 62.5h (plus 55.5h Communisty service)

LIVE RELEASE RATE FOR CATS/DOGS 100%



City Council Regular Meeting Staff Report

A. Discussion/Action on approval of the Niemietz Park and Veterans Memorial Park Master Plans and authorization for the City Manager to proceed with construction plan development. (Ms. Hernandez/Kimley-Horn).

Meeting	Agenda Group
Tuesday, April 14, 2026, 6:30 PM	Discussion/Action Item: 11A.
From	
Julio Gomez, Public Works Director	

PRIOR CITY COUNCIL ACTION

As part of the FY23–FY27 Five-Year Capital Improvement Program (CIP), City Council approved annual Parks funding of \$750,000 for fiscal years 2023 through 2026, and \$500,000 for fiscal year 2027 through 2030 to support improvements and reinvestment in the City’s park infrastructure.

During the April 5, 2025 Council Strategic Management Workshop, City Council reviewed park conditions, preliminary improvement cost estimates, and available funding. During that discussion, City Manager Wayne Reed, requested Council direction on the use of the previously allocated funding and which parks should be prioritized for improvements. City Council directed staff to move forward with renovations and improvements at Veterans Park and Niemietz Park.

BACKGROUND

On August 1, 2023, the City of Cibolo submitted an application to the Texas Parks and Wildlife Department Local Park Grant Program seeking \$1.5 million in grant funding for improvements to the Tolle Nature Preserve. The grant required a 50% local match, and \$750,000 was allocated in the FY24 budget to support the potential match.

In January 2024, the City was notified that it was not selected for the grant. The funding has remained allocated within the CIP pending City Council direction on how the funds should be utilized.

Following Council’s direction regarding park priorities, City staff met with three consultants under the City’s Master Service Agreements to discuss scope and approach for improvements at Veterans Park and Niemietz Park. After evaluating the firms’ experience and approach, Kimley-Horn was selected as the lead consultant for the park planning and design efforts.

As part of the planning process, Kimley-Horn led the community outreach efforts to gather public input on park amenities and improvements. A public input survey was available on the Cibolo Tomorrow page from June 6 through October 20, allowing residents to provide feedback on desired park improvements.

Additional feedback was gathered through public engagement activities, including Parks Commission dot exercises at Cibolo Summer Nights, the City Fishing Tournament, Splash Bash, and CiboloFest, as well as a Parks Commission pop-up event at Al Rich Park in July 2025.

A Town Hall meeting was held on November 5, 2025 during the Parks Commission meeting, providing residents an additional opportunity to review park concepts and provide feedback.

The outreach efforts helped identify community priorities for park amenities, improvements, and overall park experience, which guided development of the proposed master plans.

City staff presented the final renderings and cost estimates to the Parks Commission during the March 2026 Parks Commission meeting, and the Commission agreed with the concepts that are now being presented to City Council.

The proposed master plans include phased improvements at both parks, allowing the City to align construction with available funding. As presented to Council, Phase I focuses on critical infrastructure, ADA accessibility, and high-use amenities, with additional phases planned as funding becomes available.

For Veterans Memorial Park, Phase I includes parking improvements, restroom facilities, walking trails, and site infrastructure enhancements, with additional amenities planned in future phases.

For Niemietz Park, Phase I includes playground improvements, shade structures, pavilion renovations, parking, and trail connectivity, with additional amenities planned in future phases.

STAFF RECOMMENDATION

Staff recommends that City Council:

1. Approve the Master Plans for Veterans Memorial Park and Niemietz Park
2. Authorize the City Staff to proceed with Phase I construction plans for both parks, within available funding.

FINANCIAL IMPACT

The consultant services will be funded through the Parks funds allocated in the FY24–25 Capital Improvement Program (CIP).

Funding available for park improvements includes \$680,000 in FY24, \$700,000 in FY25, and \$750,000 in FY26, for a total of approximately \$2,130,000.

Staff anticipates that the Phase I construction plans and subsequent construction will be funded utilizing these available CIP funds.

MOTION(S)

I move to approve the Master Plans for Veterans Memorial Park and Niemietz Park and authorize the City Staff to proceed with Phase I construction plans within available funding.

Attachments

[Veterans Feedback.pdf](#)

[Niemietz Feedback.pdf](#)

[Public On-Line Survey.pdf](#)

[SMW Council Feedback.pdf](#)

[VET-NIEMIETZ-RENOVATION Presentation 4-14-26](#)



Veterans Memorial Park – Community Feedback on Improvements

Most Requested Improvements:

- **Shade** – Strongly emphasized as the top need, including shaded areas, covered play spaces, and general tree/structure shade.
- **Splash Pad/Water Feature** – Frequently requested by families as a new amenity.
- **Playground Enhancements** – Calls for larger, updated, and covered playground equipment.
- **Parking** – Additional parking and easier access are common concerns.
- **Landscaping/Grass** – Requests for improved turf and overall park aesthetics.
- **Sports Facilities** – Interest in soccer fields, basketball courts, pickleball, and fitness equipment.

Key Themes:

1. Comfort and usability during hot weather (shade, splash pad).
2. Family-friendly amenities (playgrounds, water features).
3. Infrastructure to support higher use (parking, turf).
4. Expanded recreation opportunities (sports courts and fields).

Summary:

The feedback highlights a clear demand for shaded areas, modernized playgrounds, and water play opportunities, along with practical upgrades such as more parking and improved landscaping. Sports and fitness facilities are also viewed as valuable additions.



Niemietz Park – Community Feedback on Improvements

Most Requested Improvements:

- **Playground Enhancements** – Strong consensus that the playground is outdated, unsafe, or too small. Requests for new equipment, better surfacing, swings, and updated design.
- **Shade** – Many comments call for shaded seating, covered play equipment, and shade along walking trails.
- **Restrooms** – Consistent mentions of the need for improved, cleaner, and more accessible restroom facilities.
- **Parking** – Multiple requests for expanded parking areas, safer access, and spaces closer to play areas.
- **Sports & Recreation Facilities** – Interest in pickleball courts, soccer practice space, ball fields, and better youth sports support.
- **Water Feature/Splash Pad** – Desire for a splash pad or water play area to make the park more family-friendly during hot weather.
- **Walking Trails & Open Space** – Improvements to trails with shade, benches, and safer connections.
- **General Maintenance & Upkeep** – Perceptions of the park being “old,” “outdated,” or “not maintained,” with calls for repainting, landscaping, and better year-round care.

Key Themes:

- **Modernization:** The park is widely seen as outdated and in need of new equipment and facilities.
- **Family Comfort:** Shade, restrooms, and safe play areas are top priorities for families.
- **Accessibility & Infrastructure:** Parking and restroom placement are critical to usability.
- **Expanded Recreation:** Requests for sports courts, splash pad, and enhanced open space point to a desire for more diverse recreation options.

Summary:

Community feedback clearly highlights Niemietz Park as a well-used but aging facility in need of major updates. Families prioritize a safer, modern playground, shaded areas, and better restrooms, while also calling for more parking and upkeep. Interest in water play and expanded sports facilities reflects a broader vision of the park as a vibrant, multi-use community destination.



Public Input – Online Survey

What facilities and amenities does your household utilize in Cibolo?

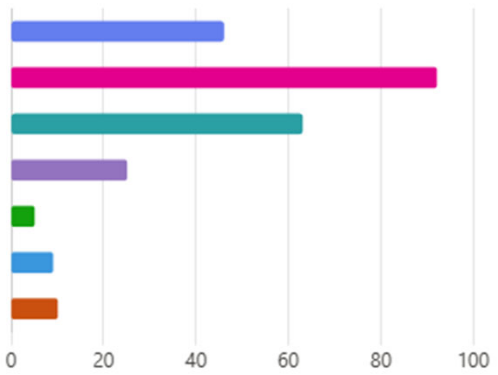

● Niemietz Park	46
● Veterans Memorial Park	92
● Schlather Park	63
● Cibolo Sports Complex	25
● Al Rich Park	5
● Cibolo Community Center	9
● Other	10

What was the main purpose for visiting Veterans Memorial Park?

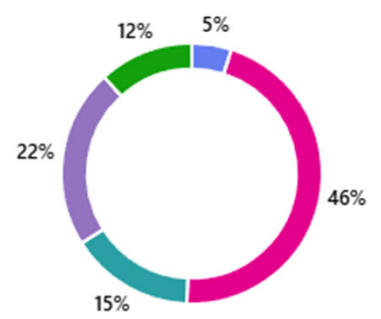

● Sports League	8
● Playground	74
● Walking Trails	25
● Open Spaces	36
● Other	19

How many times has your family visited Veterans Memorial Park in 2025?

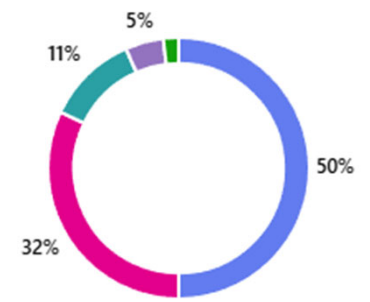

● 0-5 Times	53
● 6-12 Times	34
● 20-40 Times	12
● Weekly	5
● Daily	2



Public Input – Online Survey

How long have you lived in Cibolo?

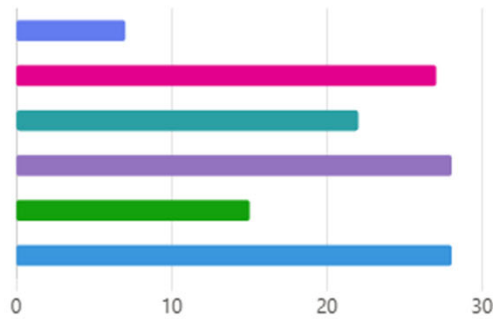

● Less than 1 year	7
● 1-3 Years	27
● 3-5 Years	22
● 5-10 Years	28
● 10-15 Years	15
● 15+ Years	28

What was the main purpose for visiting Niemietz Park?

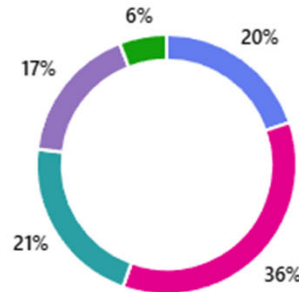

● Sports League	47
● Playground	85
● Walking Trails	51
● Open Spaces	41
● Other	14

How many times has your family visited Niemietz Park in 2025?

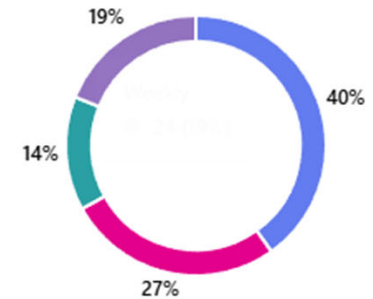

● 0-5 Times	51
● 6-12 Times	34
● 20-40 Times	18
● Weekly	24
● Daily	0



What does Council want to see with Parks

- Niemetz overhaul and upgrade field, more parking, Move the Parks Division storage for parking. Tolle Nature Park needs to get started ASAP. Town Creek Trail kick off.
- Better use of space w/ better family activities like Volleyball, Pickleball and basketball. Parking needs to be improve across the parks.
- Niemetz parks needs better parking. Veterans entrance sign needs to be updated and facelift. Al Rich baseball fields need improvement and sign update.
- Playground equipment upgrades (safety concern) at Veterans. Update playground at Niemetz. Schlather Park - Frisbie Golf to be improve (there is a group, in Cibolo, that has been asking to help). Field along Schaeffer road to be used for any sports fields.
- Hear from the people who ask about youth sports. Would like to see a solution for football options. Veterans should be priority and then focus on the newly purchased property near the bird sanctuary to focus on Football fields. Softball fields and baseball fields near sports complex.
- Improve parking across the parks, provide better activities and focus on beautification.
- Would like the Volleyball plan to be evaluated in the Parks Master Plan. Is it still the best use of the property at Schlather?

Voting

- **Top 2**
 - Niemetz Park
 - Veterans Park

Feedback

- See if EDC can help fund the Parks Master Plans and Trails Master Plan

Cibolo Parks City Council: Veterans Memorial and Niemietz Park Improvements



April 14, 2026



★ **Kimley»Horn**

Staff Recommendation

- **Staff recommends approval of the Master Plan for Veterans Memorial Park and Niemietz Park.**
- **Staff recommends proceeding with Phase I - Design Construction Plans for Veterans Memorial Park and Niemietz Park.**
- **Not to exceed available funding of \$2,130,000.00**



City Council Feedback And Direction

- **Does City Council approve the Master Plan for Veterans Memorial Park and Niemietz Park?**
- **Does City Council approve moving forward with the Phase I Design Construction Plan for Veterans Memorial Park and Niemietz Park, within available funding?**



Funding For Parks Improvements

	FY' 24	FY' 25	FY' 26
Parks	\$680,000.00	\$700,000.00	\$750,000.00

Parks	Veterans Memorial	Niemietz
	\$680,000.00	\$1,450,000.00



Project Scope and Objectives

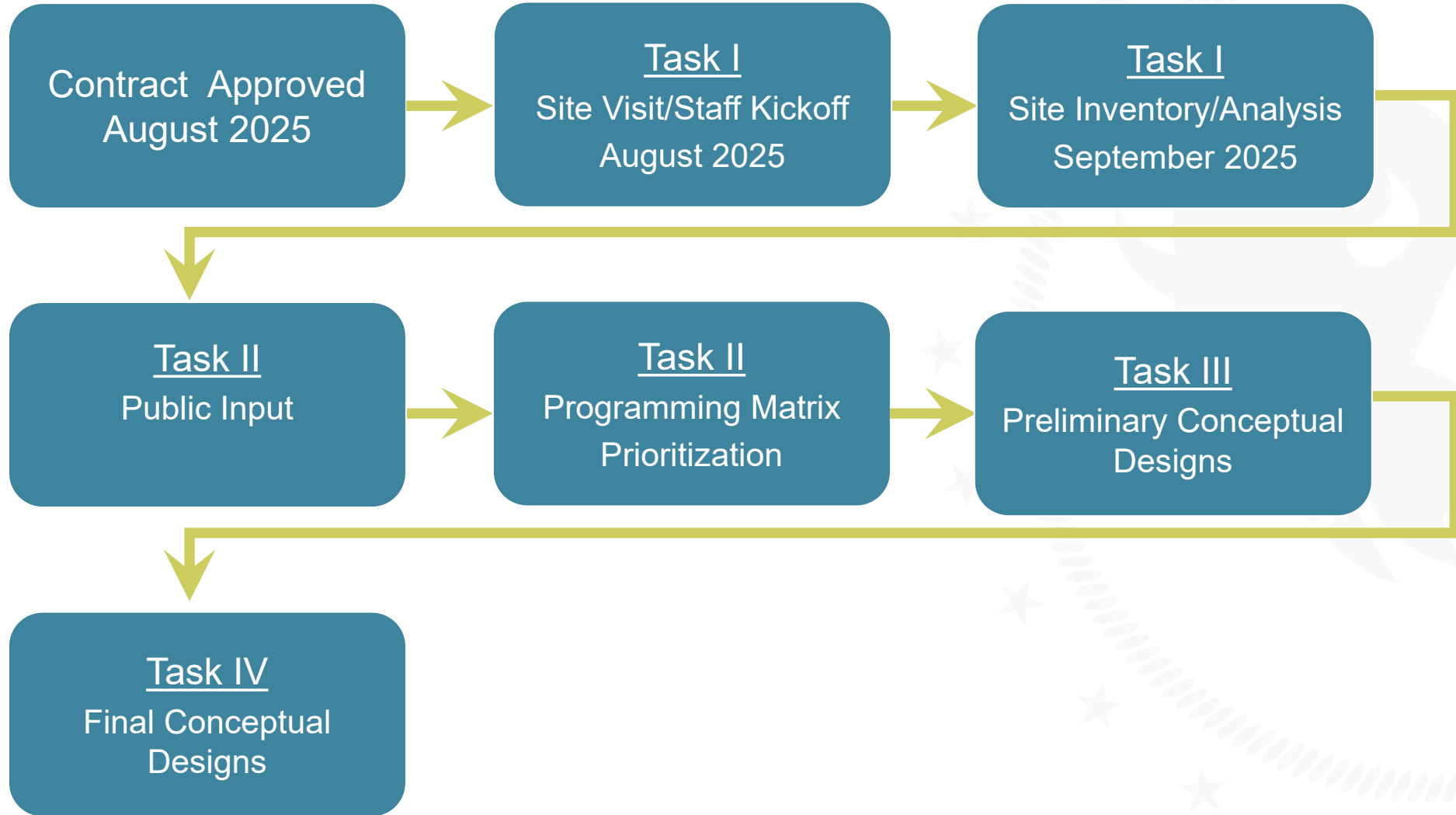

Veterans Memorial Park



Public Input Process

What facilities and amenities does your household utilize in Cibolo?

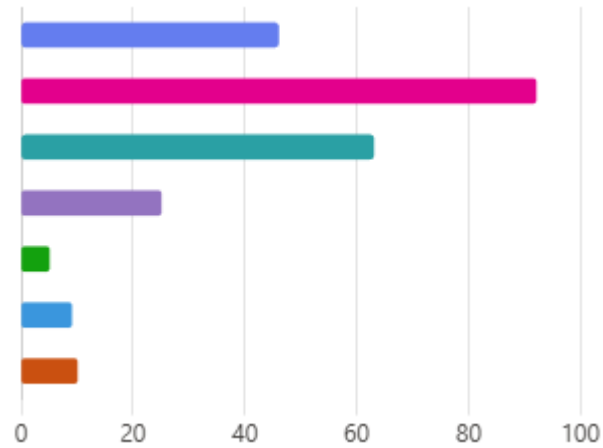

● Niemietz Park	46
● Veterans Memorial Park	92
● Schlather Park	63
● Cibolo Sports Complex	25
● Al Rich Park	5
● Cibolo Community Center	9
● Other	10

What was the main purpose for visiting Veterans Memorial Park?

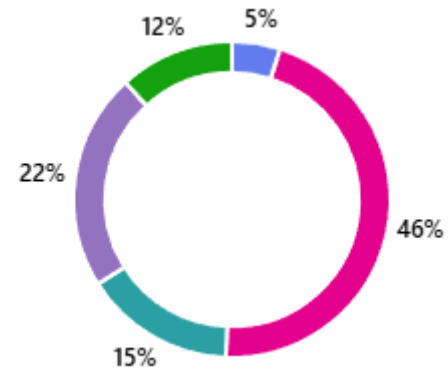

● Sports League	8
● Playground	74
● Walking Trails	25
● Open Spaces	36
● Other	19

How many times has your family visited Veterans Memorial Park in 2025?

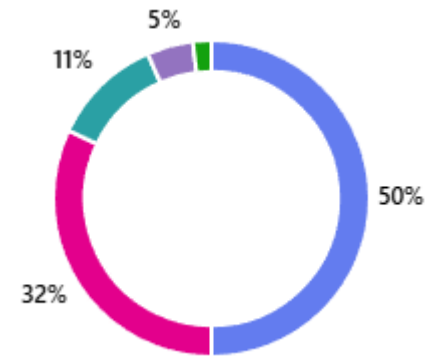

● 0-5 Times	53
● 6-12 Times	34
● 20-40 Times	12
● Weekly	5
● Daily	2



Propose Veterans Memorial Park Improvements



Site Information

Walking Trails

- +/- .25 Mile Walking Trail

Parking

- 29 Existing Stalls
- 23 Additional Proposed Stalls
- 52 Total Stalls (3 ADA)



Propose Veterans Memorial Park Improvements

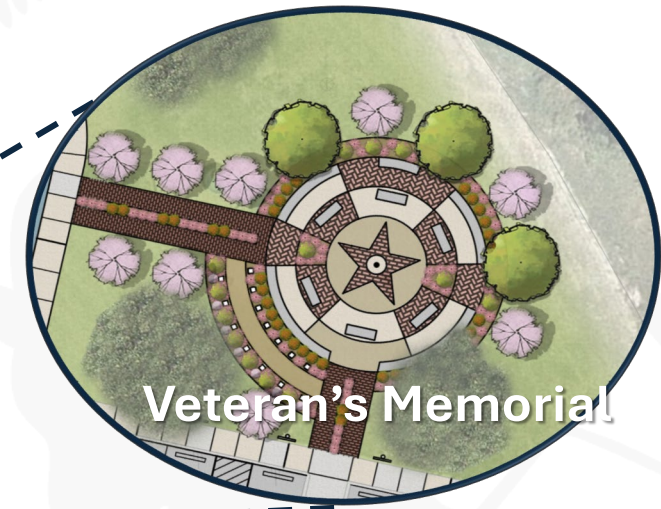
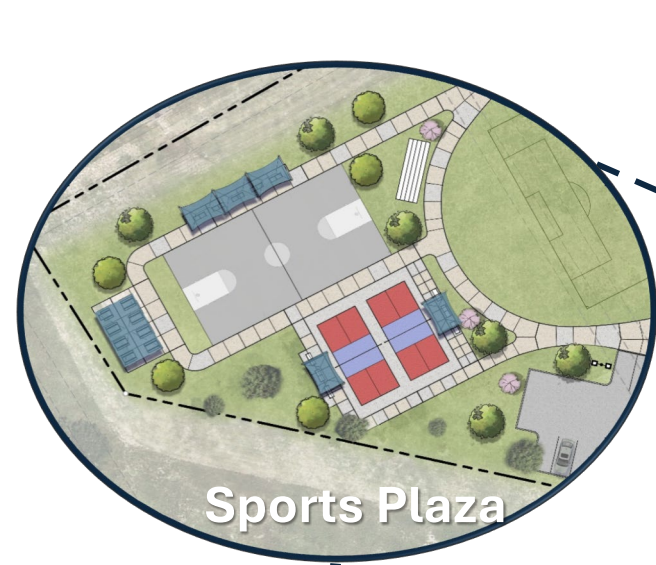

Veterans Memorial Park – OPC

Item	Item Cost
General Conditions +/- 8%	\$210,000.00
Grading, Site Preparation	\$300,000.00
General Onsite Utilities Allowance	\$200,000.00
Parking Lot Expansion Allowance	\$100,000.00
New Restroom Building	\$200,000.00
4" Concrete Trail	\$100,000.00
Field Landscape Allowance	\$100,000.00
Field Irrigation Allowance	\$100,000.00
Landscape Allowance	\$125,000.00
Irrigation Allowance	\$125,000.00
Veterans Memorial Allowance	\$150,000.00
Cantilever Shade Structures Allowance	\$100,000.00
Medium Playground Allowance	\$275,000.00
Site Lighting/Electrical Allowance	\$55,000.00
Site Furnishings (Benches, Picnic Tables) Allowance	\$80,000.00
20' X 30' Hip Shade Structure	\$75,000.00
Pickleball Courts	\$450,000.00
6" Concrete Sport Court Resurfacing	\$50,000.00
Contingency (10%)	\$260,000.00

Total Project Costs **\$3,055,000.00**



Veterans Memorial Park – Phase Map



-  Phase 1
-  Phase 2
-  Phase 3



Kimley»Horn

Veterans Memorial Park – Phase 1 OPC

Phase I

Item

Item Cost

General Conditions +/- 8%	\$100,000.00
Grading, Site Preparation	\$200,000.00
General Onsite Utilities Allowance	\$200,000.00
Parking Lot Allowance	\$100,000.00
New Restroom Building	\$200,000.00
4" Concrete Trail	\$100,000.00
Field Landscape Allowance	\$100,000.00
Field Irrigation Allowance	\$100,000.00
Landscape Allowance	\$125,000.00
Irrigation Allowance	\$125,000.00
Contitiency (10%)	\$135,000.00

Phase I Construction Cost

\$1,485,000.00



Veterans Memorial Park - Phase 1

Staff Recommendation For Base Bid And Add Alternate

Base Bid –

- Bathroom – ADA Compliance
- Parking Lot – Vehicular Circulation Improvement And ADA Compliance
- Concrete Sidewalk/Trails – ADA Compliance And Efficiency

Add Alternate –

- Field Landscape/Turf – Improve Usability
- Field Irrigation – Improve Field Turf
- Overall Landscaping In The Park – Improve Aesthetics
- Park Irrigation – To Water Proposed Landscaping Improvements



Niemietz Park



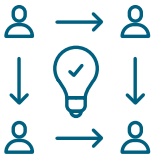

Public Input – Online Survey

How long have you lived in Cibolo?

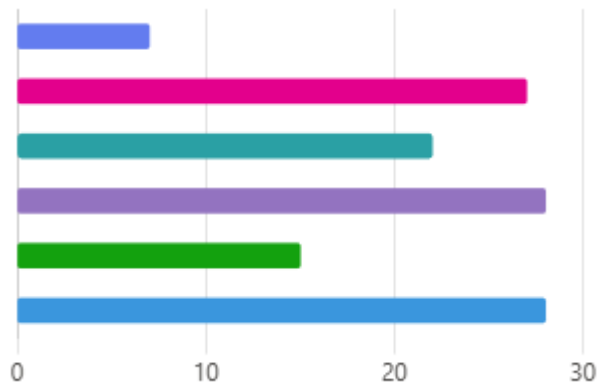

● Less than 1 year	7
● 1-3 Years	27
● 3-5 Years	22
● 5-10 Years	28
● 10-15 Years	15
● 15+ Years	28

What was the main purpose for visiting Niemietz Park?

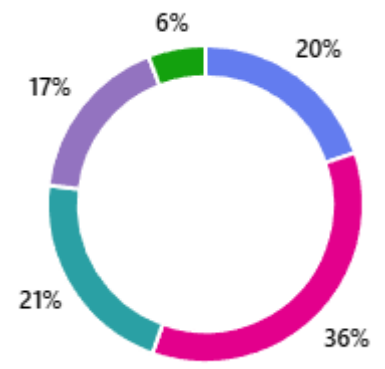

● Sports League	47
● Playground	85
● Walking Trails	51
● Open Spaces	41
● Other	14

How many times has your family visited Niemietz Park in 2025?

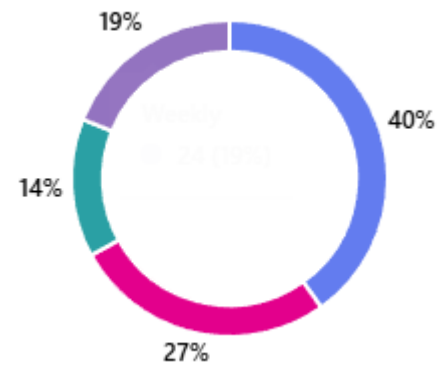

● 0-5 Times	51
● 6-12 Times	34
● 20-40 Times	18
● Weekly	24
● Daily	0



Propose Niemiets Park Improvements



Site Information

Walking Trails

- +/- .5 Mile Walking Trail

Parking

- 97 Existing Stalls
- 54 Proposed Stalls
- 151 Total Stalls (5 ADA)



Propose Niemietz Park Improvements

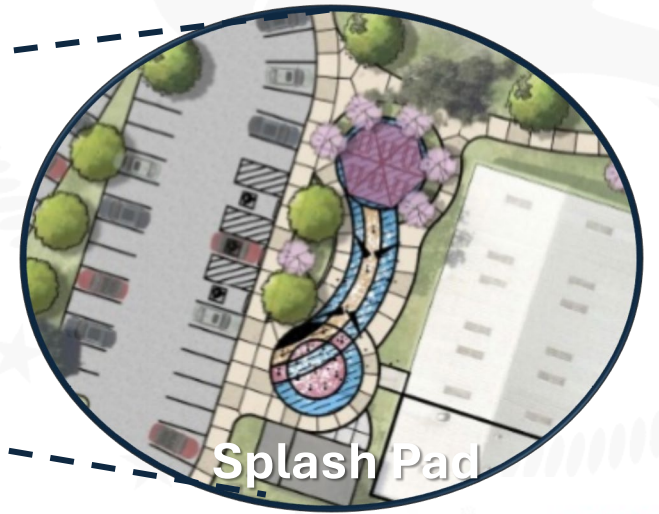

Niemietz Park – OPC

Item	Item Cost
General Conditions +/- 8%	\$350,000.00
Grading, Site Preparation	\$400,000.00
General Onsite Utilities Allowance	\$200,000.00
Large Playground Allowance	\$500,000.00
Playground Shade Structure Allowance	\$200,000.00
Parking Lot Allowance	\$600,000.00
Pavillion Restoration	\$500,000.00
4" Concrete Trail	\$275,000.00
Landscape Allowance	\$200,000.00
Irrigation Allowance	\$275,000.00
Restroom Buildings Remodel	\$100,000.00
Site Lighting/Electrical/Parking Lot Lighting Allowance	\$150,000.00
4" Concrete Trail	\$100,000.00
Outdoor Fitness Equipment Allowance	\$100,000.00
Decomposed Granite Trail	\$50,000.00
Football Field Reconstruction	\$75,000.00
Baseball Field Reconstruction	\$75,000.00
Site Furnishings (Benches, Picnic Tables) Allowance	\$100,000.00
Splashpad Allowance	\$450,000.00
Shade Structure Allowance	\$150,000.00
Contingency (10%)	\$450,000.00

Total Project Costs \$5,300,000.00



Niemietz Park– Phase Map



-  Phase 1
-  Phase 2
-  Phase 3



Niemietz Park – Phase 1 OPC

Phase I

Item

General Conditions +/- 8%

Grading, Site Preparation

General Onsite Utilities Allowance

Large Playground Allowance

Playground Shade Structure Allowance

Parking Lot Allowance

Pavillion Restoration

4" Concrete Trail

Restroom Building

Contingency

Item Cost

\$174,000.00

\$200,000.00

\$100,000.00

\$500,000.00

\$200,000.00

\$300,000.00

\$500,000.00

\$275,000.00

\$100,000.00

\$217,500.00

Phase I Construction Cost

\$2,566,500.00



Niemietz Park - Phase 1

Staff Recommendation For Base Bid And Add Alternate

Base Bid –

- Bathroom – ADA Compliance
- Large Playground – Improve Safety And Usability
- Playground Shade Structure – Improve Safety And Usability
- Pavilion Renovation – Improve Usability

Add Alternate –

- Parking Lot – Vehicular Circulation Improvement And ADA Compliance
- Concrete Sidewalk/Trails – ADA Compliance And Efficiency



Staff Recommendation

- **Staff recommends approval of the Master Plan for Veterans Memorial Park and Niemietz Park.**
- **Staff recommends proceeding with Phase I - Design Construction Plans for Veterans Memorial Park and Niemietz Park.**
- **Not to exceed available funding of \$2,130,000.00**



City Council Feedback And Direction

- **Does City Council approve the Master Plan for Veterans Memorial Park and Niemietz Park?**
- **Does City Council approve moving forward with the Phase I Construction Plan for Veterans Memorial Park and Niemietz Park, within available funding?**



Cibolo Parks City Council: Veterans Memorial and Niemietz Park Improvements



April 14, 2026



★ **Kimley»Horn**



City Council Regular Meeting Staff Report

B. Discussion/Action on approving funding for Old Town/Downtown lighting improvements (LED lantern toppers) as recommended by the Cibolo Economic Development Corporation (CEDC) (Mr. Hardin)

Meeting	Agenda Group
Tuesday, April 14, 2026, 6:30 PM	Discussion/Action Item: 11B.
From	
Clancy Hardin, Economic Development Manager	

PRIOR CITY COUNCIL ACTION:

N/A

BACKGROUND:

The Economic Development staff and the CEDC board are advancing safety and place making improvements in Old Town/Downtown Cibolo and previously brought forward an item related to funding Old Town lighting improvements during their February 19, 2026, regular meeting, which was tabled to allow staff to return with a proper vendor quote. This project will cover the area of Old Town/Downtown from Schlather Street to FM 78.

Economic Development, Planning, and Public Works staff are coordinating to improve safety and place making in Old Town/Downtown. Prior initiatives funded by the CEDC Board include the Old Town Study (FY25), downtown banner updates (FY25), a beacon crossing on Main Street near Old Main Ice House (FY26), and numerous BIG Grants to local businesses.

Staff received a quote from 2M Lighting Controls for Sigma-PLÉ Transitional LED Lantern fixtures/toppers intended to enhance roadway and sidewalk lighting while minimizing spill back toward nearby housing.

Maintenance Note: LED components are described as low-maintenance; no bulbs, with typical driver/LED board lifespan noted at 5–10 years. Once installed the care and maintenance will be the responsibility of the Public Works Department.

STAFF RECOMMENDATION:

Staff recommends approval to proceed with the Old Town/Downtown lighting improvements for safety enhancements in Old Town/Downtown Cibolo, consistent with the CEDC’s approval/recommendation during their March 19, 2026 meeting.

FINANCIAL IMPACT:

Materials: \$37,327.50 one-time cost (approximately \$1,777.50 each) for 21 toppers/fixtures.

The vendor is a buyboard vendor. Funding is supported by the Cibolo EDC Type B funds in the existing budget.

MOTION(S):

Suggested motion: I move to approve funding the Old Town/Downtown lighting project as recommended by the CEDC Board and staff in the not to exceed amount of \$40,000 provided invoices are verified and coordinate with Public Works for installation.

Attachments

[Old Town Cibolo Lighting Project.pdf](#)



2M Lighting + Controls
 204 E Rhapsody Dr, San Antonio, TX
 San Antonio TX 78216
 Phone: (210) 599-4040

Project Cibolo Main St. Post Tops
Location Cibolo TX
Quote 2M26-41698-1

From: Spencer Canarina
Quoter Ph:
Email: Spencer@2meli.com

To:
 FSG LIGHTING
 3003 NE LOOP 410 STE. 130
 SAN ANTONIO TX 78218
 Phone: (210) 657-5025

For
Bid Date Feb 26, 2026
Expires Mar 28, 2026

QTY	Type	MFG	Part
21		USAL/SVL	SIG23/PLED-III-W/48LED-875MA/30K/120/PT23/RAL-9005-T/PC120

Total: \$37,327.50

Terms and conditions of sale:

** ALL QUOTES ARE SUBJECT TO FINAL APPROVAL UNLESS OTHERWISE NOTED ABOVE, OR 2M IS SPECIFIED ON THE FIXTURE SCHEDULE. PRICE IS SUBJECT TO CHANGE PENDING APPROVAL FOR LINES 2M IS NOT SPECIFIED ON **

SPARES ARE NOT INCLUDED ON THIS QUOTE UNLESS LISTED ON THE CONTRACTOR'S BILL OF MATERIAL (BOM) AND NOTED ON THE QUOTE ABOVE. IT IS THE RESPONSIBILITY OF THE CONTRACTOR TO PROVIDE THE REQUIRED INFORMATION IN ORDER TO PROPERLY QUOTE THE SPARES NEEDED. (THIS MUST BE INCLUDED ON THE CONTRACTOR'S BILL OF MATERIAL (BOM) OR WILL NOT BE INCLUDED IN THE QUOTE ABOVE.) ONE LOT OF SPARES WILL NOT BE ACCEPTABLE.

**IF SPARES ARE NEEDED AND ARE NOT LISTED ABOVE, ADD 5% TO THE TOTAL QUOTED PRICE **

**This quotation is valid for 30 days. After that period, 2M Lighting reserves the right to requote the above project due to possible price changes for provided manufacturers' products. 2M Lighting also reserves the right to void this quotation at any time.

TAXES ARE NOT INCLUDED

**2M Lighting, Inc. takes no responsibility in reviewing and/or correcting the contractor's Bill of Material (BOM). It is the responsibility of the contractor to provide dimensions for all linear fixture runs and patterns; any change made to these dimensions or quantities after the initial bid is subject to a price increase/decrease.

**A Purchase order or "Hold for Release PO" is required for all factory drawings; Lead times for drawings will vary, depending on workload and/or size of the job. Therefore, it is the contractor and/or electrical distributor's responsibility to provide sufficient time for the factory to create and issue these drawings; Expediting fees may apply.

**Distributor rebate incentives are not included in this quotation.

**Distributor storage and handling fees are not included in this quotation.

**Mark-up for Minority Contractor projects is not included in this quotation unless noted on the above quote.



2M Lighting + Controls
204 E Rhapsody Dr, San Antonio, TX
San Antonio TX 78216
Phone: (210) 599-4040

Project Cibolo Main St. Post Tops
Location Cibolo TX
Quote 2M26-41698-1

From: Spencer Canarina
Quoter Ph:
Email: Spencer@2meli.com

**Allowances are not provided in the quote above unless noted. It is the responsibility of the contractor to carry any required allowances.

**Any modification or change required to the above quoted project will be subject to a requotation. This quotation is only valid for the quantities listed on the above project. Any deviation from or modification of the above quoted quantities will require a requote.

**Any requotation of a project voids all previous quotes provided by 2M Lighting for said project.

**2M Lighting is not responsible for any errors in counts or Bills of Material provided to us for projects. All quotations by 2M Lighting not using specified or approved equal products are to be considered subject to approval by the purchasing party.

**All quotes are "plus freight" unless otherwise specified.

**All fixtures are quoted with standard finishes unless noted. Any fixture finishes unspecified at the time of quotation will be considered standard and quoted as such. If a custom color is later desired, additional charges may apply and will require a requote.

**All fixtures are quoted with standard mounting hardware unless noted. Any fixture with an unspecified mounting style at the time of quotation will be considered standard and quoted as such. If a mounting style requiring additional hardware is later desired, additional charges may apply and will require a requote.

**All quotations by 2M Lighting are subject to the quoted manufacturers' published terms and conditions.

**Any estimated delivery dates or lead times provided are for guidance purposes only and are subject to change.

**All orders from this quotation are binding and non-refundable. Any cancellation or modification to an order will be at the sole discretion of 2M Lighting and may be subject to a restocking fee.

**All quoted items are not considered Buy American, Buy America, or ARRA compliant unless otherwise specified.

LIGHTING CONTROLS TERMS:

**Startup included in any quotations, whether by factory or by 2M, is quoted as ONE trip to the job site for any applicable programming, startup and/or training unless otherwise noted on the bill of materials.

**Startup should be requested at least three weeks in advance to allow for scheduling and project review by factory or 2M. 2M and partner manufacturers will strive to perform startups as quickly as possible but startup requests that are less than three weeks out may be pushed out to later dates depending on availability.

**System commissioning required by IECC is not included in this quote and is assumed to be provided by the architect, engineer or an authorized certified commissioning agent.

**Custom engraving of wall stations/switches/other devices is not included in this quote unless explicitly noted in a

Date: Feb 26, 2026

Quote: 2M26-41698-1

Quote

Page 3/3



2M Lighting + Controls
204 E Rhapsody Dr, San Antonio, TX
San Antonio TX 78216
Phone: (210) 599-4040

Project Cibolo Main St. Post Tops
Location Cibolo TX
Quote 2M26-41698-1

From: Spencer Canarina
Quoter Ph:
Email: Spencer@2meli.com

line item on the bill of materials. Custom engraving could result in additional costs and lead times if needed. If custom engraving is required, please contact 2M Lighting to obtain the necessary custom engraving paperwork Ste

AREA & ROADWAY LIGHTING

PROJECT NAME: _____

SIGMA® - PLED TRANSITIONAL LED LANTERN

PROJECT TYPE: _____

Luminaire

Cast Aluminum Struts and Housing are heavy wall, low copper aluminum alloy (A356 alloy, <0.2% copper). Traditional styling of the housing provided with hinged top for easy access.

PLED™ Optics

Emitters (LED's) are arrayed on a metal core PCB panel with each emitter located on a copper thermal transfer pad and enclosed by an LED refractor. LED optics completely seal each individual emitter to meet an IP66 rating. In asymmetric distributions, a micro-reflector inside the refractor re-directs the house side emitter output towards the street side, maximizing usable light. Optional house side shields are available that cover each individual optic. Refractors are injection molded H12 acrylic. Each LED refractor is sealed to the PCB over an emitter and all refractors are retained by an aluminum frame. Any one Panel, or group of Panels in a luminaire, have the same optical pattern. LED refractors produce standard site/area distributions. Panels are field replaceable and field rotatable in 90° increments. Quick-disconnects are provided above each panel for fast field replacement. All fixture optical options will provide a "U0" no uplight optical package and is are dark sky friendly.

Ambience Low Luminance Lens

Optional Ambience Lens (AL) provides low luminance reduced glare distributions. Lens diffuses the PLED Optics and provides a more uniform luminance across the aperture reducing glare at all angles. Lens is provided with an aluminum frame and is sealed to the housing with high temp gasketing.

LED Emitters

High Power White LED's are driven between 350mA and 875mA for a maximum output of 2.5 Watts nominal. LED's are available in standard Neutral White (4000K), Cool White (5000K), or Warm White (2700K & 3000K). All Standard LED's have a minimum of 70 CRI. Consult Factory for other LED options. Lumen Maintenance of L94 at 60,000 hours (TM-21 calculated at 6x Test Time).

True Amber LED's TRA-True Amber LED's emit light in the amber spectral bandwidth centered on 585-590nm. True Amber has negligible blue light and is suitable for wildlife.

LED Driver

Constant current electronic with a power factor of >.90 and a minimum operating temperature of -40°F/-40°C. Driver(s) is/are UL and cUL recognized. In-line terminal blocks facilitate wiring between the driver and optical arrays. Drivers accept an input of 120-277V, 50/60Hz or 347V-480V, 50,60Hz. (0 - 10V dimmable driver is standard. Driver has a minimum of 3KV internal surge protection. Luminaire supplied with 20KV surge protector for field installation.)

Finish

Polyester powder coat incorporates four step iron phosphate process to pretreat metal surface for maximum adhesion. Top coat is baked at 400°F for maximum hardness and exterior durability.

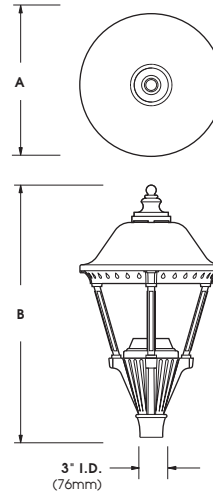

SIG-T

(SIG23 shown)

Fitter supplied to fit over 2 7/8" X 3" (73mm X 76mm) fennon.

Fixture	A	B
SIG23-T	23.5" 597mm	41.75" 1060mm
SIG18-T	18.5" 470mm	32" 813mm

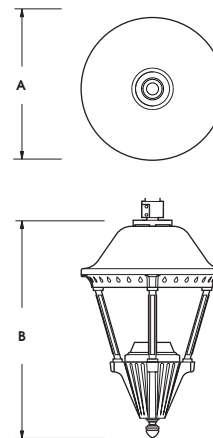

SIG-P

(SIG23 Pendant Mount shown)

Fixture	A	B
SIG23-P	23.5" 597mm	35.5" 911mm
SIG18-P	18.5" 470mm	27.5" 696mm



2023101

SIG SERIES - PLED

PRODUCT CONFIGURATIONS

EPA & WEIGHT

No Lens

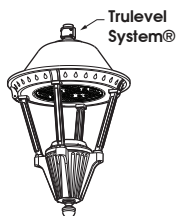

SIG23-P
Max Weight = 56 lbs
Max EPA = 1.74
48 LED Max



SIG23T
Max Weight = 57 lbs
Max EPA = 1.83
48 LED Max

w/ Ambience Low Luminance Lens

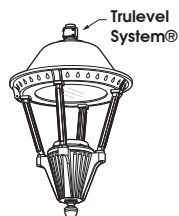

SIG23-P-AL
Max Weight = 56 lbs
Max EPA = 1.74
48 LED Max



SIG23-T-AL
Max Weight = 57 lbs
Max EPA = 1.83
48 LED Max



SIG18-P
Max Weight = 28 lbs
Max EPA = 1.08
36 LED Max



SIG18-P
Max Weight = 28.5 lbs
Max EPA = 1.14
36 LED Max



SIG18-P-AL
Max Weight = 28 lbs
Max EPA = 1.08
36 LED Max



SIG18-P-AL
Max Weight = 28.5 lbs
Max EPA = 1.14
36 LED Max

SIG SERIES - PLED

PLED™ MODULES

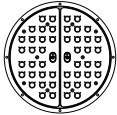

48 LED Module





















36 LED Module



20 LED Module

ORDERING INFORMATION

Spec/Order Example: SIG18-P/PLED-III/20LED-525mA/40K/240/PM-WM/RAL-6005-S/NL

Luminaire	Optics	LED Mode			Voltage	Mounting	Finish	Options
Luminaire	Optics	LED			Voltage	Mounting	Finish	Options
Tenon Mount: <input type="checkbox"/> SIG23-T <input type="checkbox"/> SIG18-T Pendant Mount: <input type="checkbox"/> SIG23-P <input type="checkbox"/> SIG18-P	PLED™ Distribution Type For NL Options: <input type="checkbox"/> PLED-II  <input type="checkbox"/> PLED-II-FR  <input type="checkbox"/> PLED-III  <input type="checkbox"/> PLED-III-W  <input type="checkbox"/> PLED-IV  <input type="checkbox"/> PLED-IV-FT  <input type="checkbox"/> PLED-V-SQ-N  <input type="checkbox"/> PLED-V-SQ-M  <input type="checkbox"/> PLED-V-SQ-W  Ambience™ Lens Option ³ : <input type="checkbox"/> AL-ASY <input type="checkbox"/> AL-ASY-HS <input type="checkbox"/> AL-SYM	# of LEDs <input type="checkbox"/> 48LED ¹ <input type="checkbox"/> 36LED <input type="checkbox"/> 20LED	Drive Current <input type="checkbox"/> 875mA <input type="checkbox"/> 700mA <input type="checkbox"/> 525mA <input type="checkbox"/> 350mA <input type="checkbox"/> 175mA	Color Temp - CCT <input type="checkbox"/> 27K (2700K) <input type="checkbox"/> 30K (3000K) <input type="checkbox"/> 40K (4000K) <input type="checkbox"/> 50K (5000K) <input type="checkbox"/> TRA True Amber ²	<input type="checkbox"/> 120 <input type="checkbox"/> 208 <input type="checkbox"/> 240 <input type="checkbox"/> 277 <input type="checkbox"/> 347 <input type="checkbox"/> 480	Post Top <input type="checkbox"/> PT23  (To fit 2 3/8" O.D.) <input type="checkbox"/> PT27  (To fit 2 7/8" O.D.) Pendant Mount <input type="checkbox"/> PM  Arm Mount <input type="checkbox"/> 1  <input type="checkbox"/> 2-180  <input type="checkbox"/> 2-90  <input type="checkbox"/> 3-90  <input type="checkbox"/> 3-120  <input type="checkbox"/> 4-90  Wall Mount <input type="checkbox"/> WM 	Standard Textured Finish <input type="checkbox"/> Black RAL-9005-T <input type="checkbox"/> White RAL-9003-T <input type="checkbox"/> Grey RAL-7004-T <input type="checkbox"/> Dark Bronze RAL-8019-T <input type="checkbox"/> Green RAL-6005-T Premium Finishes <input type="checkbox"/> Rust <input type="checkbox"/> Patina Copper PC For smooth finish replace suffix "T" with suffix "S" (Example: RAL-9500-S) Consult factor for custom colors	<input type="checkbox"/> Catenary Mount (Cable Box/Clamp Bracket) CCB <input type="checkbox"/> Stem Mount + Length(in) (48" Max) SM+L <input type="checkbox"/> Chain Mount + Length(in) (48" Max) CM+L <input type="checkbox"/> Internal House Side Shield incl. LED Count (Example: HS-PLED/48) HS-PLED <input type="checkbox"/> Twist Lock Receptable Only TPR <input type="checkbox"/> 7-Pin Twist Lock Receptable Only TPR7 <input type="checkbox"/> High-Low Dimming for Switch by Others/Select Levels 50/100 or 25/100 (Example: HLSW/25) HLSW <input type="checkbox"/> Twist Lock Photocell + Voltage (Example: TPC347V) TPC+V <input type="checkbox"/> Photocell + Voltage (Example: PC120V) PC+V <input type="checkbox"/> Single Fuse (Example: DF277V) SF+V <input type="checkbox"/> Double Fuse (Example: DF240V) DF+V <input type="checkbox"/> Blue-Tooth Programmable Photo/Motion Sensor (Factory - Motion 50/100; Photo 75(c)) MS-F311

SIG SERIES - PLED

SAMPLE ASSEMBLIES

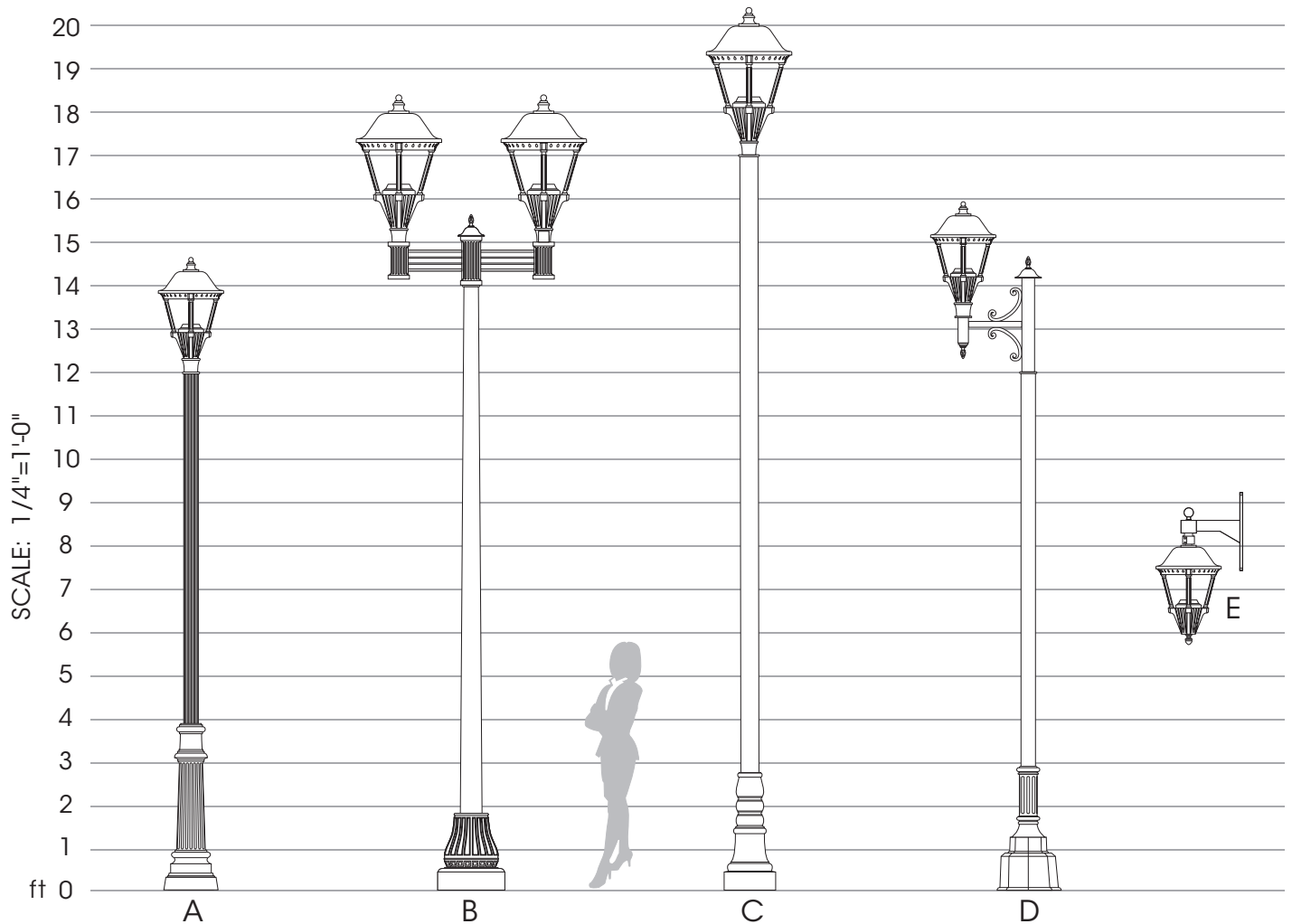

- A. 54-CBC-1060-12'/PT/SIG18/LED/ACCESSORIES/FINISH
- B. 17M-1046T-14'/XAX-2-180/SIG23/LED/ACCESSORIES/FINISH
- C. 40SB-1050-17'/PT/SIG23/LED/ACCESSORIES/FINISH
- D. 51-1040-12'/XAE-1/SIG18/LED/ACCESSORIES/FINISH
- E. WM-XBY-PM/SIG18/LED/ACCESSORIES/FINISH

Sample Assemblies show a small offering of the Sun Valley Line of Poles, Bases, Shafts, Arms, & Luminaires. Please visit usalitg.com for the full product offering.

SIG SERIES - PLED

OPTIONS

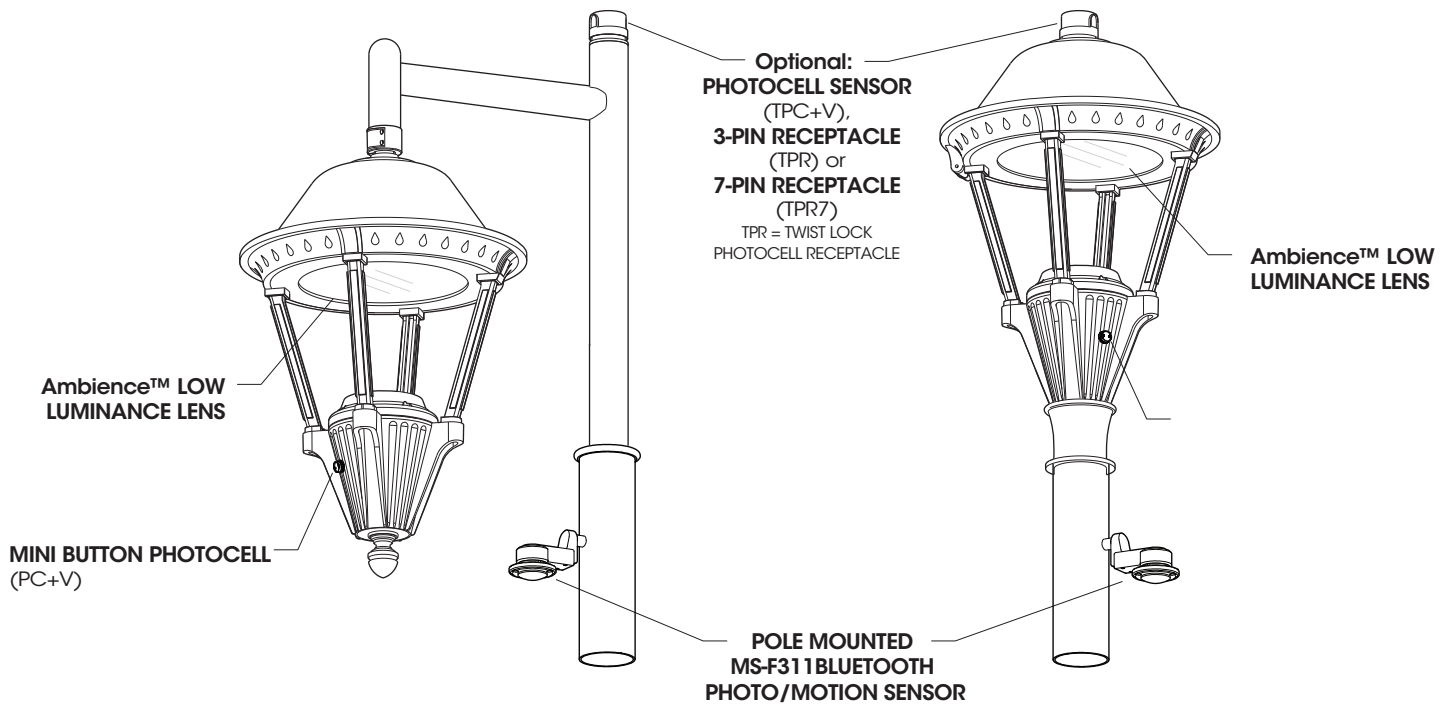

Factory Settings:
No Motion - 50%
Motion - 100%
Delay - 15 min.
Photocell - 75fc

Sensors can be Field
Programmed With
Bluetooth App

Coupling Provided
on Pole to Secure
Motion Sensor.

High Low Dimming For Switches (HLSW)

The HLSW is a Small Electronic Switch which Provides High Low Dimming Control Through the LED Driver's 0-10V Control. Switching is Done by Adding a Secondary AC Switched Hot Trigger Line to the HLSW in Addition to the Normal AC Power Line. When the Secondary Trigger Line is Powered, the Fixture will go to 100% Dimming. With no Power to the Trigger, the Fixture will operate at 50% or 25% Dimming. Switches for the Trigger Line can be a Normal AC Switch/Breaker or Timed Switch/Breaker.

Wireless and Other Fixture Controls

Contact Factory for Wireless and Other Fixture Controls and Recommendations. Most Controls Can be Integrated and Factory Installed.

SIG SERIES - PLED

INSTALLATION DETAIL

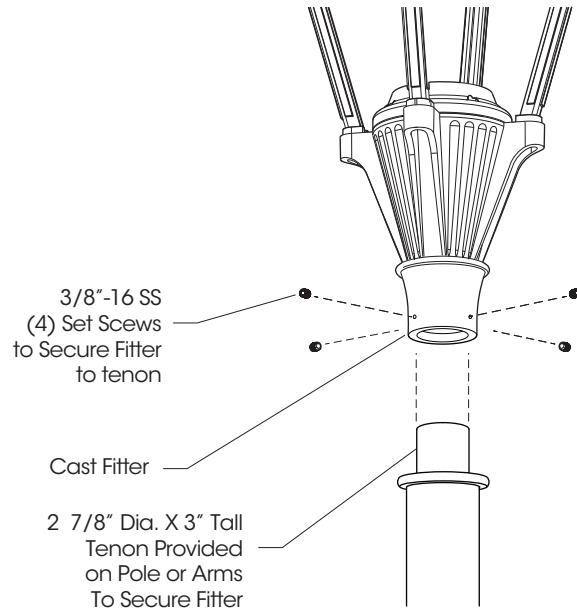

SIG Post Top Installation

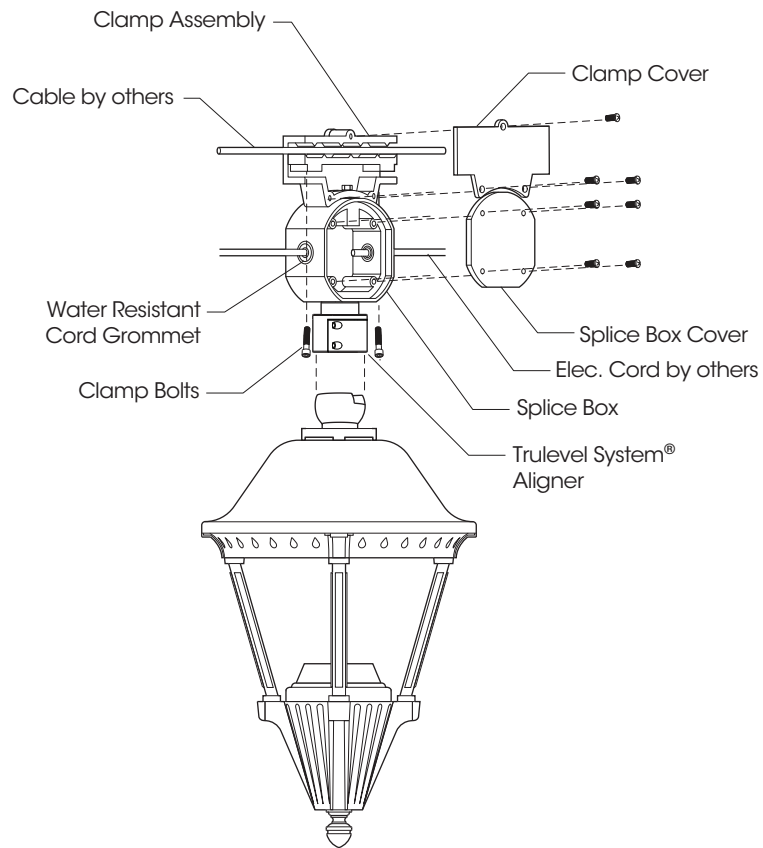

SIG Catenary Installation

SIG SERIES - PLED

Trulevel System® Assembly

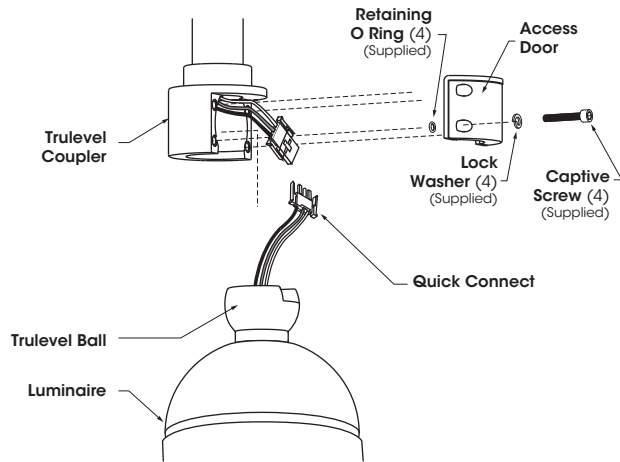

1. Loosen (4) Captive Screws and remove Access Door from Trulevel Coupler, pull out Quick Connect from Trulevel Coupler and Trulevel Ball.

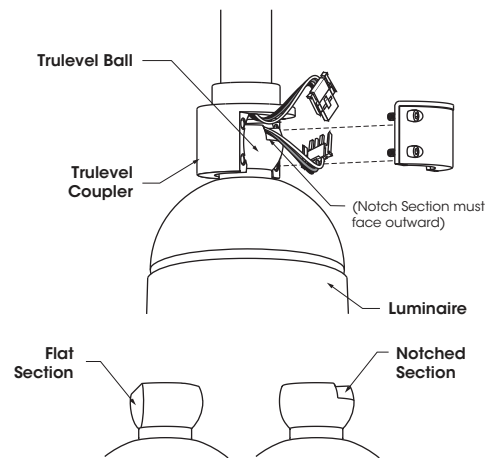

2. Place Trulevel Ball inside of Trulevel Coupler as illustrated.
 - A - Notched Section of Trulevel Ball must face outward as illustrated.
 - B - Flat Section of Trulevel Ball must face inward.

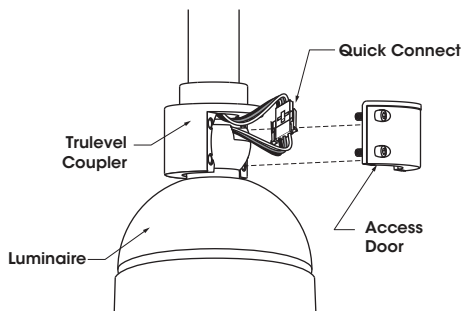

3. Connect Quick Connect components, push components inside of Trulevel Coupler cavity, replace Access Door and loosely secure, do not tighten.

Fixture will suspend without Access Door during installation.

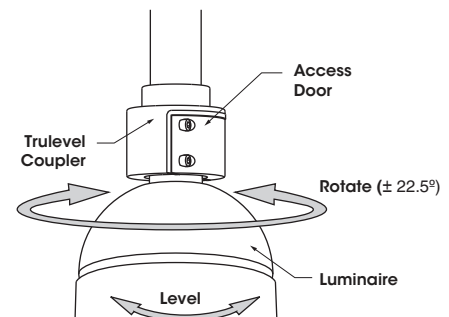

4. Rotate (left to right $\pm 22.5^\circ$) and level Luminaire to desired position. Tighten Access Door.

(Tighten each bolt to recommended torque: **10 ft-lb, foot-pound**)

Trulevel Pendant Mount is intended to allow for fixture leveling, but is not intended to be "free-swinging" upon proper installation.

SIG SERIES - LED

ELECTRICAL DATA GUIDE - AMPERAGE CHART

LED System			CURRENT (A)				
# of LEDs	mA	System Watts	120V	208V	277V	347V	480V
20	175	11.0	0.09	0.05	0.04	0.03	0.02
20	350	22.0	0.18	0.11	0.08	0.06	0.05
20	525	33.0	0.28	0.16	0.12	0.10	0.07
20	700	44.0	0.37	0.21	0.16	0.13	0.09
20	875	55.0	0.46	0.26	0.20	0.16	0.11
36	175	19.8	0.17	0.10	0.07	0.06	0.04
36	350	39.6	0.33	0.19	0.14	0.11	0.08
36	525	59.4	0.50	0.29	0.21	0.17	0.12
36	700	79.2	0.66	0.38	0.29	0.23	0.17
36	875	99.0	0.83	0.48	0.36	0.29	0.21
48	175	26.4	0.22	0.13	0.10	0.08	0.06
48	350	52.8	0.44	0.25	0.19	0.15	0.11
48	525	79.2	0.66	0.38	0.29	0.23	0.17
48	700	105.6	0.88	0.51	0.38	0.30	0.22
48	875	132.0	1.10	0.63	0.48	0.38	0.28

PHOTOMETRIC DATA GUIDE - LM-80 LUMEN MAINTENANCE

LED Life / Operating Hours	Lumen Depreciation	Lumen Depreciation Scale Factor
60,000 (10x Test Time Calculated)	L94	0.94x
100,000 (Theoretical Calculated)	L92	0.92x
150,000 (Theoretical Calculated)	L89	0.89x

Lumen Depreciation Calculations Done in Accordance With IESNA TM-21 & LM-80 (25°C Ambient)

TM-21 6x Test Time Dictates that L94 > 60,000 Hours.

SIG SERIES - LED

PHOTOMETRIC DATA GUIDE - ISOFOOTCANDLE TEMPLATES

SIG18-PLED-36LED-700mA-40K - 16' Height (14' Pole)

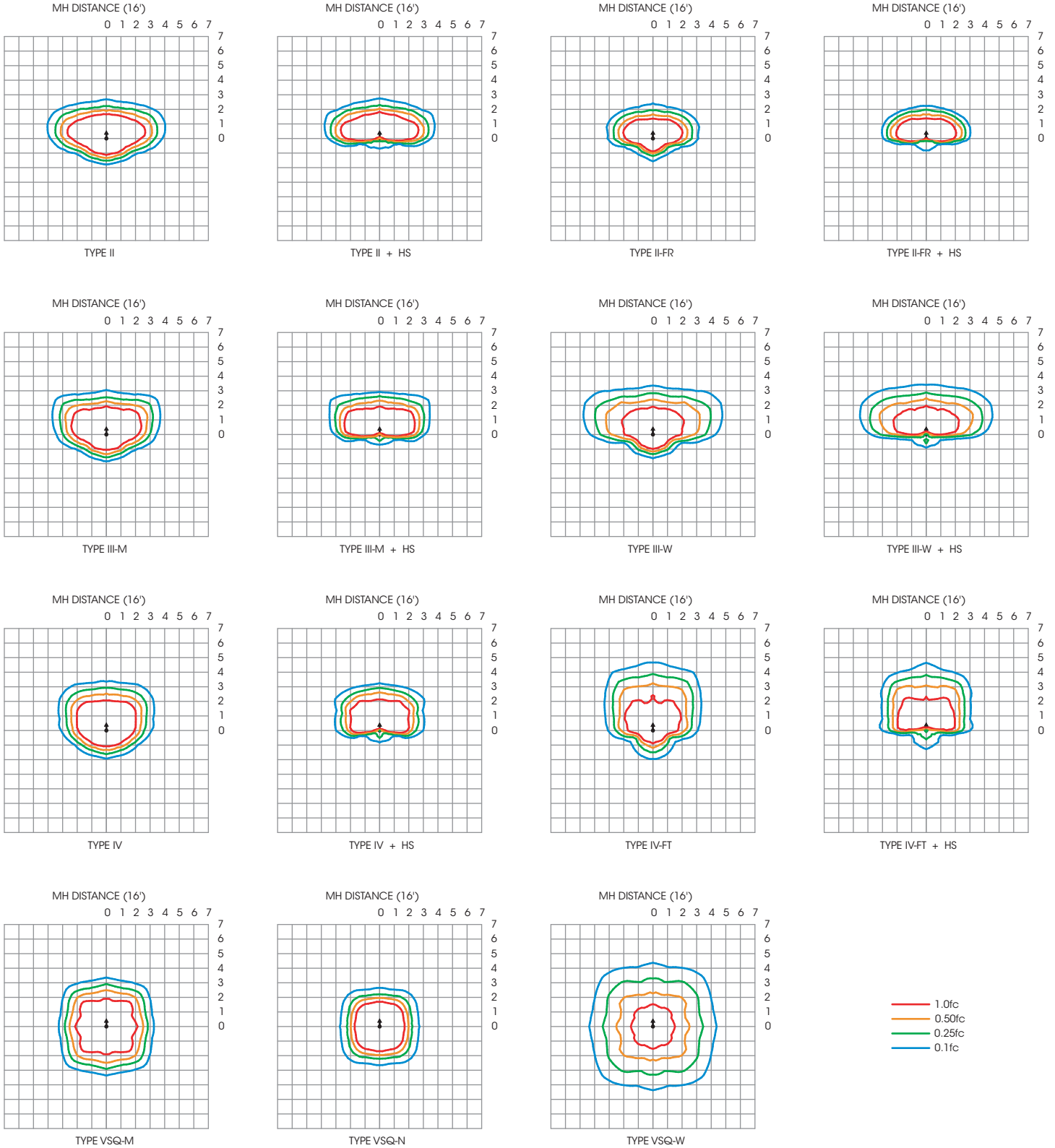

IES File downloads for this product can be found at www.usaltg.com/downloads/asr.html

SIG SERIES - LED

PHOTOMETRIC DATA GUIDE - ISOFOOTCANDLE TEMPLATES

SIG23-PLED-48LED-875mA-40K - 20' Height (18' Pole)

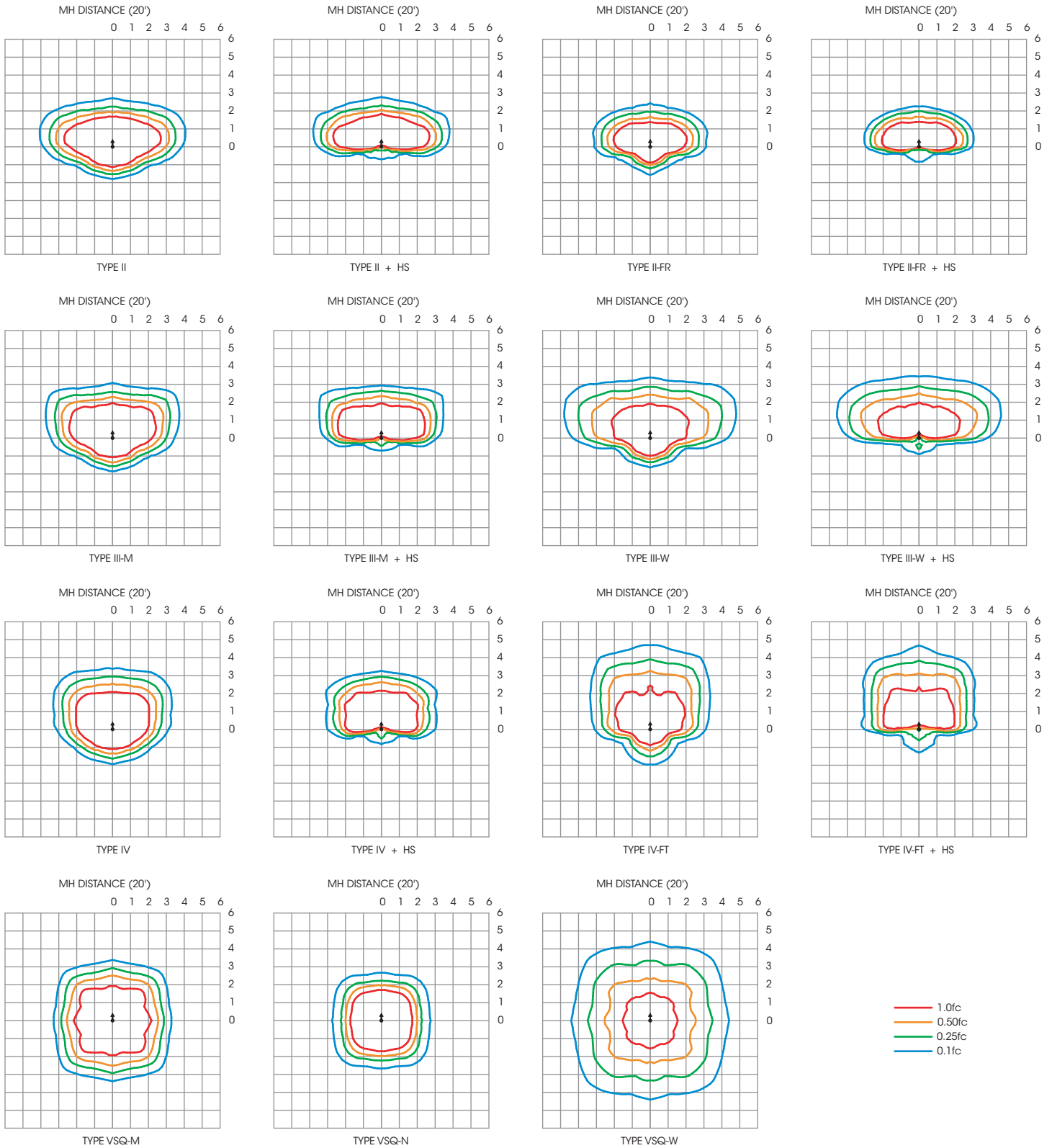

IES File downloads for this product can be found at www.usaltg.com/downloads/asr.html

SIG SERIES - LED

PHOTOMETRIC DATA GUIDE - LUMEN TABLES (SIG18-PLED)

SIG18-PLED																			
LED Count	Drive Current (mA)	System Watts	Dist'n Type	27K (2700K - 70CRI)			30K (3000K - 70CRI)			40K (4000K - 70CRI)			50K (5000K - 70CRI)			System Watts	TRA (590nm)		
				LUMENS	LPW	BUG RATING	LUMENS	LPW	BUG RATING	LUMENS	LPW	BUG RATING	LUMENS	LPW	BUG RATING		LUMENS	LPW	BUG RATING
20	175	11.0	II	1189	108	B1-U0-G0	1284	117	B1-U0-G0	1351	123	B1-U0-G0	1419	129	B1-U0-G1	9.0	441	49	B0-U0-G0
			II-FR	1148	104	B0-U0-G0	1239	113	B0-U0-G0	1305	119	B0-U0-G0	1370	125	B0-U0-G0		425	47	B0-U0-G0
			III-M	1216	111	B0-U0-G0	1313	119	B1-U0-G0	1382	126	B1-U0-G0	1451	132	B1-U0-G1		451	50	B0-U0-G0
			III-W	1125	102	B0-U0-G1	1214	110	B0-U0-G1	1278	116	B0-U0-G1	1342	122	B0-U0-G1		417	46	B0-U0-G0
			IV	1224	111	B0-U0-G0	1321	120	B1-U0-G0	1391	126	B1-U0-G1	1460	133	B1-U0-G1		453	50	B0-U0-G0
			IV-FT	1089	99	B0-U0-G1	1176	107	B0-U0-G1	1238	113	B0-U0-G1	1299	118	B0-U0-G1		404	45	B0-U0-G1
			VSQ-N	1261	115	B1-U0-G0	1361	124	B1-U0-G0	1433	130	B1-U0-G0	1504	137	B1-U0-G0		467	52	B0-U0-G0
			VSQ-M	1273	116	B1-U0-G0	1374	125	B1-U0-G0	1447	132	B1-U0-G0	1519	138	B1-U0-G0		472	52	B1-U0-G0
			VSQ-W	1234	112	B1-U0-G1	1332	121	B1-U0-G1	1402	127	B1-U0-G1	1472	134	B1-U0-G1		457	51	B1-U0-G0
			II-HS	893	81	B0-U0-G0	964	88	B0-U0-G0	1014	92	B0-U0-G0	1065	97	B0-U0-G0		331	37	B0-U0-G0
			II-FR-HS	884	80	B0-U0-G0	954	87	B0-U0-G0	1004	91	B0-U0-G0	1053	96	B0-U0-G0		328	36	B0-U0-G0
			III-M-HS	911	83	B0-U0-G0	983	89	B0-U0-G0	1034	94	B0-U0-G0	1086	99	B0-U0-G0		338	38	B0-U0-G0
			III-W-HS	890	81	B0-U0-G1	960	87	B0-U0-G1	1011	92	B0-U0-G1	1061	96	B0-U0-G1		330	37	B0-U0-G0
			IV-HS	946	86	B0-U0-G0	1021	93	B0-U0-G0	1075	98	B0-U0-G0	1129	103	B0-U0-G0		351	39	B0-U0-G0
			IV-FT-HS	889	81	B0-U0-G1	959	87	B0-U0-G1	1010	92	B0-U0-G1	1061	96	B0-U0-G1		329	37	B0-U0-G0
			20	350	22.0	II	2162	98	B1-U0-G1	2334	106	B1-U0-G1	2457	112	B1-U0-G1		2579	117	B1-U0-G1
II-FR	2088	95				B1-U0-G0	2253	102	B1-U0-G0	2372	108	B1-U0-G1	2491	113	B1-U0-G1	773	45	B0-U0-G0	
III-M	2211	100				B1-U0-G1	2386	108	B1-U0-G1	2512	114	B1-U0-G1	2637	120	B1-U0-G1	819	48	B0-U0-G0	
III-W	2045	93				B1-U0-G1	2208	100	B1-U0-G1	2324	106	B1-U0-G1	2440	111	B1-U0-G1	758	44	B0-U0-G1	
IV	2225	101				B1-U0-G1	2402	109	B1-U0-G1	2529	115	B1-U0-G1	2655	121	B1-U0-G1	824	48	B0-U0-G0	
IV-FT	1980	90				B0-U0-G1	2137	97	B0-U0-G1	2250	102	B1-U0-G1	2362	107	B1-U0-G1	734	43	B0-U0-G1	
VSQ-N	2292	104				B1-U0-G0	2474	112	B1-U0-G0	2604	118	B1-U0-G0	2734	124	B1-U0-G0	849	50	B1-U0-G0	
VSQ-M	2315	105				B2-U0-G0	2499	114	B2-U0-G1	2631	120	B2-U0-G1	2762	126	B2-U0-G1	858	50	B1-U0-G0	
VSQ-W	2243	102				B2-U0-G1	2422	110	B2-U0-G1	2549	116	B2-U0-G1	2677	122	B2-U0-G1	831	49	B1-U0-G1	
II-HS	1623	74				B0-U0-G0	1751	80	B0-U0-G1	1843	84	B0-U0-G1	1935	88	B0-U0-G1	601	35	B0-U0-G0	
II-FR-HS	1605	73				B0-U0-G0	1733	79	B0-U0-G0	1824	83	B0-U0-G0	1915	87	B0-U0-G0	595	35	B0-U0-G0	
III-M-HS	1655	75				B0-U0-G1	1786	81	B0-U0-G1	1880	85	B0-U0-G1	1973	90	B0-U0-G1	613	36	B0-U0-G0	
III-W-HS	1617	74				B0-U0-G1	1746	79	B0-U0-G1	1838	84	B0-U0-G1	1929	88	B0-U0-G1	599	35	B0-U0-G1	
IV-HS	1720	78				B0-U0-G1	1857	84	B0-U0-G1	1955	89	B0-U0-G1	2052	93	B0-U0-G1	637	37	B0-U0-G0	
IV-FT-HS	1616	73				B0-U0-G1	1745	79	B0-U0-G1	1836	83	B0-U0-G1	1928	88	B0-U0-G1	599	35	B0-U0-G1	
20	525	33.0				II	3069	93	B1-U0-G1	3314	100	B1-U0-G1	3488	106	B1-U0-G1	3662	111	B1-U0-G1	25.8
			II-FR	2964	90	B1-U0-G1	3200	97	B1-U0-G1	3368	102	B1-U0-G1	3537	107	B1-U0-G1	896	35	B0-U0-G0	
			III-M	3139	95	B1-U0-G1	3388	103	B1-U0-G1	3567	108	B1-U0-G1	3745	113	B1-U0-G1	949	37	B0-U0-G0	
			III-W	2904	88	B1-U0-G1	3135	95	B1-U0-G1	3300	100	B1-U0-G1	3465	105	B1-U0-G1	878	34	B0-U0-G1	
			IV	3160	96	B1-U0-G1	3411	103	B1-U0-G1	3590	109	B1-U0-G1	3770	114	B1-U0-G1	955	37	B0-U0-G0	
			IV-FT	2811	85	B1-U0-G1	3035	92	B1-U0-G1	3195	97	B1-U0-G1	3354	102	B1-U0-G1	850	33	B0-U0-G1	
			VSQ-N	3254	99	B2-U0-G0	3513	106	B2-U0-G0	3698	112	B2-U0-G0	3882	118	B2-U0-G0	984	38	B1-U0-G0	
			VSQ-M	3287	100	B2-U0-G1	3548	108	B2-U0-G1	3735	113	B2-U0-G1	3922	119	B2-U0-G1	993	39	B1-U0-G0	
			VSQ-W	3185	97	B2-U0-G1	3439	104	B3-U0-G1	3620	110	B3-U0-G1	3801	115	B3-U0-G1	963	37	B1-U0-G1	
			II-HS	2304	70	B0-U0-G1	2487	75	B0-U0-G1	2618	79	B0-U0-G1	2748	83	B0-U0-G1	696	27	B0-U0-G0	
			II-FR-HS	2280	69	B0-U0-G0	2461	75	B0-U0-G0	2590	78	B0-U0-G0	2719	82	B0-U0-G0	689	27	B0-U0-G0	
			III-M-HS	2349	71	B0-U0-G1	2536	77	B0-U0-G1	2670	81	B0-U0-G1	2803	85	B0-U0-G1	710	28	B0-U0-G0	
			III-W-HS	2296	70	B0-U0-G1	2479	75	B0-U0-G1	2610	79	B0-U0-G1	2740	83	B0-U0-G1	694	27	B0-U0-G1	
			IV-HS	2443	74	B0-U0-G1	2637	80	B0-U0-G1	2775	84	B0-U0-G1	2914	88	B0-U0-G1	738	29	B0-U0-G0	
			IV-FT-HS	2295	70	B0-U0-G1	2477	75	B0-U0-G1	2607	79	B0-U0-G1	2738	83	B0-U0-G1	694	27	B0-U0-G1	
			20	700	44.0	II	3848	87	B1-U0-G1	4154	94	B1-U0-G1	4372	99	B1-U0-G1	4591	104	B1-U0-G1	
II-FR	3715	84				B1-U0-G1	4011	91	B1-U0-G1	4222	96	B1-U0-G1	4433	101	B1-U0-G1				
III-M	3934	89				B1-U0-G1	4247	97	B1-U0-G1	4471	102	B1-U0-G1	4694	107	B1-U0-G1				
III-W	3640	83				B1-U0-G1	3930	89	B1-U0-G1	4137	94	B1-U0-G1	4343	99	B1-U0-G2				
IV	3960	90				B1-U0-G1	4275	97	B1-U0-G1	4501	102	B1-U0-G1	4725	107	B1-U0-G1				
IV-FT	3524	80				B1-U0-G1	3804	86	B1-U0-G2	4005	91	B1-U0-G2	4205	96	B1-U0-G2				
VSQ-N	4079	93				B2-U0-G0	4403	100	B2-U0-G1	4635	105	B2-U0-G1	4867	111	B2-U0-G1				
VSQ-M	4120	94				B2-U0-G1	4448	101	B3-U0-G1	4682	106	B3-U0-G1	4916	112	B3-U0-G1				
VSQ-W	3993	91				B3-U0-G1	4310	98	B3-U0-G1	4537	103	B3-U0-G1	4764	108	B3-U0-G2				
II-HS	2887	66				B0-U0-G1	3117	71	B0-U0-G1	3281	75	B0-U0-G1	3445	78	B0-U0-G1				
II-FR-HS	2857	65				B0-U0-G0	3084	70	B0-U0-G0	3246	74	B0-U0-G0	3408	77	B0-U0-G0				
III-M-HS	2945	67				B0-U0-G1	3179	72	B0-U0-G1	3346	76	B0-U0-G1	3513	80	B0-U0-G1				
III-W-HS	2878	65				B0-U0-G1	3107	71	B0-U0-G1	3271	74	B0-U0-G1	3434	78	B0-U0-G1				
IV-HS	3061	70				B0-U0-G1	3305	75	B0-U0-G1	3479	79	B0-U0-G1	3652	83	B0-U0-G1				
IV-FT-HS	2876	65				B0-U0-G1	3105	71	B0-U0-G1	3268	74	B0-U0-G1	3431	78	B0-U0-G2				
20	875	55.0				II	4626	84	B1-U0-G1	4994	91	B1-U0-G1	5257	96	B1-U0-G1	5519	100	B2-U0-G1	N/A
			II-FR	4467	81	B1-U0-G1	4822	88	B1-U0-G1	5076	92	B1-U0-G1	5330	97	B1-U0-G1				
			III-M	4730	86	B1-U0-G1	5106	93	B1-U0-G1	5375	98	B1-U0-G1	5644	103	B1-U0-G2				
			III-W	4377	80	B1-U0-G2	4724	86	B1-U0-G2	4973	90	B1-U0-G2	5222	95	B1-U0-G2				
			IV	4761	87	B1-U0-G1	5140	93	B1-U0-G1	5411	98	B1-U0-G1	5681	103	B2-U0-G2				
			IV-FT	4237	77	B1-U0-G2	4574	83	B1-U0-G2	4815	88	B1-U0-G2	5055	92	B1-U0-G2				
			VSQ-N	4904	89	B2-U0-G1	5294	96	B2-U0-G1	5573	101	B2-U0-G1	5851	106	B2-U0-G1				
			VSQ-M	4954	90	B3-U0-G1	5348	97	B3-U0-G1	5629	102	B3-U0-G1	5910	107	B3-U0-G1				
			VSQ-W	4800	87	B3-U0-G2	5182	94	B3-U0-G2	5455	99	B3-U0-G2	5727	104	B3-U0-G2				
			II-HS	3471	63	B0-U0-G1	3748	68	B0-U0-G1	3945	72	B0-U0-G1	4141	75	B1-U0-G1				
			II-FR-HS	3435	62	B0-U0-G1	3708	67	B0-U0-G1	3903	71	B0-U0-G1	4098	75	B0-U0-G1				
			III-M-HS	3540	64	B0-U0-G1	3822	69	B0-U0-G1	4023	73	B0-U0-G1	4224	77	B0-U0-G2				
			III-W-HS	3461	63	B0-U0-G1	3736	68	B0-U0-G2	3932	71	B0-U0-G2	4129	75	B0-U0-G2				
			IV-HS	3680	67	B0-U0-G1	3973	72	B0-U0-G1	4182	76	B0-U0-G1	4391	80	B0-U0-G1				
			IV-FT-HS	3458	63	B0-U0-G2	3733	68	B0-U0-G2	3930	71	B0-U0-G2	4126	75	B0-U0-G2				

IES File downloads for this product can be found at www.usaltg.com/downloads/asr.html

SIG SERIES - LED

PHOTOMETRIC DATA GUIDE - LUMEN TABLES (SIG18-PLED)

SIG18-PLED																			
LED Count	Drive Current (mA)	System Watts	Dist'n Type	27K (2700K - 70CRI)			30K (3000K - 70CRI)			40K (4000K - 70CRI)			50K (5000K - 70CRI)			System Watts	TRA (590nm)		
				LUMENS	LPW	BUG RATING	LUMENS	LPW	BUG RATING	LUMENS	LPW	BUG RATING	LUMENS	LPW	BUG RATING		LUMENS	LPW	BUG RATING
36	175	19.8	II	2140	108	B1-U0-G1	2310	117	B1-U0-G1	2432	123	B1-U0-G1	2553	129	B1-U0-G1	16.0	793	50	B0-U0-G0
			II-FR	2067	104	B1-U0-G0	2231	113	B1-U0-G0	2348	119	B1-U0-G0	2466	125	B1-U0-G1		766	48	B0-U0-G0
			III-M	2188	111	B1-U0-G1	2362	119	B1-U0-G1	2487	126	B1-U0-G1	2611	132	B1-U0-G1		811	51	B0-U0-G0
			III-W	2025	102	B1-U0-G1	2186	110	B1-U0-G1	2301	116	B1-U0-G1	2416	122	B1-U0-G1		750	47	B0-U0-G1
			IV	2203	111	B1-U0-G1	2378	120	B1-U0-G1	2503	126	B1-U0-G1	2628	133	B1-U0-G1		816	51	B0-U0-G0
			IV-FT	1960	99	B0-U0-G1	2116	107	B0-U0-G1	2227	112	B1-U0-G1	2339	118	B1-U0-G1		726	45	B0-U0-G1
			VSQ-N	2269	115	B1-U0-G0	2449	124	B1-U0-G0	2578	130	B1-U0-G0	2707	137	B1-U0-G0		841	53	B1-U0-G0
			VSQ-M	2292	116	B2-U0-G0	2474	125	B2-U0-G1	2604	132	B2-U0-G1	2734	138	B2-U0-G1		849	53	B1-U0-G0
			VSQ-W	2221	112	B2-U0-G1	2397	121	B2-U0-G1	2524	127	B2-U0-G1	2649	134	B2-U0-G1		823	51	B1-U0-G1
			II-HS	1606	81	B0-U0-G0	1734	88	B0-U0-G0	1825	92	B0-U0-G1	1916	97	B0-U0-G1		595	37	B0-U0-G0
			II-FR-HS	1589	80	B0-U0-G0	1716	87	B0-U0-G0	1806	91	B0-U0-G0	1896	96	B0-U0-G0		589	37	B0-U0-G0
			III-M-HS	1638	83	B0-U0-G1	1768	89	B0-U0-G1	1861	94	B0-U0-G1	1954	99	B0-U0-G1		607	38	B0-U0-G0
			III-W-HS	1601	81	B0-U0-G1	1728	87	B0-U0-G1	1819	92	B0-U0-G1	1910	96	B0-U0-G1		593	37	B0-U0-G1
			IV-HS	1703	86	B0-U0-G0	1838	93	B0-U0-G1	1935	98	B0-U0-G1	2031	103	B0-U0-G1		631	39	B0-U0-G0
			IV-FT-HS	1600	81	B0-U0-G1	1727	87	B0-U0-G1	1818	92	B0-U0-G1	1908	96	B0-U0-G1		593	37	B0-U0-G1
			36	350	39.6	II	3891	98	B1-U0-G1	4200	106	B1-U0-G1	4421	112	B1-U0-G1		4642	117	B1-U0-G1
II-FR	3757	95				B1-U0-G1	4056	102	B1-U0-G1	4269	108	B1-U0-G1	4483	113	B1-U0-G1	1392	45	B0-U0-G0	
III-M	3979	100				B1-U0-G1	4295	108	B1-U0-G1	4521	114	B1-U0-G1	4747	120	B1-U0-G1	1474	48	B1-U0-G1	
III-W	3681	93				B1-U0-G1	3974	100	B1-U0-G1	4183	106	B1-U0-G1	4392	111	B1-U0-G2	1364	44	B0-U0-G1	
IV	4005	101				B1-U0-G1	4323	109	B1-U0-G1	4551	115	B1-U0-G1	4778	121	B1-U0-G1	1484	48	B1-U0-G1	
IV-FT	3564	90				B1-U0-G1	3847	97	B1-U0-G2	4050	102	B1-U0-G2	4252	107	B1-U0-G2	1320	43	B0-U0-G1	
VSQ-N	4125	104				B2-U0-G1	4453	112	B2-U0-G1	4687	118	B2-U0-G1	4921	124	B2-U0-G1	1528	50	B1-U0-G0	
VSQ-M	4167	105				B3-U0-G1	4498	114	B3-U0-G1	4735	120	B3-U0-G1	4971	126	B3-U0-G1	1544	50	B1-U0-G0	
VSQ-W	4037	102				B3-U0-G1	4358	110	B3-U0-G1	4588	116	B3-U0-G1	4817	122	B3-U0-G2	1496	49	B1-U0-G1	
II-HS	2920	74				B0-U0-G1	3152	80	B0-U0-G1	3318	84	B0-U0-G1	3483	88	B0-U0-G1	1082	35	B0-U0-G0	
II-FR-HS	2889	73				B0-U0-G0	3119	79	B0-U0-G0	3283	83	B0-U0-G0	3446	87	B0-U0-G1	1070	35	B0-U0-G0	
III-M-HS	2978	75				B0-U0-G1	3214	81	B0-U0-G1	3383	85	B0-U0-G1	3552	90	B0-U0-G1	1103	36	B0-U0-G0	
III-W-HS	2910	73				B0-U0-G1	3142	79	B0-U0-G1	3307	84	B0-U0-G1	3472	88	B0-U0-G1	1078	35	B0-U0-G1	
IV-HS	3096	78				B0-U0-G1	3342	84	B0-U0-G1	3518	89	B0-U0-G1	3693	93	B0-U0-G1	1147	37	B0-U0-G0	
IV-FT-HS	2908	73				B0-U0-G1	3139	79	B0-U0-G1	3305	83	B0-U0-G1	3470	88	B0-U0-G2	1077	35	B0-U0-G1	
36	525	59.4				II	5525	93	B2-U0-G1	5964	100	B2-U0-G1	6278	106	B2-U0-G2	6592	111	B2-U0-G2	46.5
			II-FR	5335	90	B1-U0-G1	5759	97	B1-U0-G1	6063	102	B1-U0-G1	6366	107	B1-U0-G1	1613	35	B0-U0-G0	
			III-M	5649	95	B1-U0-G2	6098	103	B2-U0-G2	6419	108	B2-U0-G2	6740	113	B2-U0-G2	1708	37	B1-U0-G1	
			III-W	5227	88	B1-U0-G2	5642	95	B1-U0-G2	5940	100	B1-U0-G2	6236	105	B1-U0-G2	1580	34	B0-U0-G1	
			IV	5687	96	B2-U0-G2	6139	103	B2-U0-G2	6462	109	B2-U0-G2	6785	114	B2-U0-G2	1719	37	B1-U0-G1	
			IV-FT	5060	85	B1-U0-G2	5462	92	B1-U0-G2	5750	97	B1-U0-G2	6038	102	B1-U0-G2	1530	33	B0-U0-G1	
			VSQ-N	5857	99	B2-U0-G1	6323	106	B2-U0-G1	6655	112	B2-U0-G1	6988	118	B2-U0-G1	1770	38	B1-U0-G0	
			VSQ-M	5916	100	B3-U0-G1	6387	108	B3-U0-G1	6723	113	B3-U0-G1	7059	119	B3-U0-G1	1788	38	B1-U0-G0	
			VSQ-W	5733	97	B3-U0-G2	6189	104	B3-U0-G2	6515	110	B3-U0-G2	6841	115	B3-U0-G2	1733	37	B2-U0-G1	
			II-HS	4146	70	B1-U0-G1	4476	75	B1-U0-G1	4711	79	B1-U0-G1	4946	83	B1-U0-G2	1253	27	B0-U0-G0	
			II-FR-HS	4102	69	B0-U0-G1	4428	75	B0-U0-G1	4661	78	B1-U0-G1	4894	82	B1-U0-G1	1240	27	B0-U0-G0	
			III-M-HS	4228	71	B0-U0-G2	4564	77	B0-U0-G2	4804	81	B0-U0-G2	5044	85	B0-U0-G2	1278	27	B0-U0-G0	
			III-W-HS	4133	70	B0-U0-G2	4462	75	B0-U0-G2	4696	79	B0-U0-G2	4931	83	B0-U0-G2	1249	27	B0-U0-G1	
			IV-HS	4396	74	B0-U0-G1	4745	80	B0-U0-G2	4995	84	B0-U0-G2	5244	88	B0-U0-G2	1329	29	B0-U0-G0	
			IV-FT-HS	4130	70	B0-U0-G2	4458	75	B0-U0-G2	4693	79	B0-U0-G2	4927	83	B0-U0-G2	1248	27	B0-U0-G1	
			36	700	79.2	II	6925	87	B2-U0-G2	7476	94	B2-U0-G2	7870	99	B2-U0-G2	8263	104	B2-U0-G2	
II-FR	6687	84				B1-U0-G1	7219	91	B1-U0-G1	7599	96	B1-U0-G1	7979	101	B2-U0-G1				
III-M	7082	89				B2-U0-G2	7645	97	B2-U0-G2	8047	102	B2-U0-G2	8449	107	B2-U0-G2				
III-W	6552	83				B1-U0-G2	7073	89	B1-U0-G2	7445	94	B1-U0-G2	7818	99	B1-U0-G2				
IV	7128	90				B2-U0-G2	7695	97	B2-U0-G2	8100	102	B2-U0-G2	8505	107	B2-U0-G2				
IV-FT	6343	80				B1-U0-G2	6847	86	B1-U0-G2	7208	91	B1-U0-G2	7568	96	B1-U0-G2				
VSQ-N	7342	93				B2-U0-G1	7925	100	B3-U0-G1	8343	105	B3-U0-G1	8760	111	B3-U0-G1				
VSQ-M	7416	94				B3-U0-G1	8006	101	B3-U0-G2	8427	106	B3-U0-G2	8849	112	B3-U0-G2				
VSQ-W	7187	91				B3-U0-G2	7758	98	B3-U0-G2	8167	103	B3-U0-G2	8575	108	B4-U0-G2				
II-HS	5197	66				B1-U0-G2	5610	71	B1-U0-G2	5905	75	B1-U0-G2	6200	78	B1-U0-G2				
II-FR-HS	5142	65				B1-U0-G1	5551	70	B1-U0-G1	5843	74	B1-U0-G1	6135	77	B1-U0-G1				
III-M-HS	5300	67				B0-U0-G2	5721	72	B0-U0-G2	6022	76	B0-U0-G2	6323	80	B0-U0-G2				
III-W-HS	5181	65				B0-U0-G2	5593	71	B0-U0-G2	5887	74	B0-U0-G2	6181	78	B0-U0-G2				
IV-HS	5510	70				B0-U0-G2	5948	75	B0-U0-G2	6261	79	B1-U0-G2	6574	83	B1-U0-G2				
IV-FT-HS	5177	65				B0-U0-G2	5588	71	B1-U0-G2	5883	74	B1-U0-G2	6177	78	B1-U0-G2				
36	875	99.0				II	8326	84	B2-U0-G2	8988	91	B2-U0-G2	9462	96	B2-U0-G2	9934	100	B2-U0-G2	N/A
			II-FR	8040	81	B2-U0-G1	8680	88	B2-U0-G1	9137	92	B2-U0-G1	9593	97	B2-U0-G1				
			III-M	8514	86	B2-U0-G2	9191	93	B2-U0-G2	9675	98	B2-U0-G2	10158	103	B2-U0-G2				
			III-W	7877	80	B2-U0-G2	8504	86	B2-U0-G2	8951	90	B2-U0-G2	9399	95	B2-U0-G2				
			IV	8570	87	B2-U0-G2	9251	93	B2-U0-G2	9739	98	B2-U0-G2	10225	103	B2-U0-G2				
			IV-FT	7626	77	B1-U0-G2	8232	83	B1-U0-G3	8666	88	B1-U0-G3	9099	92	B1-U0-G3				
			VSQ-N	8826	89	B3-U0-G1	9528	96	B3-U0-G1	10030	101	B3-U0-G1	10532	106	B3-U0-G1				
			VSQ-M	8916	90	B3-U0-G2	9625	97	B3-U0-G2	10132	102	B3-U0-G2	10638	107	B4-U0-G2				
			VSQ-W	8640	87	B4-U0-G2	9327	94	B4-U0-G2	9818	99	B4-U0-G2	10309	104	B4-U0-G2				
			II-HS	6248	63	B1-U0-G2	6745	68	B1-U0-G2	7100	72	B1-U0-G2	7455	75	B1-U0-G2				
			II-FR-HS	6182	62	B1-U0-G1	6673	67	B1-U0-G1	7025	71	B1-U0-G1	7376	75	B1-U0-G1				
			III-M-HS	6372	64	B1-U0-G2	6878	69	B1-U0-G2	7240	73	B1-U0-G2	7602	77	B1-U0-G2				
			III-W-HS	6229	63	B0-U0-G2	6724	68	B1-U0-G2	7078	71	B1-U0-G2	7432	75	B1-U0-G2				
			IV-HS	6625	67	B1-U0-G2	7151	72	B1-U0-G2	7528	76	B1-U0-G2	7904	80	B1-U0-G2				
			IV-FT-HS	6224	63	B1-U0-G2	6719	68	B1-U0-G2	7073	71	B1-U0-G2	7426	75	B1-U0-G2				

IES File downloads for this product can be found at www.usaltg.com/downloads/asr.html

SIG SERIES - LED

PHOTOMETRIC DATA GUIDE - LUMEN TABLES (SIG23-PLED)

SIG23-PLED																			
LED Count	Drive Current (mA)	System Watts	Dist'n Type	27K (2700K - 70CRI)			30K (3000K - 70CRI)			40K (4000K - 70CRI)			50K (5000K - 70CRI)			System Watts	TRA (590nm)		
				LUMENS	LPW	BUG RATING	LUMENS	LPW	BUG RATING	LUMENS	LPW	BUG RATING	LUMENS	LPW	BUG RATING		LUMENS	LPW	BUG RATING
20	175	11.0	II	1189	108	B1-U0-G0	1284	117	B1-U0-G0	1351	123	B1-U0-G0	1419	129	B1-U0-G1	9.0	441	49	B0-U0-G0
			II-FR	1148	104	B0-U0-G0	1239	113	B0-U0-G0	1305	119	B0-U0-G0	1370	125	B0-U0-G0		425	47	B0-U0-G0
			III-M	1216	111	B0-U0-G0	1313	119	B1-U0-G0	1382	126	B1-U0-G0	1451	132	B1-U0-G1		451	50	B0-U0-G0
			III-W	1125	102	B0-U0-G1	1214	110	B0-U0-G1	1278	116	B0-U0-G1	1342	122	B0-U0-G1		417	46	B0-U0-G0
			IV	1224	111	B0-U0-G0	1321	120	B1-U0-G0	1391	126	B1-U0-G1	1460	133	B1-U0-G1		453	50	B0-U0-G0
			IV-FT	1089	99	B0-U0-G1	1176	107	B0-U0-G1	1238	113	B0-U0-G1	1299	118	B0-U0-G1		404	45	B0-U0-G1
			VSQ-N	1261	115	B1-U0-G0	1361	124	B1-U0-G0	1433	130	B1-U0-G0	1504	137	B1-U0-G0		467	52	B0-U0-G0
			VSQ-M	1273	116	B1-U0-G0	1374	125	B1-U0-G0	1447	132	B1-U0-G0	1519	138	B1-U0-G0		472	52	B1-U0-G0
			VSQ-W	1234	112	B1-U0-G1	1332	121	B1-U0-G1	1402	127	B1-U0-G1	1472	134	B1-U0-G1		457	51	B1-U0-G0
			II-HS	893	81	B0-U0-G0	964	88	B0-U0-G0	1014	92	B0-U0-G0	1065	97	B0-U0-G0		331	37	B0-U0-G0
			II-FR-HS	884	80	B0-U0-G0	954	87	B0-U0-G0	1004	91	B0-U0-G0	1053	96	B0-U0-G0		328	36	B0-U0-G0
			III-M-HS	911	83	B0-U0-G0	983	89	B0-U0-G0	1034	94	B0-U0-G0	1086	99	B0-U0-G0		338	38	B0-U0-G0
			III-W-HS	890	81	B0-U0-G1	960	87	B0-U0-G1	1011	92	B0-U0-G1	1061	96	B0-U0-G1		330	37	B0-U0-G0
			IV-HS	946	86	B0-U0-G0	1021	93	B0-U0-G0	1075	98	B0-U0-G0	1129	103	B0-U0-G0		351	39	B0-U0-G0
			IV-FT-HS	889	81	B0-U0-G1	959	87	B0-U0-G1	1010	92	B0-U0-G1	1061	96	B0-U0-G1		329	37	B0-U0-G0
			20	350	22.0	II	2162	98	B1-U0-G1	2334	106	B1-U0-G1	2457	112	B1-U0-G1		2579	117	B1-U0-G1
II-FR	2088	95				B1-U0-G0	2253	102	B1-U0-G0	2372	108	B1-U0-G1	2491	113	B1-U0-G1	773	45	B0-U0-G0	
III-M	2211	100				B1-U0-G1	2386	108	B1-U0-G1	2512	114	B1-U0-G1	2637	120	B1-U0-G1	819	48	B0-U0-G0	
III-W	2045	93				B1-U0-G1	2208	100	B1-U0-G1	2324	106	B1-U0-G1	2440	111	B1-U0-G1	758	44	B0-U0-G1	
IV	2225	101				B1-U0-G1	2402	109	B1-U0-G1	2529	115	B1-U0-G1	2655	121	B1-U0-G1	824	48	B0-U0-G0	
IV-FT	1980	90				B0-U0-G1	2137	97	B0-U0-G1	2250	102	B1-U0-G1	2362	107	B1-U0-G1	734	43	B0-U0-G1	
VSQ-N	2292	104				B1-U0-G0	2474	112	B1-U0-G0	2604	118	B1-U0-G0	2734	124	B1-U0-G0	849	50	B1-U0-G0	
VSQ-M	2315	105				B2-U0-G0	2499	114	B2-U0-G1	2631	120	B2-U0-G1	2762	126	B2-U0-G1	858	50	B1-U0-G0	
VSQ-W	2243	102				B2-U0-G1	2422	110	B2-U0-G1	2549	116	B2-U0-G1	2677	122	B2-U0-G1	831	49	B1-U0-G1	
II-HS	1623	74				B0-U0-G0	1751	80	B0-U0-G1	1843	84	B0-U0-G1	1935	88	B0-U0-G1	601	35	B0-U0-G0	
II-FR-HS	1605	73				B0-U0-G0	1733	79	B0-U0-G0	1824	83	B0-U0-G0	1915	87	B0-U0-G0	595	35	B0-U0-G0	
III-M-HS	1655	75				B0-U0-G1	1786	81	B0-U0-G1	1880	85	B0-U0-G1	1973	90	B0-U0-G1	613	36	B0-U0-G0	
III-W-HS	1617	74				B0-U0-G1	1746	79	B0-U0-G1	1838	84	B0-U0-G1	1929	88	B0-U0-G1	599	35	B0-U0-G1	
IV-HS	1720	78				B0-U0-G1	1857	84	B0-U0-G1	1955	89	B0-U0-G1	2052	93	B0-U0-G1	637	37	B0-U0-G0	
IV-FT-HS	1616	73				B0-U0-G1	1745	79	B0-U0-G1	1836	83	B0-U0-G1	1928	88	B0-U0-G1	599	35	B0-U0-G1	
20	525	33.0				II	3069	93	B1-U0-G1	3314	100	B1-U0-G1	3488	106	B1-U0-G1	3662	111	B1-U0-G1	25.8
			II-FR	2964	90	B1-U0-G1	3200	97	B1-U0-G1	3368	102	B1-U0-G1	3537	107	B1-U0-G1	896	35	B0-U0-G0	
			III-M	3139	95	B1-U0-G1	3388	103	B1-U0-G1	3567	108	B1-U0-G1	3745	113	B1-U0-G1	949	37	B0-U0-G0	
			III-W	2904	88	B1-U0-G1	3135	95	B1-U0-G1	3300	100	B1-U0-G1	3465	105	B1-U0-G1	878	34	B0-U0-G1	
			IV	3160	96	B1-U0-G1	3411	103	B1-U0-G1	3590	109	B1-U0-G1	3770	114	B1-U0-G1	955	37	B0-U0-G0	
			IV-FT	2811	85	B1-U0-G1	3035	92	B1-U0-G1	3195	97	B1-U0-G1	3354	102	B1-U0-G1	850	33	B0-U0-G1	
			VSQ-N	3254	99	B2-U0-G0	3513	106	B2-U0-G0	3698	112	B2-U0-G0	3882	118	B2-U0-G0	984	38	B1-U0-G0	
			VSQ-M	3287	100	B2-U0-G1	3548	108	B2-U0-G1	3735	113	B2-U0-G1	3922	119	B2-U0-G1	993	39	B1-U0-G0	
			VSQ-W	3185	97	B2-U0-G1	3439	104	B3-U0-G1	3620	110	B3-U0-G1	3801	115	B3-U0-G1	963	37	B1-U0-G1	
			II-HS	2304	70	B0-U0-G1	2487	75	B0-U0-G1	2618	79	B0-U0-G1	2748	83	B0-U0-G1	696	27	B0-U0-G0	
			II-FR-HS	2280	69	B0-U0-G0	2461	75	B0-U0-G0	2590	78	B0-U0-G0	2719	82	B0-U0-G0	689	27	B0-U0-G0	
			III-M-HS	2349	71	B0-U0-G1	2536	77	B0-U0-G1	2670	81	B0-U0-G1	2803	85	B0-U0-G1	710	28	B0-U0-G0	
			III-W-HS	2296	70	B0-U0-G1	2479	75	B0-U0-G1	2610	79	B0-U0-G1	2740	83	B0-U0-G1	694	27	B0-U0-G1	
			IV-HS	2443	74	B0-U0-G1	2637	80	B0-U0-G1	2775	84	B0-U0-G1	2914	88	B0-U0-G1	738	29	B0-U0-G0	
			IV-FT-HS	2295	70	B0-U0-G1	2477	75	B0-U0-G1	2607	79	B0-U0-G1	2738	83	B0-U0-G1	694	27	B0-U0-G1	
			20	700	44.0	II	3848	87	B1-U0-G1	4154	94	B1-U0-G1	4372	99	B1-U0-G1	4591	104	B1-U0-G1	
II-FR	3715	84				B1-U0-G1	4011	91	B1-U0-G1	4222	96	B1-U0-G1	4433	101	B1-U0-G1				
III-M	3934	89				B1-U0-G1	4247	97	B1-U0-G1	4471	102	B1-U0-G1	4694	107	B1-U0-G1				
III-W	3640	83				B1-U0-G1	3930	89	B1-U0-G1	4137	94	B1-U0-G1	4343	99	B1-U0-G2				
IV	3960	90				B1-U0-G1	4275	97	B1-U0-G1	4501	102	B1-U0-G1	4725	107	B1-U0-G1				
IV-FT	3524	80				B1-U0-G1	3804	86	B1-U0-G2	4005	91	B1-U0-G2	4205	96	B1-U0-G2				
VSQ-N	4079	93				B2-U0-G0	4403	100	B2-U0-G1	4635	105	B2-U0-G1	4867	111	B2-U0-G1				
VSQ-M	4120	94				B2-U0-G1	4448	101	B3-U0-G1	4682	106	B3-U0-G1	4916	112	B3-U0-G1				
VSQ-W	3993	91				B3-U0-G1	4310	98	B3-U0-G1	4537	103	B3-U0-G1	4764	108	B3-U0-G2				
II-HS	2887	66				B0-U0-G1	3117	71	B0-U0-G1	3281	75	B0-U0-G1	3445	78	B0-U0-G1				
II-FR-HS	2857	65				B0-U0-G0	3084	70	B0-U0-G0	3246	74	B0-U0-G0	3408	77	B0-U0-G0				
III-M-HS	2945	67				B0-U0-G1	3179	72	B0-U0-G1	3346	76	B0-U0-G1	3513	80	B0-U0-G1				
III-W-HS	2878	65				B0-U0-G1	3107	71	B0-U0-G1	3271	74	B0-U0-G1	3434	78	B0-U0-G1				
IV-HS	3061	70				B0-U0-G1	3305	75	B0-U0-G1	3479	79	B0-U0-G1	3652	83	B0-U0-G1				
IV-FT-HS	2876	65				B0-U0-G1	3105	71	B0-U0-G1	3268	74	B0-U0-G1	3431	78	B0-U0-G2				
20	875	55.0				II	4626	84	B1-U0-G1	4994	91	B1-U0-G1	5257	96	B1-U0-G1	5519	100	B2-U0-G1	N/A
			II-FR	4467	81	B1-U0-G1	4822	88	B1-U0-G1	5076	92	B1-U0-G1	5330	97	B1-U0-G1				
			III-M	4730	86	B1-U0-G1	5106	93	B1-U0-G1	5375	98	B1-U0-G1	5644	103	B1-U0-G2				
			III-W	4377	80	B1-U0-G2	4724	86	B1-U0-G2	4973	90	B1-U0-G2	5222	95	B1-U0-G2				
			IV	4761	87	B1-U0-G1	5140	93	B1-U0-G1	5411	98	B1-U0-G1	5681	103	B2-U0-G2				
			IV-FT	4237	77	B1-U0-G2	4574	83	B1-U0-G2	4815	88	B1-U0-G2	5055	92	B1-U0-G2				
			VSQ-N	4904	89	B2-U0-G1	5294	96	B2-U0-G1	5573	101	B2-U0-G1	5851	106	B2-U0-G1				
			VSQ-M	4954	90	B3-U0-G1	5348	97	B3-U0-G1	5629	102	B3-U0-G1	5910	107	B3-U0-G1				
			VSQ-W	4800	87	B3-U0-G2	5182	94	B3-U0-G2	5455	99	B3-U0-G2	5727	104	B3-U0-G2				
			II-HS	3471	63	B0-U0-G1	3748	68	B0-U0-G1	3945	72	B0-U0-G1	4141	75	B1-U0-G1				
			II-FR-HS	3435	62	B0-U0-G1	3708	67	B0-U0-G1	3903	71	B0-U0-G1	4098	75	B0-U0-G1				
			III-M-HS	3540	64	B0-U0-G1	3822	69	B0-U0-G1	4023	73	B0-U0-G1	4224	77	B0-U0-G2				
			III-W-HS	3461	63	B0-U0-G1	3736	68	B0-U0-G2	3932	71	B0-U0-G2	4129	75	B0-U0-G2				
			IV-HS	3680	67	B0-U0-G1	3973	72	B0-U0-G1	4182	76	B0-U0-G1	4391	80	B0-U0-G1				
			IV-FT-HS	3458	63	B0-U0-G2	3733	68	B0-U0-G2	3930	71	B0-U0-G2	4126	75	B0-U0-G2				

IES File downloads for this product can be found at www.usaltg.com/downloads/asr.html

SIG SERIES - LED

PHOTOMETRIC DATA GUIDE - LUMEN TABLES (SIG23-PLED)

SIG23-PLED																			
LED Count	Drive Current (mA)	System Watts	Dist'n Type	27K (2700K - 70CRI)			30K (3000K - 70CRI)			40K (4000K - 70CRI)			50K (5000K - 70CRI)			System Watts	TRA (590nm)		
				LUMENS	LPW	BUG RATING	LUMENS	LPW	BUG RATING	LUMENS	LPW	BUG RATING	LUMENS	LPW	BUG RATING		LUMENS	LPW	BUG RATING
36	175	19.8	II	2140	108	B1-U0-G1	2310	117	B1-U0-G1	2432	123	B1-U0-G1	2553	129	B1-U0-G1	16.0	793	50	B0-U0-G0
			II-FR	2067	104	B1-U0-G0	2231	113	B1-U0-G0	2348	119	B1-U0-G0	2466	125	B1-U0-G1		766	48	B0-U0-G0
			III-M	2188	111	B1-U0-G1	2362	119	B1-U0-G1	2487	126	B1-U0-G1	2611	132	B1-U0-G1		811	51	B0-U0-G0
			III-W	2025	102	B1-U0-G1	2186	110	B1-U0-G1	2301	116	B1-U0-G1	2416	122	B1-U0-G1		750	47	B0-U0-G1
			IV	2203	111	B1-U0-G1	2378	120	B1-U0-G1	2503	126	B1-U0-G1	2628	133	B1-U0-G1		816	51	B0-U0-G0
			IV-FT	1960	99	B0-U0-G1	2116	107	B0-U0-G1	2227	112	B1-U0-G1	2339	118	B1-U0-G1		726	45	B0-U0-G1
			VSQ-N	2269	115	B1-U0-G0	2449	124	B1-U0-G0	2578	130	B1-U0-G0	2707	137	B1-U0-G0		841	53	B1-U0-G0
			VSQ-M	2292	116	B2-U0-G0	2474	125	B2-U0-G1	2604	132	B2-U0-G1	2734	138	B2-U0-G1		849	53	B1-U0-G0
			VSQ-W	2221	112	B2-U0-G1	2397	121	B2-U0-G1	2524	127	B2-U0-G1	2649	134	B2-U0-G1		823	51	B1-U0-G1
			II-HS	1606	81	B0-U0-G0	1734	88	B0-U0-G0	1825	92	B0-U0-G1	1916	97	B0-U0-G1		595	37	B0-U0-G0
			II-FR-HS	1589	80	B0-U0-G0	1716	87	B0-U0-G0	1806	91	B0-U0-G0	1896	96	B0-U0-G0		589	37	B0-U0-G0
			III-M-HS	1638	83	B0-U0-G1	1768	89	B0-U0-G1	1861	94	B0-U0-G1	1954	99	B0-U0-G1		607	38	B0-U0-G0
			III-W-HS	1601	81	B0-U0-G1	1728	87	B0-U0-G1	1819	92	B0-U0-G1	1910	96	B0-U0-G1		593	37	B0-U0-G1
			IV-HS	1703	86	B0-U0-G0	1838	93	B0-U0-G1	1935	98	B0-U0-G1	2031	103	B0-U0-G1		631	39	B0-U0-G0
			IV-FT-HS	1600	81	B0-U0-G1	1727	87	B0-U0-G1	1818	92	B0-U0-G1	1908	96	B0-U0-G1		593	37	B0-U0-G1
			36	350	39.6	II	3891	98	B1-U0-G1	4200	106	B1-U0-G1	4421	112	B1-U0-G1		4642	117	B1-U0-G1
II-FR	3757	95				B1-U0-G1	4056	102	B1-U0-G1	4269	108	B1-U0-G1	4483	113	B1-U0-G1	1392	45	B0-U0-G0	
III-M	3979	100				B1-U0-G1	4295	108	B1-U0-G1	4521	114	B1-U0-G1	4747	120	B1-U0-G1	1474	48	B1-U0-G1	
III-W	3681	93				B1-U0-G1	3974	100	B1-U0-G1	4183	106	B1-U0-G1	4392	111	B1-U0-G2	1364	44	B0-U0-G1	
IV	4005	101				B1-U0-G1	4323	109	B1-U0-G1	4551	115	B1-U0-G1	4778	121	B1-U0-G1	1484	48	B1-U0-G1	
IV-FT	3564	90				B1-U0-G1	3847	97	B1-U0-G2	4050	102	B1-U0-G2	4252	107	B1-U0-G2	1320	43	B0-U0-G1	
VSQ-N	4125	104				B2-U0-G1	4453	112	B2-U0-G1	4687	118	B2-U0-G1	4921	124	B2-U0-G1	1528	50	B1-U0-G0	
VSQ-M	4167	105				B3-U0-G1	4498	114	B3-U0-G1	4735	120	B3-U0-G1	4971	126	B3-U0-G1	1544	50	B1-U0-G0	
VSQ-W	4037	102				B3-U0-G1	4358	110	B3-U0-G1	4588	116	B3-U0-G1	4817	122	B3-U0-G2	1496	49	B1-U0-G1	
II-HS	2920	74				B0-U0-G1	3152	80	B0-U0-G1	3318	84	B0-U0-G1	3483	88	B0-U0-G1	1082	35	B0-U0-G0	
II-FR-HS	2889	73				B0-U0-G0	3119	79	B0-U0-G0	3283	83	B0-U0-G0	3446	87	B0-U0-G1	1070	35	B0-U0-G0	
III-M-HS	2978	75				B0-U0-G1	3214	81	B0-U0-G1	3383	85	B0-U0-G1	3552	90	B0-U0-G1	1103	36	B0-U0-G0	
III-W-HS	2910	73				B0-U0-G1	3142	79	B0-U0-G1	3307	84	B0-U0-G1	3472	88	B0-U0-G1	1078	35	B0-U0-G1	
IV-HS	3096	78				B0-U0-G1	3342	84	B0-U0-G1	3518	89	B0-U0-G1	3693	93	B0-U0-G1	1147	37	B0-U0-G0	
IV-FT-HS	2908	73				B0-U0-G1	3139	79	B0-U0-G1	3305	83	B0-U0-G1	3470	88	B0-U0-G2	1077	35	B0-U0-G1	
36	525	59.4				II	5525	93	B2-U0-G1	5964	100	B2-U0-G1	6278	106	B2-U0-G2	6592	111	B2-U0-G2	46.5
			II-FR	5335	90	B1-U0-G1	5759	97	B1-U0-G1	6063	102	B1-U0-G1	6366	107	B1-U0-G1	1613	35	B0-U0-G0	
			III-M	5649	95	B1-U0-G2	6098	103	B2-U0-G2	6419	108	B2-U0-G2	6740	113	B2-U0-G2	1708	37	B1-U0-G1	
			III-W	5227	88	B1-U0-G2	5642	95	B1-U0-G2	5940	100	B1-U0-G2	6236	105	B1-U0-G2	1580	34	B0-U0-G1	
			IV	5687	96	B2-U0-G2	6139	103	B2-U0-G2	6462	109	B2-U0-G2	6785	114	B2-U0-G2	1719	37	B1-U0-G1	
			IV-FT	5060	85	B1-U0-G2	5462	92	B1-U0-G2	5750	97	B1-U0-G2	6038	102	B1-U0-G2	1530	33	B0-U0-G1	
			VSQ-N	5857	99	B2-U0-G1	6323	106	B2-U0-G1	6655	112	B2-U0-G1	6988	118	B2-U0-G1	1770	38	B1-U0-G0	
			VSQ-M	5916	100	B3-U0-G1	6387	108	B3-U0-G1	6723	113	B3-U0-G1	7059	119	B3-U0-G1	1788	38	B1-U0-G0	
			VSQ-W	5733	97	B3-U0-G2	6189	104	B3-U0-G2	6515	110	B3-U0-G2	6841	115	B3-U0-G2	1733	37	B2-U0-G1	
			II-HS	4146	70	B1-U0-G1	4476	75	B1-U0-G1	4711	79	B1-U0-G1	4946	83	B1-U0-G2	1253	27	B0-U0-G0	
			II-FR-HS	4102	69	B0-U0-G1	4428	75	B0-U0-G1	4661	78	B1-U0-G1	4894	82	B1-U0-G1	1240	27	B0-U0-G0	
			III-M-HS	4228	71	B0-U0-G2	4564	77	B0-U0-G2	4804	81	B0-U0-G2	5044	85	B0-U0-G2	1278	27	B0-U0-G0	
			III-W-HS	4133	70	B0-U0-G2	4462	75	B0-U0-G2	4696	79	B0-U0-G2	4931	83	B0-U0-G2	1249	27	B0-U0-G1	
			IV-HS	4396	74	B0-U0-G1	4745	80	B0-U0-G2	4995	84	B0-U0-G2	5244	88	B0-U0-G2	1329	29	B0-U0-G0	
			IV-FT-HS	4130	70	B0-U0-G2	4458	75	B0-U0-G2	4693	79	B0-U0-G2	4927	83	B0-U0-G2	1248	27	B0-U0-G1	
			36	700	79.2	II	6925	87	B2-U0-G2	7476	94	B2-U0-G2	7870	99	B2-U0-G2	8263	104	B2-U0-G2	
II-FR	6687	84				B1-U0-G1	7219	91	B1-U0-G1	7599	96	B1-U0-G1	7979	101	B2-U0-G1				
III-M	7082	89				B2-U0-G2	7645	97	B2-U0-G2	8047	102	B2-U0-G2	8449	107	B2-U0-G2				
III-W	6552	83				B1-U0-G2	7073	89	B1-U0-G2	7445	94	B1-U0-G2	7818	99	B1-U0-G2				
IV	7128	90				B2-U0-G2	7695	97	B2-U0-G2	8100	102	B2-U0-G2	8505	107	B2-U0-G2				
IV-FT	6343	80				B1-U0-G2	6847	86	B1-U0-G2	7208	91	B1-U0-G2	7568	96	B1-U0-G2				
VSQ-N	7342	93				B2-U0-G1	7925	100	B3-U0-G1	8343	105	B3-U0-G1	8760	111	B3-U0-G1				
VSQ-M	7416	94				B3-U0-G1	8006	101	B3-U0-G2	8427	106	B3-U0-G2	8849	112	B3-U0-G2				
VSQ-W	7187	91				B3-U0-G2	7758	98	B3-U0-G2	8167	103	B3-U0-G2	8575	108	B4-U0-G2				
II-HS	5197	66				B1-U0-G2	5610	71	B1-U0-G2	5905	75	B1-U0-G2	6200	78	B1-U0-G2				
II-FR-HS	5142	65				B1-U0-G1	5551	70	B1-U0-G1	5843	74	B1-U0-G1	6135	77	B1-U0-G1				
III-M-HS	5300	67				B0-U0-G2	5721	72	B0-U0-G2	6022	76	B0-U0-G2	6323	80	B0-U0-G2				
III-W-HS	5181	65				B0-U0-G2	5593	71	B0-U0-G2	5887	74	B0-U0-G2	6181	78	B0-U0-G2				
IV-HS	5510	70				B0-U0-G2	5948	75	B0-U0-G2	6261	79	B1-U0-G2	6574	83	B1-U0-G2				
IV-FT-HS	5177	65				B0-U0-G2	5588	71	B1-U0-G2	5883	74	B1-U0-G2	6177	78	B1-U0-G2				
36	875	99.0				II	8326	84	B2-U0-G2	8988	91	B2-U0-G2	9462	96	B2-U0-G2	9934	100	B2-U0-G2	N/A
			II-FR	8040	81	B2-U0-G1	8680	88	B2-U0-G1	9137	92	B2-U0-G1	9593	97	B2-U0-G1				
			III-M	8514	86	B2-U0-G2	9191	93	B2-U0-G2	9675	98	B2-U0-G2	10158	103	B2-U0-G2				
			III-W	7877	80	B2-U0-G2	8504	86	B2-U0-G2	8951	90	B2-U0-G2	9399	95	B2-U0-G2				
			IV	8570	87	B2-U0-G2	9251	93	B2-U0-G2	9739	98	B2-U0-G2	10225	103	B2-U0-G2				
			IV-FT	7626	77	B1-U0-G2	8232	83	B1-U0-G3	8666	88	B1-U0-G3	9099	92	B1-U0-G3				
			VSQ-N	8826	89	B3-U0-G1	9528	96	B3-U0-G1	10030	101	B3-U0-G1	10532	106	B3-U0-G1				
			VSQ-M	8916	90	B3-U0-G2	9625	97	B3-U0-G2	10132	102	B3-U0-G2	10638	107	B4-U0-G2				
			VSQ-W	8640	87	B4-U0-G2	9327	94	B4-U0-G2	9818	99	B4-U0-G2	10309	104	B4-U0-G2				
			II-HS	6248	63	B1-U0-G2	6745	68	B1-U0-G2	7100	72	B1-U0-G2	7455	75	B1-U0-G2				
			II-FR-HS	6182	62	B1-U0-G1	6673	67	B1-U0-G1	7025	71	B1-U0-G1	7376	75	B1-U0-G1				
			III-M-HS	6372	64	B1-U0-G2	6878	69	B1-U0-G2	7240	73	B1-U0-G2	7602	77	B1-U0-G2				
			III-W-HS	6229	63	B0-U0-G2	6724	68	B1-U0-G2	7078	71	B1-U0-G2	7432	75	B1-U0-G2				
			IV-HS	6625	67	B1-U0-G2	7151	72	B1-U0-G2	7528	76	B1-U0-G2	7904	80	B1-U0-G2				
			IV-FT-HS	6224	63	B1-U0-G2	6719	68	B1-U0-G2	7073	71	B1-U0-G2	7426	75	B1-U0-G2				

IES File downloads for this product can be found at www.usaltg.com/downloads/asr.html

SIG SERIES - LED

PHOTOMETRIC DATA GUIDE - LUMEN TABLES (SIG23-PLED)

SIG23-PLED																			
LED Count	Drive Current (mA)	System Watts	Dist'n Type	27K (2700K - 70CRI)			30K (3000K - 70CRI)			40K (4000K - 70CRI)			50K (5000K - 70CRI)			System Watts	TRA (590nm)		
				LUMENS	LPW	BUG RATING	LUMENS	LPW	BUG RATING	LUMENS	LPW	BUG RATING	LUMENS	LPW	BUG RATING		LUMENS	LPW	BUG RATING
48	175	26.4	II	2853	108	B1-U0-G1	3080	117	B1-U0-G1	3242	123	B1-U0-G1	3404	129	B1-U0-G1	21.0	1057	50	B0-U0-G0
			II-FR	2755	104	B1-U0-G1	2974	113	B1-U0-G1	3131	119	B1-U0-G1	3287	125	B1-U0-G1		1021	49	B0-U0-G0
			III-M	2918	111	B1-U0-G1	3150	119	B1-U0-G1	3315	126	B1-U0-G1	3481	132	B1-U0-G1		1081	51	B0-U0-G0
			III-W	2700	102	B1-U0-G1	2914	110	B1-U0-G1	3068	116	B1-U0-G1	3221	122	B1-U0-G1		1000	48	B0-U0-G1
			IV	2937	111	B1-U0-G1	3170	120	B1-U0-G1	3337	126	B1-U0-G1	3504	133	B1-U0-G1		1088	52	B0-U0-G0
			IV-FT	2613	99	B1-U0-G1	2821	107	B1-U0-G1	2970	112	B1-U0-G1	3118	118	B1-U0-G1		968	46	B0-U0-G1
			VSQ-N	3025	115	B2-U0-G0	3266	124	B2-U0-G0	3437	130	B2-U0-G0	3609	137	B2-U0-G0		1121	53	B1-U0-G0
			VSQ-M	3056	116	B2-U0-G1	3298	125	B2-U0-G1	3472	132	B2-U0-G1	3646	138	B2-U0-G1		1132	54	B1-U0-G0
			VSQ-W	2961	112	B2-U0-G1	3196	121	B2-U0-G1	3365	127	B3-U0-G1	3533	134	B3-U0-G1		1097	52	B1-U0-G1
			II-HS	2142	81	B0-U0-G1	2312	88	B0-U0-G1	2433	92	B0-U0-G1	2554	97	B0-U0-G1		793	38	B0-U0-G0
			II-FR-HS	2119	80	B0-U0-G0	2287	87	B0-U0-G0	2407	91	B0-U0-G0	2527	96	B0-U0-G0		785	37	B0-U0-G0
			III-M-HS	2184	83	B0-U0-G1	2357	89	B0-U0-G1	2481	94	B0-U0-G1	2605	99	B0-U0-G1		809	39	B0-U0-G0
			III-W-HS	2135	81	B0-U0-G1	2304	87	B0-U0-G1	2426	92	B0-U0-G1	2547	96	B0-U0-G1		791	38	B0-U0-G1
			IV-HS	2270	86	B0-U0-G1	2451	93	B0-U0-G1	2580	98	B0-U0-G1	2708	103	B0-U0-G1		841	40	B0-U0-G1
			IV-FT-HS	2133	81	B0-U0-G1	2302	87	B0-U0-G1	2424	92	B0-U0-G1	2545	96	B0-U0-G1		790	38	B0-U0-G1
			48	350	52.8	II	5188	98	B1-U0-G1	5600	106	B2-U0-G1	5895	112	B2-U0-G1		6190	117	B2-U0-G1
II-FR	5009	95				B1-U0-G1	5408	102	B1-U0-G1	5693	108	B1-U0-G1	5977	113	B1-U0-G1	1856	45	B1-U0-G0	
III-M	5304	100				B1-U0-G1	5726	108	B2-U0-G2	6028	114	B2-U0-G2	6329	120	B2-U0-G2	1965	48	B1-U0-G1	
III-W	4908	93				B1-U0-G2	5298	100	B1-U0-G2	5577	106	B1-U0-G2	5856	111	B1-U0-G2	1818	44	B1-U0-G1	
IV	5340	101				B1-U0-G1	5764	109	B2-U0-G2	6068	115	B2-U0-G2	6371	121	B2-U0-G2	1978	48	B1-U0-G1	
IV-FT	4752	90				B1-U0-G2	5129	97	B1-U0-G2	5399	102	B1-U0-G2	5669	107	B1-U0-G2	1760	43	B0-U0-G1	
VSQ-N	5500	104				B2-U0-G1	5937	112	B2-U0-G1	6249	118	B2-U0-G1	6562	124	B2-U0-G1	2037	50	B1-U0-G0	
VSQ-M	5555	105				B3-U0-G1	5997	114	B3-U0-G1	6313	120	B3-U0-G1	6628	126	B3-U0-G1	2058	50	B1-U0-G0	
VSQ-W	5383	102				B3-U0-G2	5811	110	B3-U0-G2	6117	116	B3-U0-G2	6423	122	B3-U0-G2	1994	49	B2-U0-G1	
II-HS	3893	74				B0-U0-G1	4202	80	B1-U0-G1	4424	84	B1-U0-G1	4644	88	B1-U0-G1	1442	35	B0-U0-G0	
II-FR-HS	3852	73				B0-U0-G1	4158	79	B0-U0-G1	4377	83	B0-U0-G1	4596	87	B0-U0-G1	1427	35	B0-U0-G0	
III-M-HS	3970	75				B0-U0-G1	4286	81	B0-U0-G2	4511	85	B0-U0-G2	4736	90	B0-U0-G2	1471	36	B0-U0-G0	
III-W-HS	3881	74				B0-U0-G2	4189	79	B0-U0-G2	4410	84	B0-U0-G2	4630	88	B0-U0-G2	1438	35	B0-U0-G1	
IV-HS	4127	78				B0-U0-G1	4456	84	B0-U0-G1	4690	89	B0-U0-G2	4924	93	B0-U0-G2	1529	37	B0-U0-G0	
IV-FT-HS	3878	73				B0-U0-G2	4186	79	B0-U0-G2	4407	83	B0-U0-G2	4627	88	B0-U0-G2	1437	35	B0-U0-G1	
48	525	79.2				II	7366	93	B2-U0-G2	7952	100	B2-U0-G2	8371	106	B2-U0-G2	8789	111	B2-U0-G2	62.0
			II-FR	7113	90	B1-U0-G1	7679	97	B1-U0-G1	8083	102	B2-U0-G1	8487	107	B2-U0-G1	2150	35	B1-U0-G0	
			III-M	7532	95	B2-U0-G2	8131	103	B2-U0-G2	8559	108	B2-U0-G2	8987	113	B2-U0-G2	2277	37	B1-U0-G1	
			III-W	6969	88	B1-U0-G2	7524	95	B1-U0-G2	7920	100	B2-U0-G2	8315	105	B2-U0-G2	2107	34	B1-U0-G1	
			IV	7582	96	B2-U0-G2	8185	103	B2-U0-G2	8616	109	B2-U0-G2	9047	114	B2-U0-G2	2292	37	B1-U0-G1	
			IV-FT	6747	85	B1-U0-G2	7283	92	B1-U0-G2	7667	97	B1-U0-G2	8050	102	B1-U0-G2	2039	33	B0-U0-G1	
			VSQ-N	7809	99	B3-U0-G1	8430	106	B3-U0-G1	8874	112	B3-U0-G1	9317	118	B3-U0-G1	2360	38	B1-U0-G0	
			VSQ-M	7888	100	B3-U0-G2	8515	108	B3-U0-G2	8964	113	B3-U0-G2	9412	119	B3-U0-G2	2384	38	B2-U0-G1	
			VSQ-W	7644	97	B3-U0-G2	8252	104	B3-U0-G2	8687	110	B4-U0-G2	9121	115	B4-U0-G2	2311	37	B2-U0-G1	
			II-HS	5528	70	B1-U0-G2	5967	75	B1-U0-G2	6281	79	B1-U0-G2	6595	83	B1-U0-G2	1671	27	B0-U0-G0	
			II-FR-HS	5470	69	B1-U0-G1	5904	75	B1-U0-G1	6215	78	B1-U0-G1	6526	82	B1-U0-G1	1653	27	B0-U0-G0	
			III-M-HS	5637	71	B0-U0-G2	6085	77	B0-U0-G2	6406	81	B1-U0-G2	6726	85	B1-U0-G2	1704	27	B0-U0-G1	
			III-W-HS	5511	70	B0-U0-G2	5949	75	B0-U0-G2	6262	79	B0-U0-G2	6575	83	B1-U0-G2	1666	27	B0-U0-G1	
			IV-HS	5861	74	B0-U0-G2	6327	80	B1-U0-G2	6660	84	B1-U0-G2	6993	88	B1-U0-G2	1772	29	B0-U0-G1	
			IV-FT-HS	5506	70	B0-U0-G2	5944	75	B1-U0-G2	6257	79	B1-U0-G2	6570	83	B1-U0-G2	1664	27	B0-U0-G1	
			48	700	105.6	II	9234	87	B2-U0-G2	9968	94	B2-U0-G2	10493	99	B2-U0-G2	11018	104	B2-U0-G2	
II-FR	8917	84				B2-U0-G1	9626	91	B2-U0-G1	10133	96	B2-U0-G1	10639	101	B2-U0-G1				
III-M	9442	89				B2-U0-G2	10193	97	B2-U0-G2	10729	102	B2-U0-G2	11266	107	B2-U0-G2				
III-W	8736	83				B2-U0-G2	9431	89	B2-U0-G2	9927	94	B2-U0-G3	10424	99	B2-U0-G3				
IV	9504	90				B2-U0-G2	10260	97	B2-U0-G2	10801	102	B2-U0-G2	11340	107	B2-U0-G2				
IV-FT	8457	80				B1-U0-G3	9130	86	B1-U0-G3	9611	91	B1-U0-G3	10091	96	B1-U0-G3				
VSQ-N	9789	93				B3-U0-G1	10568	100	B3-U0-G1	11124	105	B3-U0-G1	11680	111	B3-U0-G1				
VSQ-M	9888	94				B3-U0-G2	10675	101	B4-U0-G2	11237	106	B4-U0-G2	11798	112	B4-U0-G2				
VSQ-W	9582	91				B4-U0-G2	10344	98	B4-U0-G2	10889	103	B4-U0-G3	11433	108	B4-U0-G3				
II-HS	6929	66				B1-U0-G2	7480	71	B1-U0-G2	7874	75	B1-U0-G2	8267	78	B1-U0-G2				
II-FR-HS	6856	65				B1-U0-G1	7401	70	B1-U0-G1	7791	74	B1-U0-G1	8180	77	B1-U0-G1				
III-M-HS	7066	67				B1-U0-G2	7628	72	B1-U0-G2	8030	76	B1-U0-G2	8431	80	B1-U0-G2				
III-W-HS	6908	65				B1-U0-G2	7457	71	B1-U0-G2	7850	74	B1-U0-G2	8242	78	B1-U0-G2				
IV-HS	7347	70				B1-U0-G2	7931	75	B1-U0-G2	8348	79	B1-U0-G2	8766	83	B1-U0-G2				
IV-FT-HS	6902	65				B1-U0-G2	7451	71	B1-U0-G2	7844	74	B1-U0-G2	8236	78	B1-U0-G2				
48	875	132.0				II	11101	84	B2-U0-G2	11984	91	B2-U0-G2	12615	96	B2-U0-G2	13246	100	B2-U0-G2	N/A
			II-FR	10720	81	B2-U0-G1	11573	88	B2-U0-G1	12182	92	B2-U0-G1	12791	97	B2-U0-G1				
			III-M	11351	86	B2-U0-G2	12254	93	B2-U0-G2	12899	98	B2-U0-G2	13544	103	B2-U0-G2				
			III-W	10503	80	B2-U0-G3	11338	86	B2-U0-G3	11935	90	B2-U0-G3	12532	95	B2-U0-G3				
			IV	11427	87	B2-U0-G2	12335	93	B2-U0-G2	12985	98	B2-U0-G2	13634	103	B2-U0-G2				
			IV-FT	10168	77	B2-U0-G3	10977	83	B2-U0-G3	11555	88	B2-U0-G3	12132	92	B2-U0-G3				
			VSQ-N	11769	89	B3-U0-G1	12705	96	B3-U0-G1	13374	101	B3-U0-G1	14042	106	B3-U0-G1				
			VSQ-M	11888	90	B4-U0-G2	12834	97	B4-U0-G2	13509	102	B4-U0-G2	14184	107	B4-U0-G2				
			VSQ-W	11520	87	B4-U0-G3	12436	94	B4-U0-G3	13091	99	B4-U0-G3	13746	104	B4-U0-G3				
			II-HS	8331	63	B1-U0-G2	8993	68	B1-U0-G2	9467	72	B1-U0-G2	9940	75	B1-U0-G2				
			II-FR-HS	8243	62	B1-U0-G1	8898	67	B1-U0-G1	9367	71	B1-U0-G1	9835	75	B1-U0-G1				
			III-M-HS	8496	64	B1-U0-G2	9171	69	B1-U0-G2	9654	73	B1-U0-G2	10137	77	B1-U0-G2				
			III-W-HS	8305	63	B1-U0-G2	8965	68	B1-U0-G2	9437	71	B1-U0-G2	9909	75	B1-U0-G2				
			IV-HS	8833	67	B1-U0-G2	9535	72	B1-U0-G2	10037	76	B1-U0-G2	10539	80	B1-U0-G2				
			IV-FT-HS	8299	63	B1-U0-G2	8959	68	B1-U0-G3	9430	71	B1-U0-G3	9902	75	B1-U0-G3				

IES File downloads for this product can be found at www.usaltg.com/downloads/asr.html

SIG SERIES - LED

PHOTOMETRIC DATA GUIDE - ISOFOOTCANDLE TEMPLATES

SIG18-PLED-AL-36LED-700mA-40K - 16' Height (14' Pole)

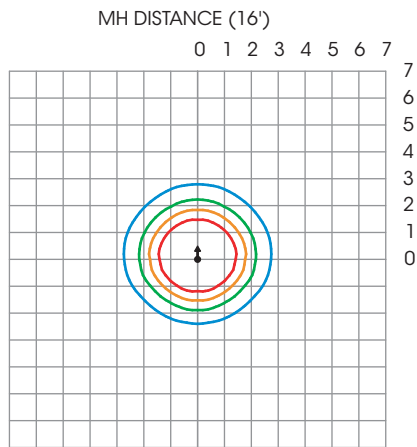

TYPE AL-ASY

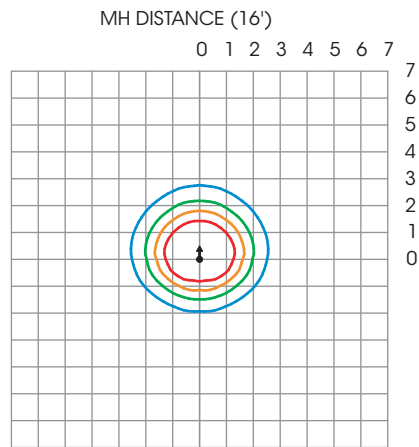

TYPE AL-ASY + HS

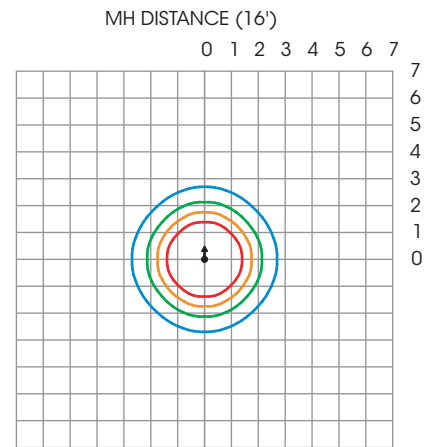

TYPE AL-SYM

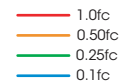

SIG23-PLED-AL-48LED-875mA-40K - 20' Height (18' Pole)

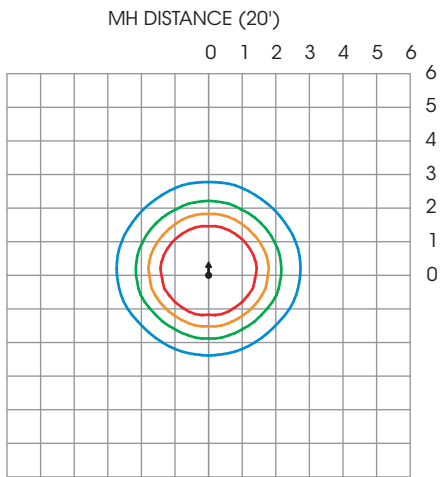

TYPE AL-ASY

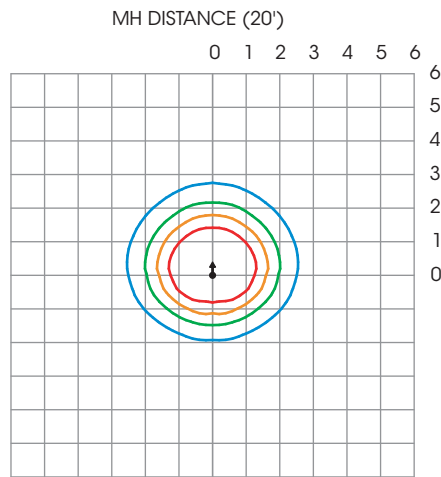

TYPE AL-ASY + HS

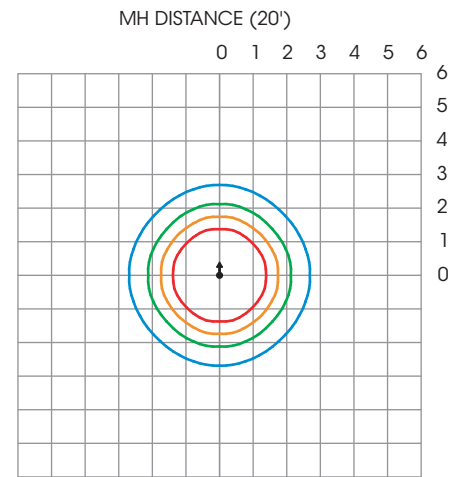

TYPE AL-SYM



IES File downloads for this product can be found at www.usaltg.com/downloads/asr.html

SIG SERIES - LED

PHOTOMETRIC DATA GUIDE - LUMEN TABLES (SIG18-PLED-AL)

SIG18-PLED-AL																			
LED Count	Drive Current (mA)	System Watts	Dist'n Type	27K (2700K - 70CRI)			30K (3000K - 70CRI)			40K (4000K - 70CRI)			50K (5000K - 70CRI)			System Watts	TRA (590nm)		
				LUMENS	LPW	BUG RATING	LUMENS	LPW	BUG RATING	LUMENS	LPW	BUG RATING	LUMENS	LPW	BUG RATING		LUMENS	LPW	BUG RATING
36	175	19.8	ASY	1492	75	B1-U0-G1	1610	81	B1-U0-G1	1695	86	B1-U0-G1	1780	90	B1-U0-G1	16.0	610	38	B0-U0-G0
			SYM	1489	75	B1-U0-G0	1608	81	B1-U0-G0	1692	85	B1-U0-G0	1777	90	B1-U0-G1		609	38	B0-U0-G0
			ASY-HS	1077	54	B0-U0-G0	1162	59	B1-U0-G0	1224	62	B1-U0-G0	1285	65	B1-U0-G0		440	28	B0-U0-G0
36	350	39.6	ASY	2712	68	B1-U0-G1	2928	74	B1-U0-G1	3082	78	B1-U0-G1	3236	82	B1-U0-G1	30.8	1005	33	B1-U0-G0
			SYM	2708	68	B1-U0-G1	2923	74	B1-U0-G1	3077	78	B1-U0-G1	3231	82	B1-U0-G1		1003	33	B1-U0-G0
			ASY-HS	1958	49	B1-U0-G1	2114	53	B1-U0-G1	2225	56	B1-U0-G1	2336	59	B1-U0-G1		725	24	B0-U0-G0
36	525	59.4	ASY	3906	66	B1-U0-G1	4216	71	B2-U0-G1	4438	75	B2-U0-G1	4660	78	B2-U0-G1	46.5	1181	25	B1-U0-G0
			SYM	3899	66	B2-U0-G1	4209	71	B2-U0-G1	4431	75	B2-U0-G1	4652	78	B2-U0-G1		1179	25	B1-U0-G0
			ASY-HS	2819	47	B1-U0-G1	3043	51	B1-U0-G1	3203	54	B1-U0-G1	3364	57	B1-U0-G1		852	18	B0-U0-G0
36	700	79.2	ASY	4953	63	B2-U0-G1	5346	68	B2-U0-G1	5628	71	B2-U0-G1	5909	75	B2-U0-G1	N/A	N/A		
			SYM	4944	62	B2-U0-G1	5337	67	B2-U0-G1	5618	71	B2-U0-G1	5899	74	B2-U0-G1		N/A		
			ASY-HS	3575	45	B1-U0-G1	3859	49	B1-U0-G1	4063	51	B1-U0-G1	4265	54	B1-U0-G1		N/A		
36	875	99.0	ASY	5671	57	B2-U0-G1	6122	62	B2-U0-G2	6445	65	B2-U0-G2	6767	68	B2-U0-G2	N/A	N/A		
			SYM	5662	57	B2-U0-G1	6112	62	B2-U0-G1	6434	65	B2-U0-G1	6755	68	B2-U0-G1		N/A		
			ASY-HS	4094	41	B1-U0-G1	4419	45	B1-U0-G1	4652	47	B1-U0-G1	4884	49	B1-U0-G1		N/A		

PHOTOMETRIC DATA GUIDE - LUMEN TABLES (SIG23-PLED-AL)

SIG23-PLED-AL																			
LED Count	Drive Current (mA)	System Watts	Dist'n Type	27K (2700K - 70CRI)			30K (3000K - 70CRI)			40K (4000K - 70CRI)			50K (5000K - 70CRI)			System Watts	TRA (590nm)		
				LUMENS	LPW	BUG RATING	LUMENS	LPW	BUG RATING	LUMENS	LPW	BUG RATING	LUMENS	LPW	BUG RATING		LUMENS	LPW	BUG RATING
48	175	27.0	ASY	1989	74	B1-U0-G1	2147	80	B1-U0-G1	2260	84	B1-U0-G1	2373	88	B1-U0-G1	21.0	814	39	B0-U0-G0
			SYM	1986	74	B1-U0-G1	2144	79	B1-U0-G1	2257	84	B1-U0-G1	2369	88	B1-U0-G1		812	39	B1-U0-G0
			ASY-HS	1436	53	B1-U0-G1	1550	57	B1-U0-G1	1631	60	B1-U0-G1	1713	63	B1-U0-G1		587	28	B0-U0-G0
48	350	52.5	ASY	3616	69	B1-U0-G1	3904	74	B1-U0-G1	4109	78	B2-U0-G1	4315	82	B2-U0-G1	41.0	1340	33	B1-U0-G1
			SYM	3610	69	B2-U0-G1	3897	74	B2-U0-G1	4103	78	B2-U0-G1	4308	82	B2-U0-G1		1337	33	B1-U0-G0
			ASY-HS	2610	50	B1-U0-G1	2818	54	B1-U0-G1	2966	56	B1-U0-G1	3114	59	B1-U0-G1		967	24	B0-U0-G0
48	525	79.0	ASY	5208	66	B2-U0-G1	5622	71	B2-U0-G1	5918	75	B2-U0-G2	6213	79	B2-U0-G2	62.0	1574	25	B1-U0-G1
			SYM	5199	66	B2-U0-G1	5612	71	B2-U0-G1	5907	75	B2-U0-G1	6203	79	B2-U0-G1		1571	25	B1-U0-G0
			ASY-HS	3759	48	B1-U0-G1	4058	51	B1-U0-G1	4271	54	B1-U0-G1	4485	57	B1-U0-G1		1136	18	B0-U0-G0
48	700	105.1	ASY	6603	63	B2-U0-G2	7128	68	B2-U0-G2	7504	71	B2-U0-G2	7879	75	B2-U0-G2	N/A	N/A		
			SYM	6592	63	B2-U0-G1	7116	68	B2-U0-G1	7491	71	B2-U0-G1	7866	75	B2-U0-G1		N/A		
			ASY-HS	4767	45	B1-U0-G1	5146	49	B1-U0-G1	5417	52	B2-U0-G1	5687	54	B2-U0-G1		N/A		
48	875	131.8	ASY	7562	57	B2-U0-G2	8163	62	B2-U0-G2	8593	65	B2-U0-G2	9023	68	B2-U0-G2	N/A	N/A		
			SYM	7549	57	B2-U0-G1	8149	62	B2-U0-G1	8578	65	B3-U0-G1	9007	68	B3-U0-G1		N/A		
			ASY-HS	5458	41	B2-U0-G1	5892	45	B2-U0-G1	6203	47	B2-U0-G1	6512	49	B2-U0-G1		N/A		

IES File downloads for this product can be found at www.usaltg.com/downloads/asr.html

TYPE L: 20'0" POLE HEIGHT

Luminaire Schedule								
Scenario: L3								
Symbol	Qty	Label	Arrangement	Manufacturer	Description	Luminaire Lumens	Luminaire Watts	LLF
	8	L3W	Single	SUN VALLEY LIGHTING	SIG23-PLED-III-W-48LED-875mA-40K	11835	132	0.920

Calculation Summary							
Scenario: L3							
Label	CalcType	Units	Avg	Max	Min	Avg/Min	Max/Min
Site	Illuminance	Fc	1.4	3.0	0.3	4.7	10.0

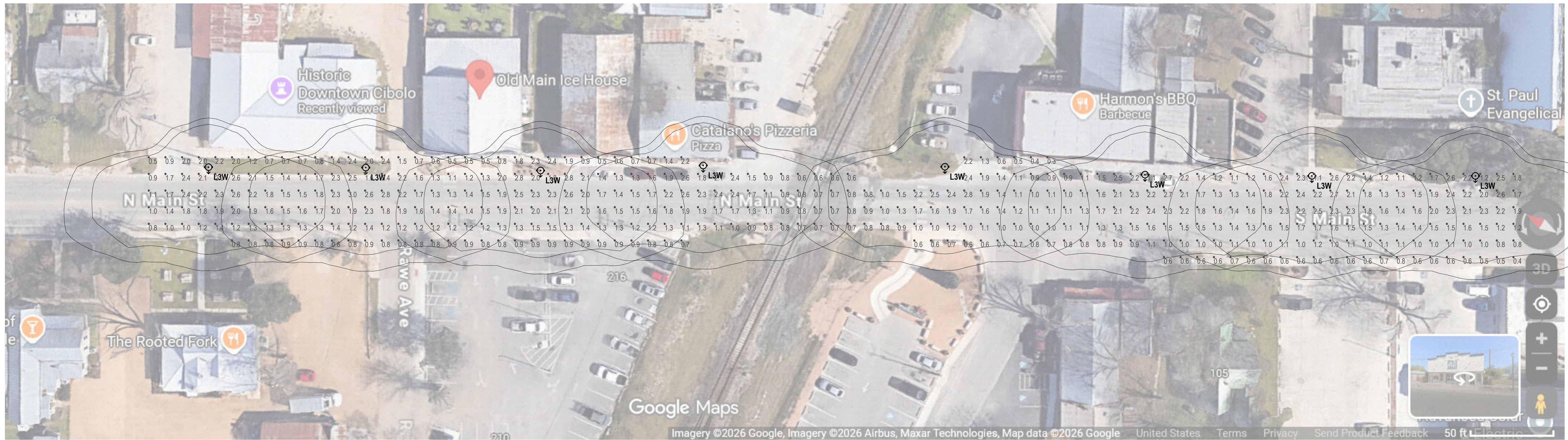

NOTES:
 See schedule for luminaire specifications.
 Luminaire Symbols are not to scale.
 Varying the position, mounting height,
 or orientation from what is specified in this
 drawing will invalidate the calculation performed.

DRAWN BY: L.C.P.
 AGENCY: 2M Lighting + Controls
 Date: 2/25/2026
 SCALE: 1" = 30'0"

Point-By-Point Illuminance Calculation
 (At Grade)
 Cibolo - Main St

MEMO TO COUNCIL

From: Councilwoman Summer-Marie Brown-Ellis & Mayor Kara Latimore

Date: April 14, 2026

Subject: Council-Appointed Employee Evaluation System – Review, Transparency, and Consideration

Council,

We are formally presenting for your review and consideration a newly developed evaluation system for Council-appointed positions. This item is being placed on the public agenda to ensure full transparency and visibility to the community regarding how performance is evaluated for these critical leadership roles.

This approach represents a more structured, consistent, and accountable framework than prior processes and reflects our commitment to strengthening governance and public trust.

Purpose and Framework

The proposed evaluation system is designed to ensure that all Council-appointed roles are evaluated through a process that is:

- Aligned with City Charter responsibilities (CR)
- Grounded in job descriptions and required duties (JD)
- Based on measurable, objective performance metrics
- Consistent across all Council-appointed positions
- Transparent, structured, and defensible

The roles included in this evaluation system are:

- City Manager
- City Attorney
- City Secretary
- City Judge

This framework ensures that evaluations are not based on perception, but on clearly defined expectations tied to both legal responsibilities and professional performance standards.

Commitment to Transparency

This evaluation system is intentionally being introduced in a public setting to:

- Provide clear visibility to residents on how leadership performance is assessed
- Reinforce accountability for Council-appointed positions
- Establish a repeatable and transparent process for future evaluation cycles

This marks a significant step forward in ensuring that our processes reflect the level of responsibility and public investment entrusted to these roles.

Evaluation Process Overview

- Self & Peer-Assessments: Currently in progress (see below, Leadership Self & Peer Assessment Evaluation Model)
- Council Scoring Period: To follow completion of self-assessments
- Compilation of Results: Staff will compile individual Council evaluations
- Final Evaluation Discussion: To be scheduled following compilation

Councilmembers are asked to review the proposed timeline and process and provide direction to ensure alignment and efficiency.

Each Councilmember will complete evaluations independently, ensuring an objective and balanced assessment.

Evaluation Tools and Discussion Format

- A matrix-based evaluation discussion tool has been developed for each position
- Each section includes clear guidance and scoring criteria
- The Mayor Latimer and Councilwoman Brown-Ellis will provide an overview of the tool and facilitate discussion

These tools are designed to keep the process focused, consistent, and aligned with expectations.

Request for Review and Input

All attached materials are working drafts.

We respectfully request that Councilmembers:

- Review all documents thoroughly
- Provide feedback and recommended edits
- Mark up documents as needed for refinement

Our goal is to review the timeline and finalize a strong, standardized evaluation system that can be used consistently moving forward.

Given the significance of these roles and their impact on our community, it is essential that we implement a clear, objective, and transparent evaluation process.

Purpose & Intent of the Leadership Evaluation Model

We are developing a **structured, multi-layered evaluation framework** for Council-appointed positions (City Manager, City Attorney, City Secretary, and City Judge) to strengthen accountability, alignment, and overall leadership effectiveness across the City.

The goal is to move beyond a traditional single-source evaluation model and implement a **comprehensive, governance-driven approach** that provides Council with a more complete and accurate picture of executive leadership performance.

What We Are Trying to Achieve

We are establishing an evaluation system that:

1. Strengthens Executive Leadership Alignment

Ensures that key appointed officials are not operating in silos, but are effectively collaborating to support City operations, policy execution, and service delivery.

2. Provides Council with 360-Degree Insight

Equips Council with multiple perspectives on leadership performance, including:

- Direct Council oversight (primary evaluation)
- Peer leadership interaction (how executive leaders work with one another)
- Department-level leadership effectiveness (how each leader manages their function)

3. Increases Accountability and Transparency

Creates a standardized, metric-based system that ties performance to:

- Charter responsibilities (CR)
- Job descriptions (JD)
- Leadership behaviors and execution

4. Identifies Gaps Early

Allows Council to proactively identify:

- Communication breakdowns
- Operational bottlenecks
- Misalignment between leadership roles
- Risks to effective governance

Key Component: Peer Leadership Assessment (Supplemental)

As part of this model, we are introducing a **Peer Leadership Assessment** component.

This is designed to evaluate how Council-appointed officials:

- Communicate with one another
- Collaborate on City priorities

- Support operational execution
- Demonstrate professionalism and judgment in cross-functional leadership

Important Distinction:

This is **not** an evaluation of each other's authority, legal opinions, or job functions. It is strictly focused on **leadership effectiveness, coordination, and working relationships**.

How the Model is Structured

The evaluation framework will include three components:

- 1. Council Evaluation (Primary and Controlling)**
 - Conducted by City Council
 - Carries the majority weight in overall performance assessment
- 2. Peer Leadership Assessment (Supplemental)**
 - Confidential, structured feedback between appointed officials
 - Focused on collaboration, communication, and leadership interaction
- 3. Department Leadership Feedback (Supplemental)**
 - Evaluates internal leadership, responsiveness, and team management

Guiding Principles for Implementation

To ensure integrity and effectiveness, the system will be:

- **Structured and standardized** (no informal or subjective-only input)
- **Evidence-based** (requiring examples to support ratings)
- **Confidential where appropriate** (particularly peer feedback)
- **Clearly weighted** to preserve Council authority
- **Aligned to Charter and job descriptions** for defensibility

Desired Outcome

The end result is a **clear, consistent, and defensible evaluation process** that:

- Improves leadership performance
- Strengthens collaboration across executive roles
- Supports better decision-making by Council
- Enhances overall City operations and service delivery

Summer

MUNICIPAL COURT JUDGE PERFORMANCE EVALUATION

(Ord. 1267 Requirements + Performance-Based Evaluation)

CATEGORY 1 — LEGAL QUALIFICATIONS & APPOINTMENT COMPLIANCE

Provided to Council to verify (credentialling).

- Maintains status as licensed attorney in good standing
- Meets residency and citizenship requirements
- Maintains required legal experience qualifications
- Serves within appointed term and conditions set by Council

Notes:

Key test: Does the Judge meet all legal requirements to serve?

CATEGORY 2 — JUDICIAL CONDUCT & COURTROOM MANAGEMENT

Provided to Council and peer reviewed by City Secretary/Attorney.

- Conducts court proceedings with professionalism and decorum
- Maintains impartiality and independence in judicial decisions
- Applies laws consistently and appropriately
- Controls courtroom effectively and maintains order
- Treats all participants with fairness and respect

Notes:

Key test: Are proceedings fair, consistent, and professionally conducted?

CATEGORY 3 — COURT OPERATIONS & ADMINISTRATION

Provided to Council and peer reviewed by City Secretary.

- Court sessions are held regularly and begin on time
- Cases are processed in a timely and efficient manner
- Court operations are organized and function effectively
- Demonstrates consistency in courtroom procedures
- Encourages and supports staff training and development
- Maintains awareness of changes in applicable laws

Notes:

Key test: Is the court operating efficiently and consistently?

CATEGORY 4 — COMPLIANCE, RECORDS & LEGAL OVERSIGHT

Provided to Council and peer review City Secretary.

- _____ Court processes comply with applicable laws
- _____ Records are maintained accurately and completely
- _____ Warrants, judgments, and orders are issued appropriately
- _____ Oversight of fines and collections aligns with requirements
- _____ Court operations would withstand audit or legal review

Notes:

Supported by City Secretary Evaluation

Key test: Is the court operating in full compliance?

CATEGORY 5 — COMMUNICATION & COORDINATION

Provided to council and peer reviewed City Secretary.

- _____ Communicates effectively with Police Department and Prosecutor
- _____ Provides clear and accurate rulings and instructions
- _____ Written documentation is clear and complete
- _____ Coordinates effectively with court staff

Notes:

Supported by City Secretary Evaluation

Key test: Does communication support effective court operations?

SCORING SCALE

Score Meaning

- 5 Exceeds expectations with measurable results
- 4 Above average
- 3 Meets expectations
- 2 Below expectations

Score Meaning

1 Does not meet expectations

LEGAL SERVICES PERFORMANCE EVALUATION (City Attorney)

(Engagement-Aligned + Role-Based + Service Delivery)

CATEGORY 1 — CITY ATTORNEY (OVERSIGHT & ADVISORY)

Provided to Council and peer review City Manager/Secretary.

- _____ Provides legal guidance that supports council decision-making
- _____ Works collaboratively with elected officials as outlined in engagement
- _____ Performs requested tasks in a timely and complete manner
- _____ Provides clear understanding of legal boundaries and options
- _____ Demonstrates oversight of the City's legal dealings

Notes:

Key test: Is the City receiving clear, collaborative, and complete legal guidance?

CATEGORY 2 — COUNCIL MEETING ATTORNEY (MEETING SUPPORT)

Provided to Council only.

- _____ Attends council meetings prepared and informed on agenda items
- _____ Provides real-time legal guidance during meetings when needed
- _____ Assists with maintaining proper procedure and order
- _____ Supports council with clear and concise legal input
- _____ Follows through on issues raised during meetings

Notes:

Key test: Did council receive effective legal support during meetings?

CATEGORY 3 — MUNICIPAL COURT PROSECUTOR (COURT OPERATIONS)

Provided to Council and peer review to City Secretary, Judge.

- _____ Prepares and manages cases prior to court
- _____ Represents the City effectively in municipal court proceedings
- _____ Coordinates with police, witnesses, and court staff
- _____ Ensures compliance with applicable laws and procedures
- _____ Maintains professionalism and credibility in court

Notes:

Key test: Are cases handled efficiently, correctly, and professionally?

PERFORMANCE STANDARDS PROSECUTOR

1 — Case Readiness -both judge & clerk

Cases are reviewed and prepared prior to court
Minimal continuances due to lack of preparation
Key test: Are cases ready when they reach court?

2 — Court Effectiveness primary judge
Cases are presented clearly and efficiently
Appropriate use of plea agreements and dismissals
Maintains credibility with the judge
Key test: Are cases handled competently and professionally?

3 — Coordination & Communication primarily with court staff or police?
Communicates timely with police and court staff
Identifies issues early (missing evidence, witnesses, etc.)
Works collaboratively to resolve case issues
Key test: Does the process run smoothly because of coordination?

4 — Compliance & Risk Management the judge and then the clerks
Adheres to applicable laws and procedures
Avoids errors that could jeopardize cases
Maintains proper records and documentation
Key test: Are cases handled correctly and defensibly?

5 — Professionalism- judge and staff feed back about problems of the who
Demonstrates professionalism in court and communication
Treats defendants, staff, and officers respectfully
Maintains composure and credibility
Key test: Does conduct reflect well on the City?

CATEGORY 4 — LITIGATION SUPPORT (SPECIALIZED LEGAL MATTERS)

Provided to Council and peer review City Manager.

- _____ Provides clear direction on litigation matters
- _____ Communicates status, risks, and strategy effectively
- _____ Responds timely to litigation-related inquiries
- _____ Coordinates effectively with City staff and decision-makers
- _____ Protects the City's legal and financial interests

Notes:

Key test: Is the City well-informed and protected in litigation matters?

CATEGORY 5 — GENERAL LEGAL SUPPORT (FIRM-WIDE SERVICES)

Provided to Council and peer review City Manager/Secretary

- _____ Provides adequate coverage and availability across services
- _____ Assigns appropriate personnel to tasks based on complexity
- _____ Delivers consistent quality across all legal services
- _____ Communicates clearly across all levels of service
- _____ Demonstrates a collaborative, service-oriented approach

Notes:

Key test: Is the firm providing consistent, reliable legal support?

SCORECARD

Category	Score (1–5)	Comments
-----------------	--------------------	-----------------

City Attorney

Council Meeting Attorney

Prosecutor

Litigation Support

General Legal Support

Overall Score: _____

OVERALL ASSESSMENT

Strengths:

Areas for Improvement:

Expectations Moving Forward:

City of Cibolo

Job Description



Job Details

Job Title:	City Manager		
Reports to:	City Council		
Grade:	41	WC Code:	8810
Employee Type:	Exempt, Full-time	Pay Type:	Salary
Employment Period:	Indefinite	NAICS Code:	921190
Essential/Subject to Recall:	Yes	Skeleton Crew:	No
Department:	City Manager (40)	Original Date:	04/2009
Program/Division:	Administration (00)	Revision Date:	04/2026

Job Summary

The City Manager is the Chief Administrative Office of the City, including planning, organizing and directing the operations of the city. Duties include administering policies established by the City Council and by law; developing and implementing administrative procedures; coordinating and directing all departments and staff operations; selecting, developing, and effectively utilizing staff; and overall supervision of projects, city financing and intergovernmental relationships. This individual works closely with City Council, with policy or advisory boards or a committee appointed by the council, and with the general public; interacts with other city managers, with state-wide organizations and associations, with representatives of governmental agencies at the state and federal levels, and with the news media; and has contact with all city employees.

Aligns employees and service areas with their mission(s), reinforces commitment to their purpose by sharing performance indicators, and drives continuous improvements to deliver superior service delivery. Responsible for developing employees through constructive feedback, performance evaluations, and professional development. Demonstrates fiscal stewardship, with an understanding of budgeting and oversight of public funds.

Promotes and exhibits the City's core values in daily behaviour – Professional Development, Accountability, Respect, Teamwork, and Integrity.

Essential Functions

Essential Functions are not intended to be an exhaustive list of all responsibilities, duties, and skills. They are intended to be accurate summaries of what the job classification involves and what is required to perform it. Employees are responsible for all other duties as assigned.

1. Directs the administrative and operational activities of the City including all facets to include personnel management, policies, procedures and safety.
2. Interprets policies and provides staff direction on policy as well as policy and procedural revisions.
3. Meets with the Mayor and/or Council at regularly scheduled policy and planning sessions or subcommittee meetings.
4. Meets with citizens, developers and community groups and committees.
5. Provides accurate and appropriate information to the news media to keep citizens informed of governmental activities, while maintaining necessary discretion regarding sensitive or confidential matters.
6. Works with potential businesses, industries and developers to encourage their consideration of the City of Cibolo for future relocations or expansions.



Essential Functions

7. Supervises the city's program and administrative functions and provides general leadership and direction, including ensuring that advance planning is conducted for management of the city's future growth and development.
8. Keeps the city council informed on progress in all departments and on any other pertinent matters relating to city operations to enable them to make informed policy decisions.
9. Develops and implements plans for the personnel, financial and program aspects of city operations in accordance with budgetary and other policy direction established by the council.
10. Plans, coordinates, and directs work relating to the preparation of the City Manager's budget.
11. Submits budget recommendations to the council for approval, files budgets with appropriate authorities, and administers approved budget.
12. Directs staff in preparation of City Council meeting agendas and follow-up actions resulting from Council meetings.
13. Demonstrates continuous effort to improve operations, decrease turnaround times, streamline work processes and work cooperatively and jointly to provide quality seamless customer service.
14. Directs the development review process and the implementation of local, state and federal regulations as they pertain to development within the City.
15. Directs project management for the construction of all municipal projects.
16. Counsel and discipline departmental personnel.
17. Assures that departmental operations are performed in concert with all applicable Federal, State and local laws, ordinances, codes and the policies/procedures from the City Council.
18. Prepare, file and present written and oral studies, reports, and recommendations as directed by the City Council and for City, State and federal officials and organizations.
19. Develops and implements city safety and training programs.
20. Provides staff support to boards and commissions; attends and participates in professional group meetings; and stays abreast of new trends and innovations in the field of municipal government.
21. Attends City Council meetings and takes necessary action regarding Council agenda items.
22. Attends Local/State/Federal required courses.
23. Performs other duties as deemed necessary by the City Council.

Essential Functions

KNOWLEDGE, SKILLS, AND ABILITIES:

- A broad knowledge of general management
- A broad knowledge of budgeting procedures and multi-funded financing operations, regulations, guidelines prepared by state and federal agencies on a variety of programs.
- Ability to gather, compile, analyze, and evaluate a variety of data and make sound decisions regarding that data as it applies to providing services.
- A thorough knowledge of all federal, state, and local laws relative to the activities of engineering, building, construction and all facets of municipal government
- Interprets and communicates to other state and federal rules, regulations, and guidelines; and recognize, evaluate, and respond adequately to a variety of policy issues faced by the city.
- Ability to plan, assign and direct the work of a large number of subordinates.
- Ability to provide leadership and make sound decisions in directing the operations of people and equipment under emergency conditions.
- Ability to prepare reports and carry out long-range plans and programs.
- Ability to maintain harmonious relationship with municipal officials and the general public.
- Ability to evaluate the effectiveness of all city departments and to correlate its development with changing conditions in the municipality.
- Communicate effectively in verbal and/or written form; preparing clear, concise and comprehensive reports.
- Properly respond to sensitive inquiries from citizens and government officials

City of Cibolo

Job Description



Job Requirements

MINIMUM QUALIFICATIONS:

- Bachelor's degree in public administration, business administration, or a related field
- At least five years professional experience working for city, state or local government, including three years supervisory experience or any equivalent combination of experience and training which provides knowledge, skills, and abilities.
- Working knowledge of project management and contract administration; working knowledge of capital improvement planning and budgeting.
- Must possess strong management skills.

PREFERRED QUALIFICATIONS:

- Master's degree in public administration, business administration, or a related field

Physical Demands

N (Not Applicable)	Activity is not applicable for this position.
O (Occasionally)	Position requires this activity up to 33% of the time (0 – 2.5+ hrs/day)
F (Frequently)	Position requires this activity from 33% - 66% of the time (2.5 – 5.5+ hrs/day)
C (Constantly)	Position requires this activity more than 66% of the time (5.5+ hrs/day)

	F		Other Physical Requirements:	
Stand	F			
Walk	F		Vision	Near Acuity, Far Acuity
Sit	C		Sense of Sound	Conversations
Manually Manipulate or Grasp	O		Sense of Smell	N/A
Reach Outward	O		Sense of Touch	N/A
Reach Above Shoulder	O		PPE: None	
Climb or Crawl	O			
Squat, Kneel, or Bend	O		Lift/Carry	Less than 10 lbs frequently
Speak	F		Push/Pull	Less than 12 lbs frequently

The work schedule is normally 8 to 5 Monday – Friday and subject to recall. Work is performed primarily in office with some outdoor settings.

The above list of responsibilities is not exhaustive and the jobholder may be required to undertake other duties commensurate with the level of the role, as reasonable requested by their chain of command.

This job description sets out the duties of the post at the time it was drawn up. Such duties may vary from time to time without changing the general character of the duties or level of the responsibility entailed. Such variations are a common occurrence and cannot in themselves justify a reconsideration of the grading of the post.

Approval (Supervisor):

Signature and Date

Applicant/Employee:

Signature and Date

CITY MANAGER PERFORMANCE EVALUATION

(Charter-Aligned + JD-Referenced + Data-Driven Metrics)

Provided to Council only.

Evaluation Period _____

CATEGORY 1 — GOVERNANCE & COUNCIL SUPPORT (CR-HEAVY)

_____ Agenda materials are accurate, complete, and require minimal correction (CR – 4.01(E))

_____ Agenda items include recommendation, fiscal impact, and analysis (CR – 4.01(G,H))

_____ Information is provided equally and timely to all councilmembers (CR)

_____ Council receives decision-ready information (CR/JD)

_____ Council inquiries are responded to timely and clearly (CR – 4.01(G))

_____ Council actions are tracked and followed through to completion (CR – 4.01(J))

Notes:

Key test: *Did council have everything needed to make an informed decision?* If requested additional information, was it provided at a subsequent council mtg or by email.

CATEGORY 2 — STRATEGIC EXECUTION & POLICY IMPLEMENTATION (CR CORE)

_____ Council decisions are implemented consistent with intent (CR)

_____ Council priorities are completed or advanced (CR – Administer affairs)

_____ Strategic plan milestones are completed on schedule (CR – 4.01(B))

_____ Annual report is produced and reflects measurable outcomes (CR – 4.01(H))

_____ Problems are identified early and brought forward with solutions (JD)

_____ Policy improvements or alternatives are recommended when needed (CR/JD)

Notes:

Key test: *Are decisions actually being carried out?*

CATEGORY 3 — FINANCIAL MANAGEMENT & STEWARDSHIP (CR REQUIRED)

_____ Debt issuance is timely with design and construction of projects. (CM)

_____ Budget is prepared accurately and aligns with council direction (CR – 4.01(F))

_____ Budget is presented in a clear and understandable format (CR/JD)

_____ Financial reports are delivered regularly and on time, are clear and understandable, and are readily accessible to the public to ensure full financial transparency. (CR – 4.01(G))

- _____ Financial decisions reflect accountability and planning (CR)
- _____ Audit results reflect compliance and oversight (CR)
- _____ Resources are used efficiently and effectively (CR/JD)
- _____ Financial policies are regularly reviewed and updated to ensure compliance with applicable laws, alignment with best practices, and adherence to investment policy standards (e.g., PFIA). The investment policy is reviewed and updated as required. (CR4.01(f))

Notes:

Key test: *Is the city being managed responsibly from a financial standpoint?*

CATEGORY 4 — ORGANIZATIONAL LEADERSHIP & ADMINISTRATION (CR + JD)

- _____ Departments are effectively supervised and meeting performance expectations (CR – 4.01(B))
- _____ Qualified staff are recruited and retained (CR – 4.01(A))
- _____ Staff performance is evaluated regularly and goals are set (CR/JD)
- _____ Delegation is effective while maintaining accountability (CR/JD)
- _____ Operational improvements and efficiencies are implemented (CR/JD)
- _____ Organization is aligned with council priorities (CR/JD)

Notes:

Key test: *Is the organization functioning effectively?*

CATEGORY 5 — COMMUNITY, INFRASTRUCTURE & SERVICE DELIVERY

- _____ Capital projects are delivered on schedule and within budget (CR – 4.01(F))
- _____ City services meet established performance standards (CR – 4.01(C,B))
- _____ Citizen concerns are addressed appropriately (JD)
- _____ Communication with the public is timely and transparent (CR/JD)
- _____ Regional coordination and partnerships are maintained (CR/JD)
- _____ Long-term planning and future needs are addressed (CR/JD)

- _____ The City Manager proactively identifies emerging opportunities and challenges and provides Council with strategic analysis and well-developed recommendations to guide policy decisions.

Notes:

Key test: *Is the city delivering results to the community?*

NARRATIVE EVALUATION (REQUIRED)

Strengths (Results-Based)

Areas for Improvement (Specific & Measurable)

Recommendations for Improvement

Council Priorities for Next Evaluation Period

SCORING SCALE

Score Meaning

- 5 Exceeds expectations with measurable results
- 4 Above average
- 3 Meets expectations
- 2 Below expectations
- 1 Does not meet expectations

FINAL – CITY MANAGER PERFORMANCE SCORECARD (FULLY INTEGRATED)

(Charter + JD + Governance + Outcomes) Evaluation Period: _____

Provided to Council only. Pre-evaluation guide. The purpose of this pre-evaluation guide is to provide City Council with a structured, metrics-based framework to support a unified understanding of evaluation expectations prior to the completion of individual performance evaluations.

This guide is intended solely to facilitate discussion among Council regarding:

- The overall evaluation categories
- The key performance metrics tied to each category
- The alignment of those metrics with the City Charter and applicable job descriptions

The pre-evaluation discussion ensures that Council members have a consistent interpretation of performance standards, expectations, and evaluation criteria before conducting their independent assessments.

Following this discussion, each Council member will complete their evaluation individually. The guide does not direct scoring or influence individual judgment, but instead promotes clarity, consistency, and fairness across all evaluations.

Category 1 – Governance and Council Support (Council Function)

(Most heavily Charter-driven category)

Metric	Measure	Target	Score	CR (Required Duty)	JD (Performance Expectation)
Agenda Accuracy	Items requiring correction	<5%		4.01(E) Prepare agendas	Direct staff prep
Agenda Readiness	% decision-ready items (no missing info)	>90%		4.01(G,H) Advise + report	Provide complete analysis
Information Equity	Same info to all councilmembers	100%		Equal dissemination duty	Professional fairness
Recommendation Quality	Items include clear recommendation	>90%		4.01(H) Recommend actions	Provide alternatives
Policy Decision Support	Council has what it needs to decide *	>90%		4.01(G) Keep advised	Facilitate decisions
Responsiveness	Response time	<48 hrs		4.01(G)	Timely communication

From guidance doc:

Key test: “Did I have everything I needed to make a decision?”

* The City Manager is expected to bring forward to Council complete work products so that Council should not be asked to generate the analysis or policy formation that should originate from the City Manager’s office

Category 2 – Strategic Execution & Policy Implementation

Metric	Measure	Target	Score	CR (Required Duty)	JD (Performance Expectation)
Policy Execution	% of council actions implemented	>90%		Implement council intent	Follow-through
Council Goal Completion	% priorities advanced	>80%		4.01 Administer affairs	Execute direction
Strategic Plan Delivery	Milestones completed	>80%		4.01(B)	Align org to goals
Annual Reporting	Annual report delivered + accurate	100%		4.01(H) Reports	Track performance
Problem Solving	% issues brought w/ solution	>90%		4.01(G)	Anticipate problems
Policy Improvement	# of policy improvements proposed	Increase		4.01(G,H)	Recommend improvements

From evaluation doc:

“Implements governing body actions consistent with intent”

Category 3 – Financial Management & Stewardship

Metric	Measure	Target	Score	CR (Required Duty)	JD (Performance Expectation)
Budget Accuracy	Variance	< 5%		4.01(F)	Budget Fiscal Discipline
Budget Clarity	Budget understandable to council	100%		4.01(G)	Accessible format
Quarterly Reporting	Delivered on time	100%		4.01(G)	Transparency
Financial Accountability	Decisions tied to financial impact & credit rating	100%		4.01(G)	Responsible planning / CM statement
Debt Issuance	Start use within 12 months of issuance	100%		4.01(FG)	Responsible planning / CM statement
Financial Policies	Annual review	100%		4.01 (FG)	Responsible planning / CM statement
Audit Results	Findings	Zero major		4.01(CJ)	Compliance
Resource Efficiency	% cost-effective decisions	Improve		4.01(F)	Effective use of funds

From doc:

“Ensures financial planning and accountability”

Category 4 – Organizational Leadership & Administration

Metric	Measure	Target	Score	CR (Required Duty)	JD (Performance Expectation)
Department Performance	% departments meeting goals	>80%		4.01(B) Supervise	Direct operations
Staffing Effectiveness	Retention of key staff	<10% turnover		4.01(A) Appoint/remove	Recruit/retain
Performance Management	Staff evaluations completed	100%		4.01(B)	Evaluate staff
Delegation Effectiveness	% decisions handled at dept level	Increase		4.01(B)	Empower staff
Operational Improvements	# of improvements implemented	Increase		4.01(J)	Innovation
Organizational Alignment	Departments aligned to priorities	>80%		4.01(B)	Focus org on goals

📄 From doc:

“Encourages initiative, teamwork, and problem-solving”

Category 5 – Community, Infrastructure & Service Delivery

Metric	Measure	Target	Score	CR (Required Duty)	JD (Performance Expectation)
Capital Project Delivery	On schedule	>80%		4.01(F)	CIP management
Service Delivery	KPIs maintained	Meet standards		4.01(C,B)	Service effectiveness
Citizen Responsiveness	Response rate/time	Improve		Administer services	Citizen focus

Metric	Measure	Target	Score	CR (Required Duty)	JD (Performance Expectation)
Regional Coordination	# of partnerships	Increase		4.01(J)	Intergovernmental relations
Public Communication	% major issues communicated	100%		4.01(G)	Transparency
Future Planning	Long-term plans developed	Annual		4.01(G,H)	Strategic planning

From doc:

“Helps council address future needs and long-term trends”

◆ Narrative Guidance for Councilmembers (Evaluation Comments Section)

Instruction:

Councilmembers should ensure that all narrative comments are specific, measurable, and directly tied to the metric being evaluated. Avoid general or subjective language. Each comment should clearly explain what was achieved, how it was measured, and why the selected score is appropriate.

When completing the narrative:

- Reference the metric and target
- Provide specific outcomes or data points
- Explain the level of completion or impact
- Tie the comment directly to the assigned score

Example (Strong vs. Weak)

Weak (Avoid):

“Mr. Cibolo did a good job managing CIP projects.”

Strong (Expected Standard):

“Mrs. Cibolo achieved approximately 90% completion of the Capital Improvement Plan (CIP) milestones for the evaluation period. Of 20 planned projects, 18 were delivered on schedule, with delays in 2 projects due to external contractor constraints. This performance supports a score of [X] based on the 100% completion target.”

Narrative Section (Required – From Your Documents)

Strengths (Results-Based)

- What was completed
- What improved
- What was delivered

Areas for Improvement (Specific + Measurable)

- Where Charter duties are not fully met
- Where council support is incomplete

Recommendations

- What needs to change
- What success looks like next year

Council Priorities (Next Cycle)

- Clear direction
- Measurable expectations

 Matches structure in your evaluation doc

Scoring Standard (Aligned Across All Docs)

Score Meaning

- 5 Exceeds expectations with measurable results
- 4 Often exceeds
- 3 Meets expectations
- 2 Below expectations
- 1 Fails to meet Charter duties

City of Cibolo

Job Description



Job Details			
Job Title:	City Secretary		
Reports to:	City Council		
Grade:	30	WC Code:	8810
Employee Type:	Exempt, Full-time	Pay Type:	Salary
Employment Period:	Indefinite	NAICS Code:	921190
Essential/Subject to Recall:	Yes	Skeleton Crew:	No
Department/Division:	City Secretary	Original Date:	05/2012
Fund:	General	Revision Date:	04/2026

Job Summary
<p>City Secretary is responsible for planning, directing, managing, and overseeing the activities and operations of the City Secretary’s Office, including coordinating municipal elections, maintaining official municipal records, and monitoring publication of all official City notices. Coordinates assigned activities with other City departments and outside agencies and provide highly responsible and complex administrative support to the City Council and the Mayor.</p> <p>Aligns employees and service areas with their mission(s), reinforces commitment to their purpose by sharing performance indicators, and drives continuous improvements to deliver superior service delivery. Responsible for developing employees through constructive feedback, performance evaluations, and professional development. Demonstrates fiscal stewardship, with an understanding of budgeting and oversight of public funds.</p> <p>Promotes and exhibits the City’s core values in daily behaviour – Professional Development, Accountability, Respect, Teamwork, and Integrity.</p>

Essential Functions
<p>Essential Functions are not intended to be an exhaustive list of all responsibilities, duties, and skills. They are intended to be accurate summaries of what the job classification involves and what is required to perform it. Employees are responsible for all other duties as assigned.</p> <ol style="list-style-type: none"> Coordinates the preparation and posting of all meeting agendas and notices, to include the assembly and distribution of meeting agenda packets for City Council, City Boards and Commissions and Committee meetings, in accordance with the Texas Open Meetings Act. Attends meetings transcribing minutes of the proceedings, recording meetings and processing actions taken. Prepares proclamations, ordinances, resolutions, contracts, and certificates and coordinates special presentations and public recognitions. Review Charter duties. Administers the Oath of Office to City officials. Serves as the official Custodian of Records for the City. Certifies, executes, and maintains custody of City seal and official records including ordinances, resolutions, contracts, agreements, leases, deeds and minutes of the City Council, Boards, Commissions and Committees ensuring compliance with State Records Retention Laws. Catalogs and files all City records and oversees the codification of ordinances into the municipal code.



Essential Functions

8. Manages, coordinates and processes all amendments to the City Charter and the City Code of Ordinances. Receives and verifies all petitions for recall of officials, initiatives and referendums. Receives all competitive sealed bids, requests for qualifications and requests for proposals. Reviews and issues alcoholic beverage permits.
9. Coordinates set up of polling places and works with Election Judges to respond to and investigate voting complaints. Ensures the election process is democratic, thoroughly publicized and validated. Provides detailed and accurate election information on the City's website.
10. Responds to open records requests in accordance with the Texas Public Information Act and provides timely and accurate information to internal and external customers in compliance with laws, regulations and policies.
11. Carries out the publication of legal notices, such as notices of public hearings, requests for bids and notices of elections.
12. Manages the development and implementation of department goals, objectives and priorities for each assigned service area; recommends and administers policies and procedures; oversees and participates in the development and administration of the department budget and annual work plan.
13. Provides excellent customer service to internal and external customers. Responds promptly to customer needs and requests. Answers phone calls, emails, letters and addresses customers in a professional, helpful manner by providing accurate and timely information with the ability to resolve problems or refer inquires to correct contact.
14. Performs other duties as assigned by the City Council or City Manager
15. Hold and maintain the seal of the City and affix this seal to all appropriate documents.
16. Authenticate, by signature and seal, and record all ordinances, resolutions and proclamations of the City.
17. Assists City Manager in making operational decisions including interpretation of policy, law, Ordinances, the City Charter, Council guidelines, official procedures, open records, municipal elections, and records management.
18. Responsible for all paperwork pertaining to official business of the City Council, and for implementation of the City's record's management program.
19. Communicates with a variety of officials representing State and County government in order to coordinate activities related to the City Secretary Office.
20. Supervise the work of others through planning, organizing, instructing, motivating and objectively evaluating performance.
21. Supports the relationship between the City of Cibolo and the general public by demonstrating courteous and cooperative behaviour when interacting with citizens, visitors and City staff; maintains confidentiality of work-related issues and City information.
22. Prepares and presents reports and other necessary correspondence at council meetings.
23. Processes all city ordinances, resolutions, contracts, and agreements and any other official city document into Laserfiche.
24. Responsible for updating the City website – agenda packets, meetings, calendar, council, and committee pages.
25. Performs all other duties assigned by City of Cibolo Council and the City of Cibolo City Manager.

Job Requirements

KNOWLEDGE, SKILLS, AND ABILITIES:

- Knowledge and understanding of the mission statement and values of the City of Cibolo City Secretary's Office.
- Knowledge in city organization, operation, policies, and procedures. Municipal government functions, political environments, and confidentiality standards.
- Knowledge in State and federal rules, regulations covering municipal government, open records, public information, records management, elections, open meetings, and administrative law.

City of Cibolo

Job Description



Job Requirements

- Knowledge in Open Government and Public Information State Statutes.
- Knowledge of the organization and functions of municipalities.
- Knowledge and abilities of principles and practices of public administration.
- Knowledge of office management methods, procedures and computerized equipment pertinent to the City Secretary's Office.
- Knowledge in principles and practices of the Public Information Act, record keeping, records retention and records management and of record keeping, records retention, and records management.
- Ability to interpret laws and regulations relating to the work performed by the City Secretary's Office.
- Ability to provide information and organize material in compliance with laws, regulations and policies
- Ability to supervise Elections.
- Ability to administer the provisions of the City Charter, ordinances and State and Federal regulations as they relate to the City Secretary's functions.
- Skill in organizing work independently on multiple assigned tasks/projects, complete assignments within specified deadlines.
- Skills in maintaining composure, and direction and working effectively in a high-pressure environment with changing priorities.
- Skills in demonstrate skills critical for success including sound judgment, critical thinking, ethical behaviour, initiative, decisiveness, flexibility, and planning.
- Skills in researching, studying and applying new information. Dealing tactfully and courteously with the general public and others seeking information about City functions and activities.
- Ability to identify and respond to community and City Council issues, concerns, and needs.

Job Requirements

MINIMUM QUALIFICATIONS:

- Bachelor's degree in public administration, business administration, or a related field AND at least five (5) years of increasingly responsibility experience in a city, state or federal position preferably in municipal administration or related field OR any combination of education and experience that results in the applicable skills, knowledge, and abilities
- Certification as a municipal clerk by the Texas Municipal Clerks Certification Program (TMCCP)
- Notary Public or ability to obtain within thirty (30) days from date of hire
- Valid Texas Class "C" Driver's License

Physical Demands

N (Not Applicable)	Activity is not applicable for this position.		
O (Occasionally)	Position requires this activity up to 33% of the time (0 – 2.5+ hrs/day)		
F (Frequently)	Position requires this activity from 33% - 66% of the time (2.5 – 5.5+ hrs/day)		
C (Constantly)	Position requires this activity more than 66% of the time (5.5+ hrs/day)		
Stand	C	Other Physical Requirements:	
Walk	C	Vision	Near Acuity, Far Acuity
Sit	F	Sense of Sound	Conversations
Manually Manipulate or Grasp	C	Sense of Smell	N/A
Reach Outward	O	Sense of Touch	N/A

City of Cibolo

Job Description



Physical Demands			
Reach Above Shoulder	O		Ability to work indoors
Climb or Crawl	O		
Squat, Kneel, or Bend	F		Lift/Carry Less than 10 lbs frequently
Speak	C		Push/Pull Less than 10 lbs frequently
Working environment is relatively free from unpleasant environmental conditions or hazards. Office environment.			

The above list of responsibilities is not exhaustive and the jobholder may be required to undertake other duties commensurate with the level of the role, as reasonable requested by their chain of command.

This job description sets out the duties of the post at the time it was drawn up. Such duties may vary from time to time without changing the general character of the duties or level of the responsibility entailed. Such variations are a common occurrence and cannot in themselves justify a reconsideration of the grading of the post.

Approval (Supervisor):

Signature and Date

Applicant/Employee:

Signature and Date

CITY SECRETARY PERFORMANCE EVALUATION

(Charter-Aligned + JD-Referenced + Data-Driven Metrics)

Provided to Council only.

CATEGORY 1 — GOVERNANCE & COUNCIL SUPPORT (CR-HEAVY)

- _____ Meeting notices are accurate, complete, and compliant with law (CR – 4.02(A))
- _____ Agenda materials are prepared and posted in accordance with requirements (CR – 4.02(A))
- _____ Meetings are attended and properly supported (CR – 4.02(B))
- _____ Minutes are accurate, complete, and require minimal correction (CR – 4.02(C))
- _____ Official records are properly maintained and accessible (CR – 4.02(D))
- _____ Ordinances, resolutions, and proclamations are authenticated and recorded correctly (CR – 4.02(F))

Notes:

Key test: Are meetings, records, and official actions handled accurately and consistently?

CATEGORY 2 — RECORDS, TRANSPARENCY & COMPLIANCE (CR CORE)

- _____ Public records are maintained in compliance with applicable law (CR – 4.02(D))
- _____ Open records requests are processed accurately and within required timelines (JD)
- _____ Agendas, minutes, and public documents are available and accessible (CR – 4.02(D))
- _____ Legal notices are prepared and published correctly (CR – 4.02(A))
- _____ Records retention and codification processes are maintained (JD)
- _____ Website postings and public information are accurate and up to date (JD)

Notes:

Key test: Is the public able to access accurate and timely information?

CATEGORY 3 — COUNCIL SUPPORT & ADMINISTRATIVE FUNCTION (CR + JD)

- _____ Agenda packets are complete and distributed in a timely manner (CR – 4.02(A))
- _____ Official documents are prepared accurately and consistently (CR – 4.02(F))
- _____ Council inquiries are responded to timely and clearly (CR – 4.02(G))
- _____ Council-directed duties are completed accurately and on time (CR – 4.02(G))
- _____ Reports and correspondence are clear and accurate (JD)
- _____ Meetings are organized and supported effectively (JD)

Notes:

Key test: Does Council receive consistent and reliable administrative support?

CATEGORY 4 — ELECTIONS & STATUTORY DUTIES (CR REQUIRED)

- _____ Elections are scheduled and conducted in compliance with applicable law (CR – 4.02(H))
- _____ Election processes are accurate and properly coordinated (JD)
- _____ Petitions (recall, initiative, referendum) are processed in accordance with requirements (JD)
- _____ Election information is communicated clearly and timely (JD)

Notes:

Key test: Are statutory responsibilities executed with accuracy and compliance?

CATEGORY 5 — ORGANIZATIONAL SUPPORT & OPERATIONS

- _____ Department operations are managed effectively and meet performance expectations (JD)
- _____ Staff are supervised and performance is evaluated appropriately (JD)
- _____ Budget responsibilities are managed within approved limits (JD)
- _____ Customer service is professional, timely, and responsive (JD)
- _____ Coordination with departments and external agencies is effective (JD)
- _____ Operational improvements are identified and implemented when appropriate (JD)

Notes:

Key test: Is the office functioning effectively and supporting the organization?

NARRATIVE EVALUATION (REQUIRED)**Strengths (Results-Based)****Areas for Improvement (Specific & Measurable)****Recommendations for Improvement****Council Priorities for Next Evaluation Period**

SCORING SCALE**Score Meaning**

- 5 Exceeds expectations with measurable results
- 4 Above average
- 3 Meets expectations
- 2 Below expectations
- 1 Does not meet expectations

City Secretary Performance Scorecard

(Charter + Job Description Integrated)

Category 1 – Governance Compliance

Metric	Measure	Target	Score	CR	JD
Meeting Notice Compliance	% properly posted	100%		4.02(A)	#1 Agenda posting & notices
Meeting Attendance	Attendance rate	100%		4.02(B)	#2 Attend meetings
Minutes Accuracy & Timeliness	Errors/corrections	<5%		4.02(C)	#2 Minutes & actions
Records Custodianship	Records maintained	100%		4.02(D)	#6/#7/#19 Records management
Seal & Authentication	Proper execution	100%		4.02(E)	#16 City seal
Ordinance/Resolution Recording	Proper recording	100%		4.02(F)	#17/#24 Document processing
Election Administration	Legal compliance	100%		4.02(H)	#9 Election coordination
Council-Directed Duties	Completion rate	100%		4.02(G)	#15/#26 Assigned duties

Category 2 – Transparency & Public Information

Metric	Measure	Target	Score	CR	JD
Open Records Compliance	Response time	Legal deadlines		4.02(D)	#10 Open records
Public Access to Records	Availability	100%		4.02(D)	#25 Website updates
Legal Notices	Proper publication	100%		4.02(A)	#12 Legal notices

Category 3 – Council Support

Metric	Measure	Target	Score	CR	JD
Agenda Packet Quality	Complete packets	>95%		4.02(A)	#1/#23 Agenda support
Document Preparation	Accuracy	>95%		4.02(F)	#3 Document prep
Council Responsiveness	Response time	<48 hrs		4.02(G)	#14 Customer service

Category 4 – Elections & Statutory Compliance

Metric	Measure	Target	Score	CR	JD
Election Accuracy	Errors	0		4.02(H)	#9 Elections
Petition Processing	Timeliness	100%		4.02(H)	#8 Petitions
Records Retention Compliance	Compliance rate	100%		4.02(D)	#6 Records retention

Category 5 – Operations & Leadership

Metric	Measure	Target	Score	CR	JD
Department Management	Goals achieved	>90%		4.02(G)	#13 Dept management
Staff Oversight	Evaluations completed	100%		4.02(G)	#21 Supervision
Budget Stewardship	Within budget	100%		4.02(G)	#13 Budget oversight
Process Improvement	Improvements/year	≥2		4.02(G)	Continuous improvement

◆ Narrative Guidance for Councilmembers (Evaluation Comments Section)

Instruction:

Councilmembers should ensure that all narrative comments are specific, measurable, and directly tied to the metric being evaluated. Avoid general or subjective language. Each comment should clearly explain what was achieved, how it was measured, and why the selected score is appropriate.

When completing the narrative:

- Reference the metric and target
 - Provide specific outcomes or data points
 - Explain the level of completion or impact
 - Tie the comment directly to the assigned score
-

Example (Strong vs. Weak)

Weak (Avoid):

“Mr. Cibolo did a good job managing CIP projects.”

Strong (Expected Standard):

“Mrs. Cibolo achieved approximately 90% completion of the Capital Improvement Plan (CIP) milestones for

the evaluation period. Of 20 planned projects, 18 were delivered on schedule, with delays in 2 projects due to external contractor constraints. This performance supports a score of [X] based on the 100% completion target.”

Narrative Section (Required – From Your Documents)

Strengths (Results-Based)

- What was completed
- What improved
- What was delivered

Areas for Improvement (Specific + Measurable)

- Where Charter duties are not fully met
- Where council support is incomplete

Recommendations

- What needs to change
- What success looks like next year

Council Priorities (Next Cycle)

- Clear direction
- Measurable expectations

Matches structure in your evaluation doc

◆ Scoring Standard (Aligned Across All Docs)

Score Meaning

- 5 Exceeds expectations with measurable results
- 4 Often exceeds
- 3 Meets expectations
- 2 Below expectations
- 1 Fails to meet Charter duties



City Council Regular Meeting Staff Report

D. Discussion/Action for City Council to approve the FY26 Capital Improvement Program (Mr. Gomez)

Meeting	Agenda Group
Tuesday, April 14, 2026, 6:30 PM	Discussion/Action Item: 11D.
From	
Julio Gomez, Public Works Director	

PRIOR CITY COUNCIL ACTION:

City Council has provided direction through the FY26 Budget adoption and the March 28, 2026 Strategic Management Workshop, where infrastructure priorities and funding strategies were discussed.

BACKGROUND:

The FY26 Capital Improvement Program (CIP) represents the City's continued commitment to maintaining and improving critical infrastructure while supporting responsible growth. The program includes projects across multiple service areas, including streets, parks, facilities, and the police department facility.

Since the Capital Improvement Program was presented to City Council in June and July 2025, several key updates have occurred that have impacted the proposed program. Most notably, the TxDOT FM 1103 contribution of \$3,400,000 has shifted to Fiscal Year 2027, creating additional capacity within Fiscal Year 2026.

In addition, the City pursued funding through the SB 1555 grant program but was not selected. As a result, staff has refocused the FY26 Capital Improvement Program to prioritize projects that can be delivered with available funding and provide immediate benefit to the community.

The updated FY26 Capital Improvement Program places an emphasis on addressing aging facilities, signal light improvements, advancing the design of Wiedner Road, funding for park renovations, and purchasing equipment necessary to maintain service levels for our residents.

Staff developed the FY26 Capital Improvement Program through a comprehensive evaluation process that considered public safety, regulatory requirements, infrastructure condition, community impact, and project readiness. This approach ensures that projects included in the program align with City Council's priorities and provide the greatest benefit to the community.

In addition, staff has coordinated closely with Finance to ensure that the proposed projects are aligned with available funding sources and long-term financial planning. The FY26 Capital Improvement Program also reflects input received from previous council discussions, community engagement efforts, and ongoing operational assessments.

STAFF RECOMMENDATION:

Staff recommends approval of the FY26 Capital Improvement Program as presented.

FINANCIAL IMPACT:

The FY26 Capital Improvement Program will be funded through the issuance of the 2026 Certificate of Obligation Bonds.

Attachments

[FY26 CAPITAL IMPROVEMENT PROGRAM.pdf](#)

[CIP Handouts](#)

	FY26	
BONDING CAPACITY		\$ 4,500,000
FACILITIES	PD AC REPAIR	\$ 500,000
	PD ROOF REPAIR	\$ 250,000
	PD/FIRE RADIO REPLACEMENT	\$ 750,000
CIP PLANNING	WEIDNER RD DESIGN	\$ 1,500,000
ROADS	TRAFFIC SIGNAL IMPROVEMENTS	\$ 150,000
	PAVEMENT CONDITION INDEX SURVEY	\$ 250,000
FLEET	PARKS EQUIPMENT	\$ 70,000
	PAVING MACHINE	\$ 280,000
PARKS	PARK RENOVATIONS	\$ 750,000
TOTALS		\$ 4,500,000

FUNDING CITYWIDE INFRASTRUCTURE PROJECTS

GUIDING PRINCIPLES

The City will:

- Focus on most critical projects first including streets, water, wastewater, and safety
- Balanced Funding Sources using pay-as-you-go funding, when possible, and debt that is within the city's tax rate
- Collect and update impact fees to ensure development pays for growth
- Seek grant partnerships to stretch tax dollars further
- Plan for the long term, ensuring projects fit the city's growth & future needs
- Be good stewards of taxpayer dollars by using tax resources efficiently



PAY AS YOU GO (STREET MAINTENANCE TAX)

Facts to consider:

- We can only spend what we collect each year, big projects may take longer
- We don't borrow money, no interest - saves taxpayers money
- A slower economy means less funding, potentially delay or reduce projects
- Prioritize essential projects (i.e. streets, utilities, & public safety needs)

Examples: Royal Troon (Long Lane Repair, Buffalo Crossing (Preservation), Trailhead Parking Area (Parks))

GENERAL (GO) & CERTIFICATES OF OBLIGATION (CO) BONDS

Facts to consider:

- Helps fund important public projects without delay
- Used for essential infrastructure (i.e. streets, utilities & public buildings)
- Paid back through property taxes, which may impact tax rate
- GO approved by voters, CO approved by City Council
- Both backed by the full faith & credit of the City. May impact I&S portion of the tax rate

CO Examples:

Dean Road, Bolton Road, Lower Seguin Road, Deer Creek Blvd, Town Creek Road

GO Examples:

Fire Station #4, Public Works Building Expansion, Animal Services Facility



DEVELOPMENT IMPACT FEES

Facts to consider:

- Development impact fees ensure that new growth contributes fairly to the cost of the infrastructure needed to support it
- Impact fees fund essential infrastructure projects, like roads, water, and wastewater systems that accommodate expanding communities

GRANTS & PARTNERSHIPS

Federal, State & Local resources that offer opportunities for funding infrastructure & parks projects:

- State & Local Fiscal Recover funds under ARPA
- Texas Parks & Wildlife
- GVEC - Power Up Grant



CITY OF CIBOLO COMPLETED CIP



CITY OF CIBOLO PROPOSED CIP





City Council Regular Meeting Staff Report

E. Discussion/Action to approve an Additional Service Request with EIKON Consulting Group, LLC for professional design services for the Public Safety Facility Project in an amount not to exceed \$150,045 and authorize the City Manager to execute the associated change order for \$150,045. (Mr. Huggins)

Meeting	Agenda Group
Tuesday, April 14, 2026, 6:30 PM	Discussion/Action Item: 11E.
From	
Bryan Huggins, Executive Director - Safety and Infrastructure	

PRIOR CITY COUNCIL ACTION:

- August 22, 2023. - City Council approved the City Manager to negotiate a contract for Engineering/Architectural Design Services with EIKON Consulting Group, LLC for the Public Safety Facility.
- October 10, 2023 - City Council approved the final contract with EIKON Consulting Group, LLC in an amount not to exceed \$805,985.

BACKGROUND:

EIKON Consulting Group, LLC, is currently providing Professional Design Services for the Public Safety Facility/Fire Station No. 4 Project. As the project continues through the design phase, additional professional services have been identified as necessary to advance the project, including:

- Design and incorporate an on-site septic system into the project due to wastewater infrastructure not being available along Bolton Road at the time of construction;
- Extending the east side of the property to improve alignment with the intersection at Stolte Road;
- Modifying the site to accommodate the future right-of-way needed for Bolton Road to be expanded to an arterial roadway, requiring approximately 15 feet on ROW setback for the facility; and
- Eliminating the road from the site to I-10.

STAFF RECOMMENDATION:

City staff recommends approval of the change order with EIKON Consulting Group, LLC for additional professional services for the Public Safety Facility/Fire Station No. 4 design Project, in the amount of \$150,045.

FINANCIAL IMPACT:

In the FY25 General Obligation bond that the City received funding from in March 2025 , there was \$1,000,000 issued for additional design work, surveys, and land acquisition for the Public Safety Facility. The \$150,045 needed for this additional work by EIKON Consulting Group, LLC will come from that FY25 GO Bond funding.

MOTION(S):

Suggested Motion: I move to approve an Additional Service Request with EIKON Consulting Group, LLC, for professional design services for the Public Safety Facility/Fire Station No.4 Project in an amount not to exceed \$150,045 and authorize the City Manager to execute the associated change order for \$150,045.

Attachments

[EIKON Cibolo PSF ASR 001 Additional Design Rev2.pdf](#)



ADDITIONAL SERVICES REQUEST 001

March 31, 2026 Rev2

**City of Cibolo
Wayne Reed, City Manager
200 South Main Street
Cibolo, Texas 78108
210-658-9900
wreed@cibolotx.gov
(Delivered via email)**

**RE: Cibolo Fire Station No.4 #230287
Original Contract Date: 09/15/2023**

To Whom it May Concern:

As requested, EIKON is pleased to submit this proposal for professional design services related to the above referenced project. Our explanation of scope alterations and Fee are outlined below. This proposal addresses out of scope items not previously included or alterations of the completed tasks from the original contract. The scope and fee associated with this proposal will be in addition to the remaining scope and fee to be completed in the original contract. We expect an amendment to the original contract will be executed expanding the original contract to include the additional scope and fee presented within.

Description of Additional Requested Items

We understand that the project's additional services requested includes modifying the site to accommodate the plan for Bolton Road to become a major arterial requiring approximately 15 feet on ROW setback for the facility. We also understand there is a necessity to design and incorporate septic into the project due to the wastewater infrastructure not being installed along Bolton Road. We will design and provide a pipe stubbed out and capped for future connection. The east side of the property will be extended through land acquisition to allow for the intersection to line up the entire length of the property including the detention pond. The facility will be re-centered on the site due to this acquisition. The road extending to the I-10 frontage is no longer needed and will be removed from the project. In order to accomplish the requirements of the septic system the area noted for future training and most likely the associated parking will be utilized. The parking spaces will be relocated on the site. The detention pond will be reconfigured to allow septic lines on each side in addition to possibly adding parking spaces on the north side. The MEP components such as site lighting, electrical and plumbing modifications for septic and future infrastructure connection will be incorporated along with all other associated modifications. EIKON will complete the coordination of all design components, QA/QC processes along with 30% and 90% review meetings with the City. The goal for this project will be to complete the documents, obtain permit approval and issue to bid in approximately June 2026 allowing for the potential completion early 2028.

In addition, it is agreed that the construction administration services will be limited to virtual progress meetings for most of the duration. EIKON and the City will work together as situation

arise that to determine the need for onsite meetings such as key milestones or solution oriented meetings with the contractor upon unforeseen conditions being discovered etc.

Scope of Services (Exhibit A)

Descriptions of Specific Services

Architectural and Structural – Services which may include the following:

Modifications and Re-Design Efforts for all Documents:

- Project Management
- Completion of Documents for Requested/Required Modifications
- Owner Review Meetings at 30% and 90%
- More Comprehensive Bidding Assistance to include Development of Front-End Specification and Advertising Documents, Bid Opening, Review of Bids, Reference Checks of Bidders, Interview and Award Recommendation Documents for Council

Civil – Civil Services to produce Construction Drawings as Required which may include the following:

Modifications and Re-Design Efforts for all Documents:

- Survey of Additional Land to be Acquired
- Landscape Design Modifications
- Existing Conditions and Demolition Plan
- Site and Dimensional Control Plan (Site Plan with Dimensional Control)
- Grading Plan
- Drainage analysis and Plan
- Paving Plan
- Utility Plan
- Recommended Erosion and Sediment Control Plan

Mechanical, Electrical, Plumbing – MEP Services which may include

Modifications and Re-Design Efforts for all Documents:

- Lighting Design
- Power, Signal, and Electrical Distribution Design
- Fire Alarm and Fire Protection Performance Specifications
- Plumbing Design
- Interior lighting, exterior lighting, and mechanical COMcheck

Assumptions

- The City will be responsible for the land acquisition and provide EIKON and any subconsultants with access to perform necessary field work for design and document completion within the requirements of the approved schedule. Re-Platting documents are not included. If necessary it will be an additional service request.

Schedule (Exhibit B)

EIKON will work with the City to complete the permitting and approval processes including developing the required documents to advertise and begin bidding approximately in June 2026.

Fee (Exhibit C)

- **Additional Project Fee** to be based on a percentage of the total construction cost of the building inclusive of all additional scope identified above (to be adjusted at the last billing when the actual costs are determined): $1.25\% \times \text{Construction Costs}$ (construction costs assumed to be approximately \$12M) = \$150,000

Sincerely,

EIKON

CLIENT

By: *Brad Isbell*

By: _____

Name: Brad Isbell

Name: _____

Title: CEO

Title: _____

Date: March 31, 2026

Date: _____

EIKON Cibolo Fire Station #4 Additional Services Request 001 Analysis Rev 2

Task: Site Modification for Bolton Road Major Arterial and Land Acquisition

Scope of Work	Discipline	Hourly Rate	Task Hours	Total
· Rework Site Plan	Architecture			
· Overall Coordination	Principal Architect	\$ 275.00	4	\$ 1,100.00
	Designer	\$ 245.00	7	\$ 1,715.00
	Project Manager	\$ 225.00	67	\$ 15,075.00
	Administrative Assistant	\$ 95.00	2	\$ 190.00
				<u>\$ 18,080.00</u>
· Rework Site Plan/Details	Landscape Architecture			
	Subconsultant - Landprint	\$ 8,500.00	1.15	\$ 9,775.00
				<u>\$ 9,775.00</u>
· Survey of Land Acquired	Survey			
	Subconsultant - Colliers	\$ 3,500.00	1.15	\$ 4,025.00
				<u>\$ 4,025.00</u>
· Rework Site Plan	Civil			
· Rework Paving Plan	Principal Engineer	\$ 275.00	20	\$ 5,500.00
· New Drainage Calcs	Associate Engineer	\$ 185.00	48	\$ 8,880.00
· Rework Grading Plan	Civil Drafter	\$ 135.00	78	\$ 10,530.00
	Administrative Assistant	\$ 95.00	2	\$ 190.00
				<u>\$ 25,100.00</u>
· Rework Site Plan	MEP			
· New Site Lighting	Principal Electrical Engineer	\$ 275.00	12	\$ 3,300.00
· New Photometrics	Associate Electrical	\$ 185.00	26	\$ 4,810.00
· New ComChecks	Electrical Drafter	\$ 135.00	34	\$ 4,590.00
	Administrative Assistant	\$ 95.00	2	\$ 190.00
				<u>\$ 12,890.00</u>
	Task Total			\$ 65,845.00

Task: Septic Design and Preparation for Future Sanitary Sewer

· Incorporate Septic to Site	Architecture			
· Overall Coordination	Principal Architect	\$ 275.00	2	\$ 550.00
	Designer	\$ 245.00	4	\$ 980.00
	Project Manager	\$ 225.00	24	\$ 5,400.00
	Administrative Assistant	\$ 95.00	2	\$ 190.00
				<u>\$ 7,120.00</u>
· Septic Design	Septic			
	Subconsultant - KCB	\$ 3,900.00	1.15	\$ 4,485.00
				<u>\$ 4,485.00</u>

· Incorporate Septic to Site	Civil				
· Design for Future SS	Principal Engineer	\$ 275.00	6	\$	1,650.00
	Associate Engineer	\$ 185.00	18	\$	3,330.00
	Civil Drafter	\$ 135.00	24	\$	3,240.00
	Administrative Assistant	\$ 95.00	2	\$	190.00
					<u>\$ 8,410.00</u>

· Incorporate Septic	MEP				
· Rework Utility Connection	Principal MP Engineer	\$ 275.00	24	\$	6,600.00
· Lift Station Design	Associate Mechanical/Plumbing	\$ 185.00	16	\$	2,960.00
· Design for Future SS	Mechanical/Pumbing Drafter	\$ 135.00	20	\$	2,700.00
	Administrative Assistant	\$ 95.00	4	\$	380.00
	Principal Electrical Engineer	\$ 275.00	10	\$	2,750.00
	Associate Electrical	\$ 185.00	12	\$	2,220.00
	Electrical Drafter	\$ 135.00	24	\$	3,240.00
	Administrative Assistant	\$ 95.00	2	\$	190.00
					<u>\$ 21,040.00</u>

Task Total

\$ 41,055.00

Task: Detention Modification Due to Site Changes and Septic

· Rework Site Plan	Architecture				
· Overall Coordination	Principal Architect	\$ 275.00	1	\$	275.00
	Designer	\$ 245.00	1	\$	245.00
	Project Manager	\$ 225.00	16	\$	3,600.00
	Administrative Assistant	\$ 95.00	1	\$	95.00
					<u>\$ 4,215.00</u>

· Incorporate Septic Lines	Civil				
· Rework Detention Pond	Principal Engineer	\$ 275.00	14	\$	3,850.00
· New Detention Calcs	Associate Engineer	\$ 185.00	22	\$	4,070.00
· Remove South Drive	Civil Drafter	\$ 135.00	54	\$	7,290.00
	Administrative Assistant	\$ 95.00	1	\$	95.00
					<u>\$ 15,305.00</u>

Task Total

\$ 19,520.00

Task: General Coordination and QA/QC Due to Elapsed Time

· Review/Update Codes	Architecture				
· New Specification Items	Principal Architect	\$ 275.00	2	\$	550.00
· Overall Coordination	Designer	\$ 245.00	2	\$	490.00
	Project Manager	\$ 225.00	16	\$	3,600.00
	Administrative Assistant	\$ 95.00	9	\$	855.00
					<u>\$ 5,495.00</u>

· Review/Update Codes	Structural				
· New Specification Items	Principal Engineer	\$ 275.00	2	\$	550.00
· Overall Coordination	Associate Engineer	\$ 185.00	8	\$	1,480.00
	Structural Drafter	\$ 135.00	6	\$	810.00
	Administrative Assistant	\$ 95.00	2	\$	190.00
					<u>\$ 3,030.00</u>

· Review/Update Codes	Civil				
· New Specification Items	Principal Engineer	\$ 275.00	2	\$ 550.00	
· Overall Coordination	Associate Engineer	\$ 185.00	8	\$ 1,480.00	
	Civil Drafter	\$ 135.00	6	\$ 810.00	
	Administrative Assistant	\$ 95.00	2	\$ 190.00	
				<u>\$ 3,030.00</u>	
· Review/Update Codes	MEP				
· New Specification Items	Principal MP Engineer	\$ 275.00	4	\$ 1,100.00	
· Overall Coordination	Associate Mechanical/Plumbing	\$ 185.00	8	\$ 1,480.00	
	Mechanical/Plumbing Drafter	\$ 135.00	4	\$ 540.00	
	Administrative Assistant	\$ 95.00	2	\$ 190.00	
	Principal Electrical Engineer	\$ 275.00	2	\$ 550.00	
	Associate Electrical	\$ 185.00	8	\$ 1,480.00	
	Electrical Drafter	\$ 135.00	4	\$ 540.00	
	Administrative Assistant	\$ 95.00	2	\$ 190.00	
				\$ 6,070.00	
	Review Meetings	Per Trip Cost	Trips		
	One Attending/Others Virtual	\$ 3,000.00	2	\$ 6,000.00	
	Task Total			<u>\$ 23,625.00</u>	
	Total Fee			<u>\$ 150,045.00</u>	