



CITY OF SIERRA MADRE

PLANNING COMMISSION REGULAR MEETING AGENDA

Thursday, May 7, 2026, 5:30 PM

City Council Chambers, 232 W. Sierra Madre Blvd.

AMERICANS WITH DISABILITIES ACT

Pursuant to the Americans with Disabilities Act, persons with a disability who require a disability related modification or accommodation in order to participate in a meeting, including auxiliary aids or services, may request such modification or accommodation from the City Clerk at (626) 574-5455. Notification 48 hours prior to the meeting will enable the City to make reasonable arrangements to assure accessibility to the meeting.

PUBLIC COMMENT & ACCESS

The Brown Act provides the public with an opportunity to make public comments at any public meeting. As an alternative, public comment may be submitted by e-mail to publiccomment@sierramadrecal.gov by 3:00PM on the day of the meeting. Emails will be acknowledged at the Planning Commission meeting, filed into public record, and scanned onto the City website for public review.

A copy of the posted agenda and a live video stream of the meeting can be found on the City's website at sierramadrecal.gov, on Foothills Media website at foothillsmedia.org/sierramadre, and broadcast on Government Access Channel 3 (Spectrum).

If you require special assistance to participate in this meeting, please contact the City Clerk's Office at (626) 355-7135 at least 48 hours prior to the meeting.

CODE OF CONDUCT

The purpose of a Planning Commission meeting is to conduct City business. Members of the public that behave in a manner that interrupts or obstructs the Planning Commission's ability to conduct City business may be asked to leave the meeting. Any and all demonstrations which disrupt, interrupt, or obstruct the Planning Commission's ability to conduct City business are prohibited. No signs, posters, or other large objects shall be brought into the Council Chambers or other meeting place if doing so would disrupt, disturb, or otherwise impede the orderly course of the meeting.

1. CALL TO ORDER

2. ROLL CALL OF PLANNING COMMISSION MEMBERS

Thomas Denison, Chair
Patrick Simcock, Vice Chair,
Kevin Brennan, Commissioner
Christine Moran, Commissioner
Yong Yoo, Commissioner

3. APPROVAL OF AGENDA

4. REPORT FROM CITY COUNCIL LIASON

5. PUBLIC COMMENT FOR ITEMS NOT ON THE AGENDA

Any person wishing to speak before the Planning Commission is asked to complete a Speaker Card and provide it to staff prior to the start of the meeting. Speakers are generally limited to three (3) minutes per person and time may not be delegated; any changes to the allotted time will be announced prior to the Public Comment period. Under the Brown Act, the Planning Commission is prohibited from discussing or taking action on any item not listed on the posted agenda.

Addressing the Planning Commission from the audience is not permitted; all comments addressing the Commission must be made from the podium. Only public comment made from the podium will be recognized by the Planning Commission and entered into public record.

6. PUBLIC HEARING

Any person wishing to speak before the Planning Commission on a public hearing item is asked to complete a Speaker Card noting the agenda item number and provide it to staff prior to the start of the public hearing. Separate and apart from the applicant (who may speak longer in the discretion of the Commission) speakers are generally limited to three (3) minutes per person; any changes to the allotted time will be announced prior to the Public Comment period. Under the Brown Act, the Planning Commission is prohibited from discussing or acting on any item not listed on the posted agenda. The applicant may additionally submit rebuttal comments, at the discretion of the Commission.

Following the closure of the public hearing and prior to the final decision, Commissioners shall disclose any ex parte communication that has taken place pertaining to the public hearing item. Planning Commissioners shall also disclose all visits to a site that is the subject of a quasi-adjudicatory proceeding before the Planning Commission. The disclosure will include whether the site visit was organized by staff, upon the invitation of the applicant, or on the Commissioners' own accord. The Commissioner must disclose all information learned from the site visit that is not included in the agenda packet and that informs his or her decision-making.

- A. Municipal Code Text Amendment (MCTA 26-02) – Adoption by Reference of the City of Sierra Madre Objective Design Standards by Adding Chapter 17.50 (Objective Design Standards) to and Amending Various Sections of Title 17 (Zoning) of the Sierra Madre Municipal Code Related to Multifamily Development Standards
CEQA: 14 CCR 15061(b)(3) - Common Sense Exemption
Recommended Action: Approve

7. CONSENT CALENDAR

All matters listed under the Consent Calendar are considered to be routine and can be acted on by one roll call vote. There will be no separate discussion of these items unless a member of the Planning Commission requests that a specific item be removed from the Consent Calendar for separate discussion and action.

- A. Regular Meeting Minutes of April 16, 2026
CEQA: Not a Project
Recommended Action: Approve

8. REPORTS FROM PLANNING COMMISSION

9. REPORTS FROM CITY STAFF

10. ADJOURNMENT

The Planning Commission will adjourn to its next regular meeting on N/A.

INFORMATION TO THE PUBLIC

The Planning Commission will consider the last item at 10:30 p.m. and they will adjourn the meeting by 11:00 p.m. The Planning Commission will continue all unfinished business to an adjourned meeting on the following Thursday at 5:30 p.m. or to a different time and date certain.

Copies of the Agenda are available for your convenience at the rear of the Council Chambers. State legislation (Govt. Code Section 54954.2) limits the Planning Commission's ability to take action on specific requests. Govt. Code Section 54954.2 limits the placement of items on the Agenda for action 72 hours prior to meetings, except for specific findings.

No action or discussion may be undertaken by the Planning Commission on any item if not posted on the agenda, except that Commissioners or staff may briefly respond to statements made or questions posed by the public, a Commissioner or staff may ask a question for clarification, make a brief announcement, or make a brief report on his or her own activities. A Commissioner or the Planning Commission itself may provide a reference to staff to report back to the Planning Commission at a subsequent meeting concerning any matter or may direct staff to place a matter of business on a future agenda.

REQUIRED FINDINGS

Conditional Use Permit and Variance considerations are "quasi-judicial" decisions made by the Planning Commission. As such, these decisions may be challenged in court. Accordingly, courts require an adequate "record" to exercise judicial review. This means that the documentation supporting the approval or denial of a project must include an explanation of how the Planning Commission processed the raw information and evidence considered in reaching its decision. The California Supreme Court has laid down distinct, definitive principles of law detailing the need for findings when a public agency approves or denies a project while acting in a "quasi-judicial" roll. This decision is based upon the case, *Topanga Assoc. for a Scenic Community v. County of Los Angeles* ("Topanga"). The "Topanga" court outlined the following 5 purposes for making findings:

- Provide a framework for making principled decisions, enhancing the integrity of the administrative process;
- Facilitate orderly analysis and reduce the likelihood the agency will randomly leap from evidence to conclusions;
- Serve a public relations function by helping to persuade the parties that the administrative decision making is careful, reasoned, and equitable;
- Enable the parties to determine whether and on what basis they should seek judicial review and remedies; and
- Apprise the reviewing court of the basis for the agency's decision.

For more information on the necessary "Findings" that the Planning Commission must make, please contact the Planning and Community Preservation Department at (626) 355-7138.

(Source: Curtin's California Land Use & Planning Law, Daniel)



CITY OF SIERRA MADRE

STAFF REPORT

PLANNING & COMMUNITY PRESERVATION

DATE: May 7, 2026
TO: Honorable Chair and the Planning Commission
FROM: Clare Lin, Planning Director
By: Katelyn Huang, Assistant Planner

SUBJECT: **Municipal Code Text Amendment (MCTA 26-02) – Adoption by Reference of the City of Sierra Madre Objective Design Standards by Adding Chapter 17.50 (Objective Design Standards) to and Amending Various Sections of Title 17 (Zoning) of the Sierra Madre Municipal Code Related to Multifamily Development Standards**

RECOMMENDATION

It is recommended that the Planning Commission hold a public hearing to consider Municipal Code Text Amendment No. 26-02, receive and consider all public testimony, and adopt Planning Commission Resolution No. 26-06, included as [Attachment 1](#), recommending that the City Council approve Municipal Code Text Amendment No. 26-02, consisting of an ordinance adding Chapter 17.50 (Objective Design Standards) and amending various sections of Title 17 (Zoning) of the Sierra Madre Municipal Code.

SUMMARY

The City of Sierra Madre is considering adoption of Objective Design Standards (ODS) prepared in coordination with the San Gabriel Valley Council of Governments (SGVCOG), The Arroyo Group, and Onyx Architects as part of a regional effort to develop State-compliant design standards tailored to local conditions. The proposed ODS would be adopted as a standalone document and incorporated into Title 17 (Zoning) of the Sierra Madre Municipal Code through the addition of Chapter 17.50 and related existing code amendments. The standards provide clear, measurable design requirements for qualifying multifamily and mixed-use projects in a manner consistent with recent State housing laws, while maintaining neighborhood compatibility, pedestrian-oriented site design, and overall design quality in Sierra Madre.

BACKGROUND

The City of Sierra Madre has participated in the development of a Regional ODS document led by the SGVCOG, as one of four partner cities—including Duarte, Alhambra, and La Puente—actively involved in drafting standards tailored to local context, with anticipated adoption in 2026. This effort is funded through the Southern California Association of Governments (SCAG) Regional Early Action Program (REAP) 2.0 Subregional Partnership (SRP), which is designed to accelerate housing production, support jurisdictions in meeting their sixth cycle Regional Housing Needs Assessment (RHNA) obligations, and advance state and regional priorities related to housing, transportation, equity, and climate. The City would also like to acknowledge the Arroyo Group and Onyx Architects for their leadership and dedicated work in guiding the development of the Regional ODS.

The Regional ODS are intended to provide a consistent, objective framework for design review that complies with recent State legislation, including Senate Bill (SB) 330 and SB 423, enabling jurisdictions to maintain local design oversight while facilitating streamlined housing approvals. Other State housing laws that form part of the legal basis for the ODS include SB 167, AB 2011, SB 4, SB 684, and SB 1123. Together, these statutes increasingly require or incentivize reliance on clear, measurable, and objective standards when reviewing qualifying housing projects.

Since June 2025, City staff and other local agencies have met with SGVCOG, the Arroyo Group, and Onyx Architects to discuss the baseline structure of the ODS documents, including the outline and research methodology for the standards. These meetings focused on aligning the Regional ODS with each participating jurisdiction's existing built form, regulatory framework, and housing needs.

In March 2026, SGVCOG hosted a stakeholder outreach meeting and invited local developers to provide feedback on residential and mixed-use design in the City as part of the ODS drafting process. An online comment form was also posted to collect input from residents and stakeholders throughout the San Gabriel Valley, ensuring that the resulting standards respond to both professional and community perspectives.

DISCUSSION & ANALYSIS

The proposed City of Sierra Madre Objective Design Standards are intended to provide clear, measurable design requirements for multifamily and mixed-use development in a manner consistent with State housing law, while preserving design quality and neighborhood compatibility in Sierra Madre. As described in the draft ODS, adoption of objective standards allows the City to continue applying design requirements to qualifying housing projects through standards that are uniformly verifiable, rather than through purely discretionary or subjective review. This approach is intended to provide greater certainty and predictability in the review process while maintaining the City's ability to achieve high-quality design outcomes.

This local context is especially important in Sierra Madre because the City's built form differs from many other San Gabriel Valley jurisdictions. The ODS document describes Sierra Madre as a small, village-like community at the base of the San Gabriel Mountains, with predominantly single-family neighborhoods and multifamily development concentrated near the city center and along corridors such as Sierra Madre Boulevard, Mariposa Avenue, Esperanza Avenue, Highland Avenue, and Suffolk Avenue. Most of the City's multifamily building stock consists of one- and two-story development, while mixed-use development remains limited. Because Sierra Madre is largely built out, future housing opportunities are expected to occur primarily through infill development rather than outward expansion. For that reason, the ODS are designed not only to satisfy State legal requirements, but also to guide how new multifamily and mixed-use projects fit into existing neighborhoods, reinforce pedestrian-oriented development, and maintain the City's modest scale and character. The introduction to the document identifies key design goals that include linking the private realm to the public realm, facilitating pedestrian activity and safety, activating streets and open spaces, promoting cohesive visual identity, prioritizing human-scaled design, and protecting residential privacy.

Due to the varying multifamily structure forms in the City, the ODS groups multifamily buildings into two categories: “House Scale” and “Block Scale” buildings and zones. House scale buildings contribute to a smaller-scale, neighborhood-oriented environment and typically include building types such as duplexes, bungalow courts, courtyard apartments, and townhouses. In Sierra Madre, the ODS identify the Medium/High and High Density Residential (R-3-13, R-3-20, and R-3-30), and Manufacturing zones as House Scale zones, while the Commercial (C) Zone is identified as the City’s Block Scale zone. Within this framework, the ODS use the house-scale and block-scale categories to tie standards to Sierra Madre’s actual zoning pattern and built context, ensuring that similar building types are regulated in a consistent, context-sensitive way.

The ODS are designed to apply to projects which qualify for State laws that may encourage or require the application of objective design standards in project review. These projects include:

- All new residential developments with two or more housing units.
- The residential and commercial components of new mixed-use developments with two or more housing units, where at least two-thirds of total floor area is residential (or 50 percent for qualifying large projects under AB 1893).
- Multifamily accessory dwelling units (ADUs), provided standards are not more stringent than State ADU law or effectively preclude ADU/JADU development.
- Remodeled buildings where new floor area is added, in which case only the modified structures and facades are subject to the standards.

In addition to defining where they apply, the ODS specify how qualifying projects will be reviewed and what topics the standards cover.

Key Content of the Standards

The ODS establish how the standards will function within the City’s broader project review framework. The document outlines three potential design review processes following adoption of the ODS:

1. Planning Commission Design Review: Allows for public input and increases transparency through public hearings, and allows for limited Planning Commission discretion within the bounds of State law. This process applies to applicable developments in the Medium/High Density Residential (R-3-13) Zone and Commercial (C) Zone, and to projects in the Manufacturing (M) Zone where Planning Commission review is required under the Zoning Code.
2. Modified Staff-Level Design Review: Provides a faster review period with a single Preliminary Design Review hearing before the Planning Commission, followed by a staff-level decision. This process applies to multifamily and mixed-use projects in the High Density Residential (R-3-20 and R-3-30) Zones and the Religious Housing Overlay (RHO) Zone.
3. Streamlined Ministerial Review: Applies to qualifying projects processed under State streamlining laws, including SB 4, SB 423, and AB 2011. For these projects, the City applies the ODS through a ministerial review consistent with the timelines and limitations established by State law.

In addition, the ODS document is organized into nine principal sections addressing the site and building design topics most relevant to project review:

Section 1, Site Planning and Access;
Section 2, Building Modulation and Articulation;
Section 3, Materials, Finishes, and Color;
Section 4, Frontages;
Section 5, Open Space;
Section 6, Entries;
Section 7, Exterior Lighting;
Section 8, Walls and Fences; and
Section 9, Loading Areas, Trash and Utilities.

Together, these sections establish objective standards governing how buildings relate to the street, how façade massing is broken down, how materials and frontage types are applied, how pedestrian access and open space are designed, and how service elements such as trash, loading, and utilities are screened and integrated into the project.

The ODS also include several appendices that provide additional detail to support consistent application of the standards. Appendix A establishes frontage standards and defines specific frontage types, with dimensional and design requirements for how buildings address the street. Appendices B and C describe common and private open space types, including minimum sizes and basic design characteristics for plazas, courtyards, balconies, and similar spaces. Appendix D provides definitions of technical and architectural terms used throughout the ODS to reduce ambiguity and support consistent interpretation. Appendix E incorporates the Regional ODS research memorandum, documenting the legal background, best practices, and regional analysis that informed preparation of the Sierra Madre ODS.

Relationship to Existing Regulations

The ODS are formatted as a standalone document that would be adopted by reference into Title 17 (Zoning) of the Sierra Madre Municipal Code. As proposed, the ordinance would add Chapter 17.50 (Objective Design Standards) and amend various sections of Title 17 related to multifamily development so that the ODS can be applied consistently across applicable residential, mixed-use, overlay, and other zoning districts. Specifically, Chapter 17.24 (Two-Family Residential Zone), Chapter 17.28 (Medium/High Density Residential Zone), Chapter 17.29 (High Density Residential Zones), Chapter 17.32 (Residential Entrepreneur Overlay Zone), Chapter 17.36 (Commercial Zone), Chapter 17.39 (Religious Housing Overlay Zone), Chapter 17.40 (Manufacturing Zone), and Chapter 17.59 (Ministerial Design Review Permits) would be amended to reference and integrate the ODS.

GENERAL PLAN CONSISTENCY

MCTA 26-02 is consistent with the following Goals and Policies of Sierra Madre General Plan's Housing Element in that it promotes a diverse range of housing types, reduced governmental constraints, and flexible mixed-use and innovative housing models while preserving community character and the low-scale downtown environment. The amendment implements this direction by aligning local development standards with State housing law through the use of Objective Design Standards.

- Goal 2.0: Facilitate the provision of a range of housing types to meet community needs.
 - Policy 2.1: Encourage diversity in the type, size, price and tenure of residential development in Sierra Madre, while maintaining quality of life goals.
 - Policy 2.4: Provide opportunities for the integration of housing in commercial districts, while maintaining the downtown's low scale character and ground level retail spaces.
- Goal 3.0: Reduce governmental constraints on the maintenance, improvement and development of housing while maintaining community character.
 - Policy 3.3: Provide flexibility in development standards to accommodate new models and approaches to providing housing, such as co-housing, shared housing, and live/work housing.

ENVIRONMENTAL ANALYSIS

This municipal code text amendment is exempt from the California Environmental Quality Act (CEQA) pursuant to CEQA Guidelines section 15061(b)(3), the "common sense" exemption. The proposed amendment does not, in itself, authorize or approve the construction of any specific building or structure, but instead establishes design regulations that will apply to future development. Because the amendment is limited to setting design standards and will not result in a reasonably foreseeable physical change to the environment, it can be seen with certainty that there is no possibility that the project may have a significant effect on the environment, and it is therefore not subject to CEQA review.

Approved by:



Clare Lin
Planning and Community Preservation Director

Attachments

[Attachment A - Planning Commission Resolution 26-06](#)

[Exhibit 1 - MCTA 26-02](#)

[Exhibit 2 - Sierra Madre Objective Design Standards Draft 2026.04.28 Compressed.pdf](#)

PLANNING COMMISSION RESOLUTION 26-06

A RESOLUTION OF THE PLANNING COMMISSION OF THE CITY OF SIERRA MADRE RECOMMENDING THE CITY COUNCIL ADOPT AN ORDINANCE, ADDING CHAPTER 17.50 (OBJECTIVE DESIGN STANDARDS) TO TITLE 17 (ZONING) OF THE SIERRA MADRE MUNICIPAL CODE, AND AMENDING VARIOUS SECTIONS OF TITLE 17 (ZONING) OF THE SIERRA MADRE MUNICIPAL CODE TO REFERENCE AND INCORPORATE THE SIERRA MADRE OBJECTIVE DESIGN STANDARDS WHERE APPLICABLE TO MULTIFAMILY DEVELOPMENTS.

RECITALS

WHEREAS, the State of California adopted several housings laws, including Senate Bill (SB) 167, SB 423, SB 4, SB 330, and Assembly Bill 2011, which strongly incentivize cities and counties to streamline the review process for multifamily housing, including mixed-use residential developments, and require local agencies to limit their review of qualifying housing projects to objective standards;

WHEREAS, pursuant to SB 423, Objective Design Standards "involve no personal or subjective judgment by a public official and are uniformly verifiable by reference to an external and uniform benchmark or criterion available and knowable by both the applicant or developer and the public official before submittal";

WHEREAS, the City participated as one of four partner cities in the development of a Regional Objective Standards document led by the San Gabriel Valley Council of Governments (SGVCOG);

WHEREAS, the SGVCOG effort was funded through Southern California Association of Governments (SCAG) Regional Early Action Program (REAP) 2.0 Subregional Partnership (SRP), which is designed to accelerate housing production, support jurisdictions in meeting their sixth cycle Regional Housing Needs Assessment (RHNA) obligations, and advance state and regional priorities related to housing, transportation, equity, and climate;

WHEREAS, the purpose of adopting Objective Design Standards is to comply with recent State legislation and to implement streamlined and ministerial review processes for qualifying projects by establishing reasonable, uniform, and comprehensive standards and procedures for multi-family residential and mixed-use development projects;

WHEREAS, the Objective Design Standards will apply to all new qualifying residential and mixed-use development projects, specifically where State law limits the City's enforcement of design standards to objective standards only, or where the Sierra Madre Municipal Code requires a ministerial approval process; and

WHEREAS, the Planning Commission held a duly noticed public hearing on May

7, 2026, to consider a Municipal Code Text Amendment (MCTA 26-02) and a recommendation for the City Council to adopt an ordinance.

THEREFORE, THE PLANNING COMMISSION OF THE CITY OF SIERRA MADRE, CALIFORNIA, DOES RESOLVE AS FOLLOWS:

SECTION 1. Recitals. The Recitals above are true and correct and incorporated herein by this reference.

SECTION 2. Municipal Code Text Amendment. The Planning Commission recommends that the City Council adopt an ordinance adding Chapter 17.50 (Objective Design Standards) and amending Chapter 17.24 (R-2 Two-Family Residential Zone), Chapter 17.28 (R-3-13 Medium/High Density Residential Zone), Chapter 17.29 (R-3-20 and R-3-30 High Density Residential Zones), Chapter 17.32 (R-E Residential Entrepreneur Overlay Zone), Chapter 17.36 (Commercial Zone), Chapter 17.39 (RHO Religious Housing Overlay Zone), Chapter 17.40 (Manufacturing Zone), and Chapter 17.59 (Ministerial Design Review Permits) of Title 17 (Zoning) of the Sierra Madre Municipal Code consistent with Municipal Code Text Amendment 26-02 included herein as Exhibit 1.

SECTION 3. Adoption of the City of Sierra Madre Objective Design Standards. The Planning Commission recommends that the City Council adopt by reference the City of Sierra Madre Objective Design Standards included herein as Exhibit 2.

SECTION 4. Consistency with the General Plan. Municipal Code Text Amendment 26-02 is consistent with the following Goals and Policies of Sierra Madre General Plan's Housing Element:

Goal 2.0: Facilitate the provision of a range of housing types to meet community needs.

Policy 2.1: Encourage diversity in the type, size, price and tenure of residential development in Sierra Madre, while maintaining quality of life goals.

Policy 2.4: Provide opportunities for the integration of housing in commercial districts, while maintaining the downtown's low scale character and ground level retail spaces.

Goal 3.0: Reduce governmental constraints on the maintenance, improvement and development of housing while maintaining community character.

Policy 3.3: Provide flexibility in development standards to accommodate new models and approaches to providing housing, such as co-housing, shared housing, and live/work housing.

The Housing Element promotes a diverse range of housing types, reduced governmental constraints, and flexible mixed-use and innovative housing models while preserving community character and the low-scale downtown environment. The amendment implements this direction by aligning local development standards with State housing law through the use of Objective Design Standards.

SECTION 5. California Environmental Quality Act. Municipal Code Text Amendment 26-02 is exempt from the California Environmental Quality Act (CEQA) pursuant to CEQA Guidelines Section 15061(b)(3), the "common sense" exemption. The proposed amendment does not authorize or approve the construction of any specific building or structure but instead establishes design regulations that will apply to future development. Because the amendment is limited to setting design standards and will not result in a reasonably foreseeable physical change to the environment, it can be seen with certainty that there is no possibility that the project may have a significant effect on the environment, and it is therefore not subject to CEQA review.

SECTION 6. Severability. If any sections, subsections, subdivisions, paragraph, sentence, clause or phrase of this Resolution or any part hereof or exhibit hereto is for any reason held to be invalid, such invalidity shall not affect the validity of the remaining portions of this Resolution or any part thereof or exhibit thereto. The City Council hereby declares that it would have passed each section, subsection, subdivision, paragraph, sentence, clause or phrase hereof, irrespective of the fact that anyone or more sections, subsections, subdivisions, paragraph, sentences, clauses or phrases be declared invalid.

SECTION 7. Certification. The Director of Planning and Community Preservation shall attest to the passage and adoption of this Resolution by the Planning Commission and shall cause the same to be listed in the records of the City.

SECTION 8. Effective Date. This Resolution shall take effect immediately upon adoption.

PASSED, APPROVED AND ADOPTED this 7th day of May 2026, by the following vote:

AYES:
NOES:
ABSTAIN:
ABSENT:

Thomas Denison, Chairperson
Sierra Madre Planning Commission

ATTEST:

Clare Lin, Director
Planning & Community Preservation
Department

Approved as to form:

Aleks Giragosian, City Attorney

Chapter 17.50 OBJECTIVE DESIGN STANDARDS

17.50.010 Purpose and intent.

The purpose of this Chapter is to provide the public, building and design professionals, and decision-makers with objective design criteria for new multifamily residential and mixed-use (residential and commercial) developments in the City.

17.50.020 Applicability.

The City of Sierra Madre Objective Design Standards apply to all new construction projects, regardless of zoning, that meet the following criteria:

- A. Multifamily Residential Projects: A project consisting of multifamily residential uses with two or more dwelling units, including detached and attached condominiums and accessory dwelling units created with existing or proposed multifamily development.
- B. Mixed-Use Projects: A project featuring a combination of residential and commercial uses where at least two-thirds of the square footage of the development is designated for residential uses.

17.50.030 Incorporation of the City of Sierra Madre Objective Design Standards.

The City of Sierra Madre Objective Design Standards are incorporated by reference into this Chapter. The City of Sierra Madre Objective Design Standards shall be treated as if contained within the City's Zoning Ordinance. A copy of the City of Sierra Madre Objective Design Standards is on file with the planning and community preservation department for use and examination by the public. To the extent that a development is other than multifamily residential or mixed-use (residential and commercial), the requirements of the underlying zone(s) shall prevail. Where there may be conflict, the City of Sierra Madre Objective Design Standards shall override.

17.50.040 Exceptions and exemptions.

All projects described in Section 17.50.020 are required to comply with the City of Sierra Madre Objective Design Standards. However, an applicant may request up to three (3) minor exceptions/exemptions if they are unable to meet certain City of Sierra Madre Objective Design Standards or may request to enter into an Alternative Standards Agreement to apply substitute standards in lieu of the City of Sierra Madre Objective Design Standards.

- A. This provision allows for limited discretionary review and flexibility for projects that may have a physical site constraint or propose an alternative architectural solution to a specific standard(s).
- B. Requests shall be made by the applicant in writing to the director as part of the entitlement application (conditional use permit, design review permit, or other application).
- C. The director has decision-making authority over exception/exemption and Alternative Standards Agreement requests. The decision of the director may be appealed to the Planning Commission in accordance with procedures established in Chapter 17.60.
- D. Exception/exemption or Alternative Design Standards Agreement request. The written justification for each exception/exemption or Alternative Standards Agreement request must identify the design standard(s) requested to be waived and how the request meets the applicable findings listed below.
 - 1. Exception/exemption findings. The director shall consider the request and information provided and make findings to approve or deny the request. An exception/exemption(s) shall be granted only if both of the following findings are made:
 - a. The project meets the intent of the design standard(s) under consideration to be waived, or a similar design standards is implemented in substitution.

- b. The project achieves the maximum number of residential dwelling units allowable, in accordance with the underlying zone, with the inclusion of the proposed exception/exemption(s).
- 2. Alternative Design Standards Agreement findings. The director shall consider the request for an Alternative Design Standards Agreement upon finding that:
 - a. The strict compliance with the City of Sierra Madre Objective Design Standards is not necessary to achieve the purpose and intent of this section;
 - b. The project achieves the maximum number of residential dwelling units allowable, in accordance with the underlying zone, with the application of the Alternative Standards Agreement;
 - c. The Alternative Design Standards Agreement is in a form approved by the director and city attorney, in each of their sole discretion; and
 - d. The project possesses compensating design and development features that offset impacts associated with the modification, waiver, or substitution of the City of Sierra Madre Objective Design Standards.
- 3. Density Bonus. Density Bonus Law allows for increased density and reductions in required development standards (i.e., concessions/incentives and waivers) for residential projects that meet certain affordability requirements. The exception/exemption and Alternative Design Standards Agreement processes set forth in this section are in conjunction with the concessions/incentives and waiver process permitted under Density Bonus Law (Government Code Section 65915) and/or other applicable state laws. If an applicant requests a concession/incentive and/or waiver under Density Bonus Law for any standard within the City of Sierra Madre Objective Design Standards, it would also be counted as one (1) allowed waivers for the purposes of exceptions/exemptions under this Section.

17.50.050 Amendments to the City of Sierra Madre Objective Design Standards.

- A. Minor amendments to the City of Sierra Madre Objective Design Standards shall not result in a significant change to any design standard. Minor amendments shall be reviewed by the director and any approved minor amendments to the City of Sierra Madre Objective Design Standards shall be issued in writing. Minor amendments include adjustment of a numeral requirement or addition of language to clarify existing standards for any of the following purposes:
 - 1. To comply with changes in state law; or
 - 2. To ensure consistency with policies, goals, and objectives of the City as declared by the City Council.
- B. Major amendments include modifications that result in the addition or removal of standards within the City of Sierra Madre Objective Design Standards. Any amendment that results in a significant change to a design standard shall also be considered a major amendment. Major amendments shall be reviewed by the planning commission at the recommendation of the director and any approved major amendment to the City of Sierra Madre Objective Design Standards shall be issued via resolution at a noticed public hearing.

Chapter 17.24 R-2 TWO-FAMILY RESIDENTIAL ZONE

17.24.030 Standards of development—Generally.

All premises in the R-2 zone shall comply with the standards of development set forth in the following sections. For multifamily residential development, the standards of this Chapter 17.24 shall be considered in combination with the City of Sierra Madre Objective Design Standards (Chapter 17.50). Where there may be conflict, the City of Sierra Madre Objective Design Standards shall override. To the extent that a development is other than multifamily residential, the requirements of this Chapter 17.24 shall prevail.

Chapter 17.28 R-3-13 MEDIUM/HIGH DENSITY RESIDENTIAL ZONE

17.28.080 Standards of development.

[For multifamily residential development, the standards of this Chapter 17.28 shall be considered in combination with the City of Sierra Madre Objective Design Standards \(Chapter 17.50\). Where there may be conflict, the City of Sierra Madre Objective Design Standards shall override. To the extent that a development is other than multifamily residential, the requirements of this Chapter 17.28 shall prevail.](#)

A. Floor Area Ratio:

1. On lots with a gross lot area of less than ten thousand square feet or street frontage of less than fifty feet, the floor area of all above-ground buildings and structures (including garages and other non-habitable areas, but excluding basements and other fully subterranean areas) shall be limited to fifty-five percent of the gross lot area.
2. On lots with a gross lot area of ten thousand square feet or greater and with a street frontage of fifty feet or greater, the floor area of all above-ground building and structures (including garages and other non-habitable areas, but excluding basements and other fully subterranean areas) shall be five thousand five hundred square feet plus seventy percent of gross lot area in excess of ten thousand square feet.
3. Notwithstanding paragraphs 1 and 2 above, on lots with (i) one dwelling unit, the floor area of all above-ground buildings and structures (including garages and other non-habitable areas, but excluding basements and other fully subterranean areas) shall be limited to thirty-five percent of the gross lot area, (ii) one dwelling unit and one second unit, the floor area of all above-ground buildings and structures (including garages and other non-habitable areas, but excluding basements and other fully subterranean areas) shall be limited to forty percent of the gross lot area, and (iii) two dwelling units, the floor area of all above-ground buildings and structures (including garages and other non-habitable areas, but excluding basements and other fully subterranean areas) shall be limited to forty-five percent of the gross lot area.

B. Maximum Building Coverage.

1. Building coverage shall not exceed an aggregate of forty-five percent of the lot area. Covered area shall be considered to be the total amount of land covered by residential structures, garages, driveways, and other impermeable surfaces.
2. Decks, permeable patios, porous paving areas, vegetated roof areas, recreational areas, pedestrian walkways and terraces shall not be considered covered areas for the purpose of this standard. An additional fifteen percent in covered area may be added to the aggregate, increasing it to sixty percent with the use of porous surfaces and/or vegetated roof areas.

C. Maximum Building Height. No building shall exceed either thirty feet in height or two stories above grade (see illustration below).

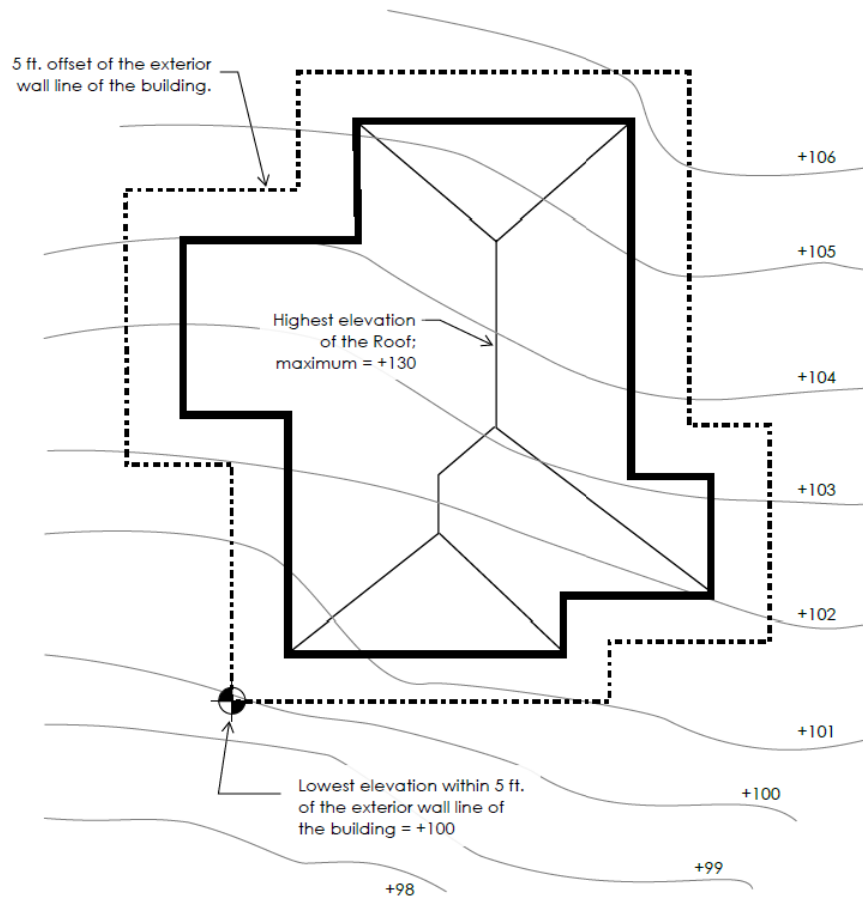

D. Yard and Building Setbacks:

Lot Line	Bounded By	Building Type	Required Setback (feet)
Front		First floor Second floor	15 feet 25 feet
Rear			10 feet
Side or Rear	R-1 zoned lots	Structures over one-story in height	10 feet for height below 20 feet, plus use of "angle-plane" in accordance with subsection F.7 below
Side	An alley or lots zoned other than R-1	Main or accessory	10% of lot width 5 minimum 15 maximum
Side	Public street	Main or accessory	10% of lot width 10 minimum 15 maximum
Side	An alley	Garages opening to alley	25 from opposite side of alley

E. Encroachments into setback areas:

1. Garages and other one-story accessory structures may be constructed within three feet of a side or rear property line where the difference between adjoining grades does not exceed one foot and is not adjoining an R-1 zoned property.
2. Walls and fences in accordance with Section 17.48.130.
3. Balconies and Exterior Stairways. No more than one-half of the balconies and exterior stairways shall be permitted to project more than fifty percent of the minimum setback requirement into any required setback areas. The minimum setback from any property line abutting R-1 zoned property shall be ten feet.
4. Swimming pools, hot tubs, spas and similar recreational facilities may be located no closer than five feet from the rear or side property lines, or twenty-five feet from the front property line.
5. Other projections as allowed in accordance with Section 17.48.120.

F. Site Design Requirements.

1. Siting: Building siting should:
 - a. Maximize privacy through placement of windows, balconies, landscaping, and design of outdoor spaces;
 - b. Be related to nearby buildings as well as adjacent parcels;
 - c. Be oriented to face the street, avoiding views from the street of parking garages and alleys;
 - d. Minimize negative impact on views from adjacent properties;
 - e. Be oriented to encourage use of outdoor areas and to be compatible with adjoining building orientation; and
 - f. Cluster buildings and modulate architectural elements to provide pleasing and useful ground level and above ground spaces.
2. Utilities: All utilities shall be placed underground.
3. Landscaping: Landscaping should be designed to minimize impact of development on surrounding properties. Tree preservation and landscaping with specimen trees are encouraged.
4. Contextual design: Building forms and details should be in keeping with adjacent neighborhood character, where appropriate. Where possible, existing single-family houses should be preserved.
5. Building materials: Materials, colors and textures generally should be compatible with those of adjacent and other nearby buildings and the overall character of the neighborhood.
6. Paving: Use of decorative and permeable materials is encouraged.
7. Angle-plane: For yards abutting an R-1 zoned lot, an encroachment limit shall be established which is determined at a point twenty feet above the existing ground level at the setback line as required by subsection D above, and using a forty-five-degree angle inwards toward the property to create additional setback (see illustration below).

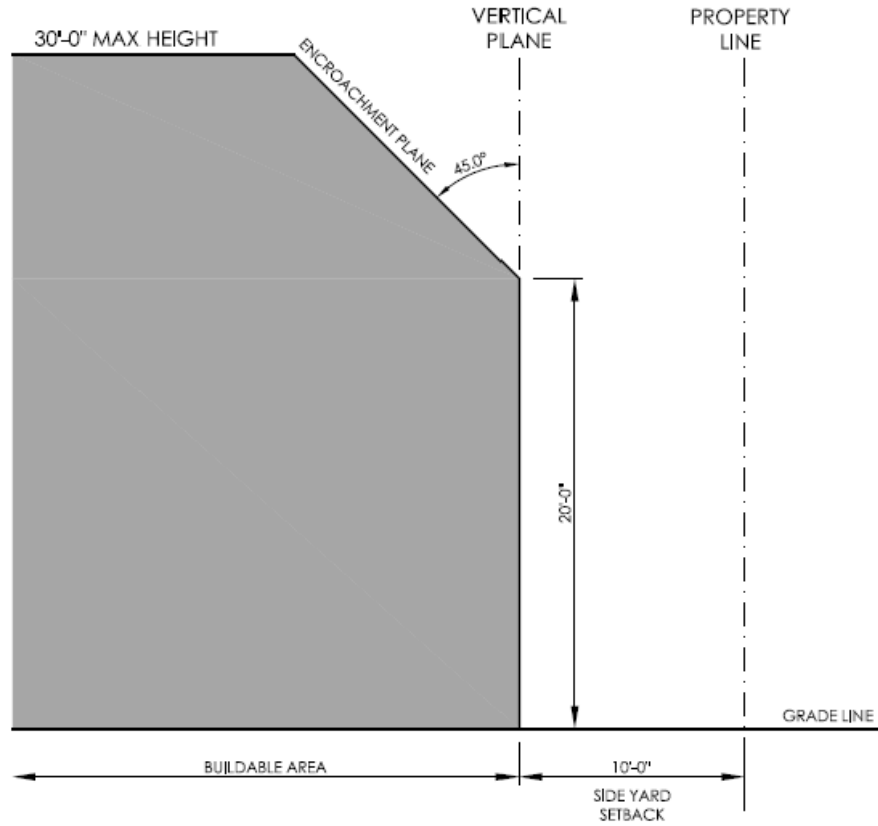

8. Articulation: Articulation of exterior walls is encouraged. In no event shall a linear wall of a second story extend longer than thirty-five feet without an offset of a minimum of five feet for a minimum linear distance of ten feet (see illustration below).

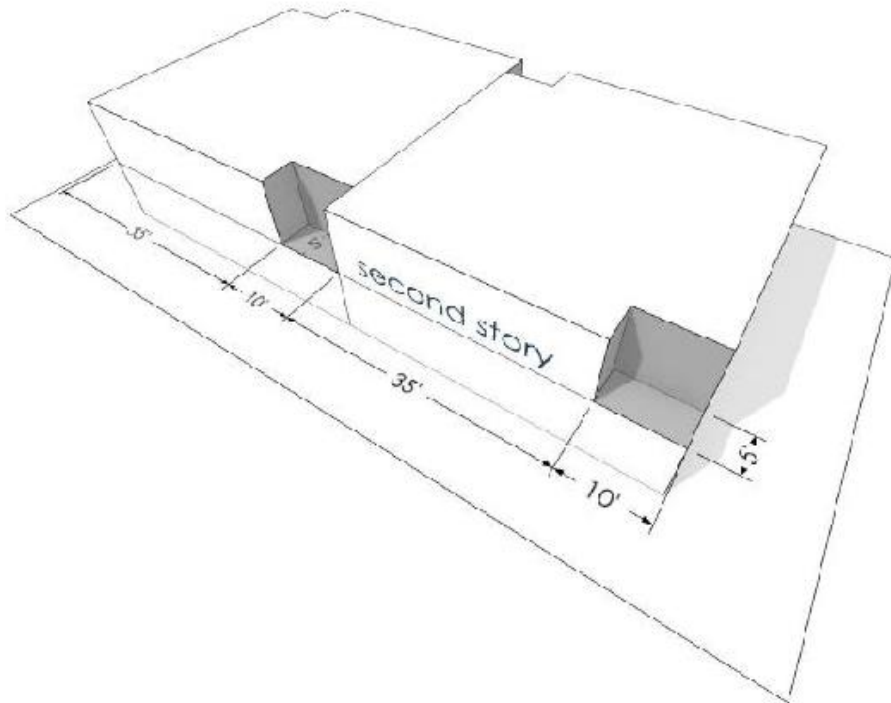

9. Screening: Parking areas, refuse storage, mechanical equipment and the like shall be screened by some combination of walls, plantings or earthworks.
10. Design guidelines: From time to time, the planning commission may promulgate and maintain site design and massing guidelines for use by applicants and the city to guide appropriate development in the R-3-13 zone.

Chapter 17.29 R-3-20 AND R-3-30 HIGH DENSITY RESIDENTIAL ZONES

17.29.030 Development regulations.

For multifamily residential development, the standards of this Chapter 17.29 shall be considered in combination with the City of Sierra Madre Objective Design Standards (Chapter 17.50). Where there may be conflict, the City of Sierra Madre Objective Design Standards shall override. To the extent that a development is other than multifamily residential, the requirements of this Chapter 17.29 shall prevail. When not in conflict with the City of Sierra Madre Objective Design Standards, ~~The~~ the regulations and limitations pertaining to the R-3-13 zone shall control and be effective in the R-3-20 and R-3-30 zones (Chapter 17.28 of this title) for multi-family dwellings, with the following exceptions:

- A. Minimum Lot Size. The minimum lot size for new development shall be eleven thousand square feet.
- B. Allowable Density. The allowable dwelling unit density of development shall be as follows:
 - a. R-3-20: Minimum twenty dwelling units/acre, up to twenty-four dwelling units/acre.
 - b. R-3-30: Minimum thirty dwelling units/acre, up to thirty-four dwelling units/acre.
- C. Multi-family projects are not subject to the requirements of Section 17.28.070.
- D. Yard and Building Setbacks. In the R-3-30 zone only, the minimum front yard setback for the first and second floors shall be fifteen feet.
- E. Height. A third story building element shall be permitted, provided that this element is located more than forty feet away from any public street and has no horizontal dimension longer than forty-five feet. Additionally, the total floor area of these elements shall equal no greater than twenty percent of the gross lot area. For any project containing a third story, the height limit shall be measured in compliance with the calculation method described in Section 17.20.040 for the R-1 zone, except that the maximum height shall be thirty feet instead of twenty-five feet.
- F. Articulation. The standards described in Section 17.28.080.F.8 shall apply to all stories above the first story.
- G. Floor Area Ratio. The floor area ratio of developments containing more than eleven dwelling units shall be limited to one hundred percent of the gross lot area, except that pursuant to Government Code 65913.11, the floor area of developments containing eight to ten units shall be limited to one hundred twenty-five percent of the gross lot area.
- H. Maximum building coverage requirements shall not apply.
- I. Open space. Two hundred fifty square feet per dwelling unit of on-site open space shall be provided on the ground level for use by residents. Open spaces may be common or private. In order to be counted toward the open space requirement, the minimum width and length of each space shall be ten feet. Driveways and other vehicular access areas shall not count toward the open space requirement.

Chapter 17.32 R-E RESIDENTIAL ENTREPRENEUR OVERLAY ZONE

17.32.020 Standards of development.

For multifamily residential or mixed-use (residential and commercial) development, the standards of the underlying zone shall be considered in combination with the City of Sierra Madre Objective Design Standards (Chapter 17.50). Where there may be conflict, the City of Sierra Madre Objective Design Standards shall override. To the extent that a development is other than multifamily residential or mixed-use (residential and commercial), the requirements of the underlying zone shall prevail.

Chapter 17.36 C COMMERCIAL ZONE

17.36.050 Standards of development—Generally.

The development standards set forth in the following sections of this chapter shall apply to all construction within the C zone. For multifamily residential or mixed-use (residential and commercial) development, the standards of this Chapter 17.36 shall be considered in combination with the City of Sierra Madre Objective Design Standards (Chapter 17.50). Where there may be conflict, the City of Sierra Madre Objective Design Standards shall override. To the extent that a development is other than multifamily residential or mixed-use (residential and commercial), the requirements of this Chapter 17.36 shall prevail.

Chapter 17.39 RHO RELIGIOUS HOUSING OVERLAY ZONE

17.39.060 Development standards.

For multifamily residential development, the standards of this Chapter 17.39 shall be considered in combination with the City of Sierra Madre Objective Design Standards (Chapter 17.50). Where there may be conflict, the City of Sierra Madre Objective Design Standards shall override. To the extent that a development is other than multifamily residential, the requirements of this Chapter 17.39 shall prevail.

- A. Off-street Parking.
 - a. Reutilization of Church Parking. Reductions in parking for church and school uses below the minimum otherwise required by this Municipal Code is permitted to construct development that conforms to the standards of this chapter. The reduction in parking allowed shall be limited to the footprint of the residential structures and accessory structures, open space or landscaping serving the residential development.
 - b. Residential Parking Standards. Development under the RHO zone is eligible for the alternative or special parking standards described in Section 17.34.070.
 - c. Off-Site Parking. Parking for any on-site use may be located on the same lot as the use the parking will serve. When a parking lot is located on a site other than that on which the facility being served is located, an agreement approved by the city attorney reserving the site for parking purposes shall be recorded in the office of the Los Angeles County recorder. Such off-site parking shall be located no more than six hundred feet walking distance from the nearest point of the building that the parking is required to serve.
- B. Height.
 - a. Height Limit. No building shall exceed either thirty-five feet in height or three stories above grade, as calculated in the manner illustrated in Section 17.28.080.C.

- b. Height Adjacent to Public Streets. No building shall exceed either thirty feet in height or two stories above grade within forty feet from any public street other than Michillinda Avenue.
- c. Height Adjacent to R-1 Zone. For yards abutting an R-1 zoned lot, an encroachment limit shall be established which is determined at the point where the wall height is twenty feet, and using a forty-five-degree angle inwards toward the property to create additional setback. (See illustration in Section 17.28.080.F.7).
- C. Front Setback. The minimum front setback shall be fifteen feet for all floors of the building, except along Michillinda Avenue and Baldwin Avenue, where the minimum front setback shall be five feet.
- D. Open Space. One hundred seventy-five square feet per dwelling unit of on-site open space shall be provided for use by residents. Such open space may be located on the ground floor or above, and may be met with a combination of common open space and private open space. In order to be counted toward the open space requirement, the minimum width and length of each space shall be ten feet for common spaces and five feet for private spaces. Driveways and other vehicular access areas shall not count toward the open space requirement.
- E. Podium Parking Requirements. Any parking constructed at or above grade shall not be oriented along the frontage of any street. Parking constructed partially above grade shall be permitted along the frontage of a street only along Michillinda Avenue.
- F. All other development standards shall conform to the requirements of Section 17.28.080, with the exception of lot coverage and floor area ratio standards, which shall not apply.

Chapter 17.40 M MANUFACTURING ZONE

17.40.020 Property development standards.

Notwithstanding anything to the contrary in this chapter, projects incorporating uses permitted in the C zone, including residential uses, shall be developed in locations, to development standards, and with required reviews and approvals only as set forth in Chapter 17.36. [For multifamily residential or mixed-use \(residential and commercial\) development, the standards of this Chapter 17.40 shall be considered in combination with the City of Sierra Madre Objective Design Standards \(Chapter 17.50\). Where there may be conflict, the City of Sierra Madre Objective Design Standards shall override. To the extent that a development is other than multifamily residential or mixed-use \(residential and commercial\), the](#) ~~The~~ regulations set forth in the following sections shall apply ~~to all other uses and development~~ in the M zone.

Chapter 17.58 SMALL HOME LOT DEVELOPMENTS

17.58.050 Development standards.

[For multifamily residential development, the standards of this Chapter 17.58 shall be considered in combination with the City of Sierra Madre Objective Design Standards \(Chapter 17.50\). Where there may be conflict, the City of Sierra Madre Objective Design Standards shall override. To the extent that a development is other than multifamily residential, the requirements of this Chapter 17.58 shall prevail.](#)

- A. Design and Development Standards. This section incorporates the design and development standards in this code unique to each zone, except as modified by this section.
- B. Angle Plane. The angle plane standards in this chapter shall be governed by the angle plane standards in the underlying zone.
- C. Building and Design Standards.

1. All the dwelling units shall have consistent exterior wall materials, identified color tones, window types, door and window trims, roofing materials and roof pitch.
 2. Roof decks are prohibited.
 3. All dwelling units ministerially approved under this chapter will install a new or separate utility connection.
 4. All electrical and utility services to a new dwelling unit shall be undergrounded.
 5. If an adjoining property installed a solar energy system, the applicant shall submit a shadow study prepared by an engineer licensed by the Board of Professional Engineers, Land Surveyors, and Geologists or by an architect licensed by the California Architects Board. The shadow of any proposed development shall not cover more than ten percent of the area of any solar energy system on any adjoining property.
- D. Density Standards. The development must result in at least as many units as the maximum allowable residential density allowed under the zoning ordinance.
- E. Fire Safety Standards.
1. All new dwelling units are required to comply with Chapter 15.24 of this code.
 2. Where two dwelling units are configured as sharing a common wall, a one-hour fire wall between the units is required.
 3. All new dwelling units are required to comply with Chapter 15.24 (Fire Code) and have fire sprinklers.
 4. All new dwelling units are required to use fire-resistant building materials.
 5. All new dwelling units are required to comply with Chapter 8.36 (Hazardous Brush Clearance) and maintain defensible space around these units.
 6. New or modified detached dwelling units shall be separated from any other dwelling unit or building by ten feet to prevent the spread of fire.
- F. Floor Area Standards.
1. The average total floor area shall not exceed one thousand seven hundred fifty square feet.
 2. The total floor area standards in this chapter shall be governed by the floor area standards in the underlying zone.
- G. Height Standards. The maximum height standards in this chapter shall be governed by the height standards in the underlying zone.
- H. Lot Coverage Standards. The lot coverage standards in this chapter shall be governed by the lot coverage standards in the underlying zone.
- I. Lot Size Standards. The maximum lot size may not exceed five acres.
- J. Open Space Standards. Two hundred fifty feet per dwelling unit of on-site open space shall be provided on the ground level for use by residents. Open space may be common or private. To be counted toward the open space requirement, the minimum width and length of each space shall be ten feet. Driveways and other vehicular access areas shall not count toward the open space requirement.
- K. Parking Standards. The parking standards in this chapter shall be governed by the parking standards in the underlying zone, except that the required parking need not be enclosed or covered.
- L. Setback Standards.
1. The front, side, and rear setbacks from the lot line will be determined by the zoning district in which the dwelling unit is located.

2. No setback is required between units, except as required by Title 15 of this code.
3. All portions of the dwelling unit, including eaves, awnings, sills, cornices, chimneys, overhangs and other projections, may encroach into front, side or rear yards or setbacks in a manner consistent with the building design but in no case greater than one foot in depth.

Chapter 17.59 MINISTERIAL DESIGN REVIEW PERMITS

17.59.050 Development standards.

[For multifamily residential development, the standards of this Chapter 17.59 shall be considered in combination with the City of Sierra Madre Objective Design Standards \(Chapter 17.50\). Where there may be conflict, the City of Sierra Madre Objective Design Standards shall override. To the extent that a development is other than multifamily residential, the requirements of this Chapter 17.59 shall prevail.](#)

- A. Design and Development Standards. This section incorporates the design and development standards in this code unique to each zone, except as modified by this section.
- B. Angle Plane. The angle plane standards in this chapter shall be governed by the angle plane standards in the underlying zone.
- C. Building and Design Standards.
 1. For a detached unit, the exterior materials and design shall match the design of any existing primary dwelling unit on the property through the use of the same exterior wall materials, identified color tones, window types, door and window trims, roofing materials and roof pitch.
 2. For an attached unit, the exterior materials, windows and other architectural features shall match the existing structure by employing the same building form, color tones, window design, door and window trims, roofing materials and roof pitch.
 3. Roof decks are prohibited.
 4. All dwelling units ministerially approved under this chapter will install a new or separate utility connection.
 5. All electrical and utility services to a new dwelling unit shall be undergrounded.
 6. If an adjoining property installed a solar energy system, the applicant shall submit a shadow study prepared by an engineer licensed by the board of professional engineers, land surveyors, and geologists or by an architect licensed by the California Architects Board. The shadow of any proposed development shall not cover more than ten percent of the area of any solar energy system on any adjoining property.
- D. Density Standards. No development may include more than two residential housing units under this chapter and no more than four residential housing units under this code.
- E. Fire Safety Standards.
 1. All new dwelling units are required to comply with Chapter 15.24 of this code.
 2. Where two dwelling units are configured as sharing a common wall, a one-hour fire wall between the units is required.
 3. All new dwelling units are required to comply with Chapter 15.24 (Fire Code) and have fire sprinklers.
 4. All new dwelling units are required to use fire-resistant building materials.
 5. All new dwelling units are required to comply with Chapter 8.36 (Hazardous Brush Clearance) and maintain defensible space around these units.

6. New or modified detached dwelling units shall be separated from any other dwelling unit or building by ten feet to prevent the spread of fire.
- F. Floor Area Standards. The total floor area standards in this chapter shall be governed by total floor area standards in the underlying zone.
 - G. Height Standards. The maximum height standards in this chapter shall be governed by the height standards in the underlying zone. If there is an existing primary dwelling on the parcel, then the maximum height of the existing residence cannot be increased through use of this chapter.
 - H. Lot Coverage Standards. The lot coverage standards in this chapter shall be governed by the lot coverage standards in the underlying zone.
 - I. Lot Size Standards.
 1. The minimum lot size standards in this chapter shall be governed by the lot size standards in the underlying zone.
 - J. Open Space Standards. Two hundred fifty feet per dwelling unit of on-site open space shall be provided on the ground level for use by residents. Open space may be common or private. To be counted toward the open space requirement, the minimum width and length of each space shall be ten feet. Driveways and other vehicular access areas shall not count toward the open space requirement.
 - K. Parking Standards.
 1. One off-street, covered parking space is required for each new dwelling unit.
 2. The parking space shall be a dimension of at least ten feet wide, eight feet tall, and twenty feet deep.
 3. If a new dwelling unit is located within one-half mile walking distance of either a high-quality transit corridor, as defined in Public Resources Code Section 21155(b), or a major transit stop, as defined in Public Resources Code Section 21064.3, or if there is a car share vehicle located within one block of the parcel, then off-street parking required pursuant to this section shall not apply.
 - L. Setback Standards.
 1. The front setbacks from the lot line will be determined by the zoning district in which the dwelling unit is located;
 2. The minimum side and rear setbacks from the lot line will be four feet.
 3. No additional setback is required for a new dwelling unit constructed in the same location as an existing structure on the parcel.
 4. All portions of the dwelling unit, including eaves, awnings, sills, cornices, chimneys, overhangs and other projections, may encroach into front, side or rear yards or setbacks in a manner consistent with the building design but in no case greater than one foot in depth.

City of Sierra Madre Objective Design Standards



April 28, 2026



Table of Contents

TABLE OF CONTENTS

Introduction.....	3	Section 9: Loading Areas, Trash and Utilities.....	23
Section 1: Site Planning and Access.....	10	9.1: Commercial Loading Areas.....	23
1.1 - 1.5: Street Relationships.....	10	9.2: Screening Loading Areas.....	23
1.6 - 1.7: Residential Privacy.....	10	9.3 - 9.4: Trash Enclosures & Location.....	23
1.8 - 1.11: Pedestrian Access.....	11	9.5 - 9.6: Utility Location.....	23
1.12 - 1.13: Parking Areas.....	11	Appendix A: Frontage Standards.....	24
1.14 - 1.20: Vehicular Access.....	11	A.1: Shopfront.....	24
Section 2: Building Modulation and Articulation.....	12	A.2: Common Entry.....	25
2.1 - 2.4: Ground Floor Design.....	12	A.3: Stoop.....	26
2.5: Circulation Design.....	12	A.4: Porch.....	27
2.6: Architectural Projections.....	12	A.5: Patio.....	28
2.7: Transparency.....	12	A.6: Surface Parking.....	29
2.8 - 2.16: Variation in Wall Plane.....	13	A.7: Structured Parking.....	30
2.17 - 2.20: Roof Design.....	14	Appendix B: Common Open Space Types.....	31
2.21: Commercial Zone and Historic Resource-Adjacent Development.....	14	B.1: Community Plazas and Commons.....	31
Section 3: Materials, Finishes, and Color.....	15	B.2: Neighborhood Parks and Recreational Amenity Areas.....	32
3.1 - 3.6: Materials.....	15	B.3: Courtyards.....	32
3.7 - 3.8: Finishes.....	15, 16	B.4: Forecourts.....	33
3.9 - 3.11: Color.....	16	B.5: Pocket Parks.....	33
3.12 - 3.16: Character.....	16	B.6: Paseos.....	34
Section 4: Frontages.....	17	B.7: Passthroughs.....	34
Section 5: Open Space.....	18	B.8: Alley Walkways/Green Alleys.....	35
5.1 - 5.4: General Open Space.....	18	B.9: Shared Yards.....	35
5.5 - 5.11: Common Open Space.....	18	B.10: Terraces and Decks.....	36
5.12: Private Open Space.....	18	B.11: Rooftop Decks.....	36
Common Open Space Heirarchy.....	19	B.12: Green Roofs.....	37
Section 6: Entries.....	20	Appendix C: Private Open Space Types.....	38
6.1 - 6.3: Entry Locations.....	20	C.1: Balconies.....	38
6.4 - 6.7: Entry Design.....	20	C.2: Patios.....	38
6.8- 6.9: Security Features.....	20	C.3: Private Rooftop Decks.....	39
Section 7: Exterior Lighting.....	21	C.4: Private Yards.....	39
7.1 - 7.4: Lighting Along Walkways.....	21	C.5: Porches.....	40
7.5: Design of Lighting.....	21	Appendix D: Definitions.....	41
7.6: Landscape Lighting.....	21	Appendix E: SGVCOG Regional Objective Design Standards Research Memorandum.....	44
Section 8: Walls and Fences.....	22	External Image Sources.....	80
8.1: Screening.....	22		
8.2 - 8.4: Wall and Fence Height.....	22		
8.5 - 8.8: Design of Walls and Fences.....	22		
8.9: Location of Walls and Fences.....	22		

Introduction

BACKGROUND AND RATIONALE

These City of Sierra Madre Objective Design Standards were prepared by The Arroyo Group in cooperation with the City of Sierra Madre to provide clear, objective, and measurable standards for multifamily and mixed use development, satisfying the demands of state law. This Standards document **was** derived from the Regional Objective Design Standards document which was developed by The Arroyo Group **on behalf of the San Gabriel Valley Council of Governments (SGVCOG)**.

Several state housing laws, including SB 167, SB 423, SB 330, SB 4, and AB 2011, strongly incentivize cities to develop objective design standards for multifamily residential uses and mixed (residential + commercial) uses. A summary of each law is given on the next page. By adopting Objective Design Standards, the City of Sierra Madre maintains the ability to impose design standards on multifamily residential and mixed use developments.

Per SB 423, Objective Design Standards "involve no personal or subjective judgment by a public official and are uniformly verifiable by reference to an external and uniform benchmark or criterion available and knowable by both the applicant or developer and the public official before submittal." Providing this level of certainty and clarity introduces predictability in the review process. Together with other state requirements such as clear timelines for decisions to approve or deny a project and a limitation on the number of public meetings, *these Objective Design Standards are intended to streamline the approval process for housing units while maintaining good design.*

Examples of Well Designed Buildings:



Townhomes at 102 Esperanza, Sierra Madre. Successful relationship between the townhome unit and the public realm, in addition to well designed landscaping



The Kensington, Sierra Madre. Successfully designed mixed use building, ground floor commercial uses and upper floor residential units



Sierra Vista Apartments, Sierra Madre. Successful implementation of Craftsman architecture and well designed private open space balconies

Examples of Undesirable or Incompatible Design:



Lack of landscaping between the duplex and the street frontage.



Lack of relationship between units and frontage



Large portion of frontage dominated by surface parking and a driveway

Introduction

These standards have been crafted to encourage new, well designed residential and mixed use development that fits the context of the City of Sierra Madre (see the top row of images on page 3). They establish a "floor" for design quality, thereby preventing undesirable, incompatible design (see the bottom row of images on page 3).

Design Goals

Several key goals that guided the development of the standards were:

- Visually and functionally link the private realm to the public realm
- Facilitate pedestrian activity and safety
- Activate the public realm
- Encourage projects to exhibit a cohesive visual identity that is consistent with the character of the area
- Prioritize human-scaled design
- Safeguard residential privacy as well as proper screening and buffering

Standards Organization

Standards are organized by the following topics:

- Section 1: Site Planning and Access
- Section 2: Building Modulation and Articulation
- Section 3: Materials, Finishes, and Color
- Section 4: Frontages
- Section 5: Open Space
- Section 6: Entries
- Section 7: Exterior Lighting
- Section 8: Walls and Fences
- Section 9: Loading Areas, Trash and Utilities
- Appendix A: Frontage Standards
- Appendix B: Common Open Space Types
- Appendix C: Private Open Space Types
- Appendix D: Definitions

LEGAL BASIS FOR OBJECTIVE DESIGN STANDARDS

Per Government Code 65913.4, Objective Design Standards "involve no personal or subjective judgment by a public official and are uniformly verifiable by reference to an external and uniform benchmark or criterion available and knowable by both the applicant or developer and the public official before submittal." The following Senate bills (SB) and Assembly bills (AB) form the legal basis for objective design standards in California. Additional State bills signed into law in the future may interact with objective design standards.

SB 167 (2017) (codified in Section 65589.5 of the Government Code)

Prohibits local governments from disapproving or conditioning approval in a manner that renders infeasible, a housing development project for very low, low-, or moderate- income households or an emergency shelter unless the local agency makes specific written findings based upon substantial evidence in the record. Under this Senate Bill local jurisdictions may not reduce density or make infeasible housing projects consistent with objective design standards.

Housing Crisis Act (SB 330) (2019) (codified in Sections 65589.5, 65940, 65943, 65950, 65905.5, 65913.10, and 65941.1, and Chapter 12 of Division 1 of Title 7 of the Government Code)

Streamlines housing development processes by imposing timelines on the approval of housing projects, limits the number of public hearings to 5, and limits denial of projects to non-compliance with objectively written design standards.

AB 2011 (2022) (codified in Sections 65400, 65585, and Chapter 4.1 of Division 1 of Title 7 of the Government Code)

Allows eligible residential development projects in commercial areas that comply with housing affordability and/or labor standards to be subject to a streamlined, ministerial review process that is exempt from CEQA. As part of the ministerial process, design review may be undertaken by the City if only objective standards are evaluated.

SB 4 (2023) (codified in Section 65913.16 of the Government Code)

Requires 100% Affordable Housing Projects proposed on land owned by religious institutions (and that meet all other requirements of SB 4) comply with all objective development standards of the city or county they are located in that do not conflict with SB 4. As part of the ministerial process, design review may be undertaken by a City if only objective standards are evaluated.

SB 423 (2023) (codified in Section 65913.4 of the Government Code)

Requires cities to streamline review and approval of eligible affordable housing projects through a ministerial process. As part of the ministerial process, design review may be undertaken by the City if only objective standards are evaluated.

SB 684 (2023) and SB 1123 (2024) (SB 684 is codified in Sections 65852.28, 65913.4.5, and 66499.41 of the Government Code) (SB 1123 is codified in Sections 65852.28 and 66499.41 of the Government Code)

Requires local agencies to ministerially approve, without discretionary review or a public hearing, parcel map or tentative and final maps for housing development projects of ten or fewer residential units on urban lots of less than five acres. SB 684 further specifies that the proposed subdivision must be located on a parcel zoned for multifamily residential use, no larger than five acres, and substantially surrounded by qualified urban uses. Per these laws, Cities may impose objective design standards, except for those which physically preclude the development of a project built to specified densities. Additionally, objective design standards may not be imposed related to setback between units, enclosed or covered parking, side and rear setbacks different from the original lot line, certain parking requirements, and certain minimum FARs.

Legal Basis for Objective Design Standards in California State Law

Introduction

CITY OF SIERRA MADRE CONTEXT

The City of Sierra Madre, nestled at the foot of the San Gabriel Mountains, lies between the cities of Pasadena to the west and Arcadia to the east. The City currently is home to 11,000 citizens. The City of Sierra Madre was founded in 1881. In the late 1800s, the City was a small village, with a Post Office and City Hall, surrounded by orange orchards. In 1907, Sierra Madre was incorporated with a population of 500 citizens. In the late 1800s and early 1900s, the City of Sierra Madre's Downtown developed with commercial buildings, churches, the Sierra Madre Villa Hotel, and more.

In the early 1900s, residential development in Sierra Madre was characterized by the development of large two story homes built on large lots. These two story homes were built in the Craftsman and Victorian architectural styles. Many of these historic homes remain well preserved in Sierra Madre's residential neighborhoods. The 1930s-1940s saw a transition from Sierra Madre's large two story Craftman and Victorian homes to the development of "good"-quality stucco homes on smaller lots in closer proximity. In these decades, Sierra Madre moved closer to the present day suburban community built form. The 1950s-1960s saw significant residential growth in Sierra Madre. In this post-war period, comfortable single family homes were developed in close proximity on smaller lots. As of 2020, 76% of residential units in the City are single family homes and 62% of all residential units are owner occupied.

Since the 1960s, residential development in Sierra Madre has been characterized by infill development in the main town and residential expansion into hillside areas. Most multifamily apartment buildings were built in Sierra Madre from the late 1950s to the late 1970s. A smaller amount of multifamily apartment buildings were built in Sierra Madre in the 1980s, 1990s, and 2000s. The majority of multifamily apartment buildings in Sierra Madre are located along Sierra Madre Boulevard, Mariposa Avenue, Esperanza Avenue, Highland Avenue, and Suffolk Avenue. Multifamily housing is located in the center of the City, on and close to Sierra Madre Boulevard

and single family areas branch out north, south, east, and west from the City center.

Most of the multifamily building stock is characterized by the garden/courtyard apartment style, bungalow court style, or the townhome style. Additionally, the majority of multifamily building stock are one or two stories tall, with only a few examples standing out at three stories tall. Mixed use development is currently unprecedented in Sierra Madre. Downtown Sierra Madre remains commercially focused. Today, the majority of Sierra Madre is built out, meaning infill development is the primary development pattern.

Due to the varying multifamily structure forms in the City, the City of Sierra Madre's Objective Design Standards groups multifamily buildings into two categories, **house scale** and **block scale**, according to their physical form and scale.

Areas with house scale buildings are originally single family neighborhoods which have been rezoned to accommodate multifamily uses. Typically in these areas, there is a variety of development types, some which represent compatible design and some which represent incompatible design. Successfully designed projects are multifamily projects designed in keeping with the original single family house scale of the neighborhood. These types of projects include well designed townhomes, garden apartments, and bungalow courts.

Blockscale areas are located mostly along commercial corridors or in industrial areas that have been rezoned to accommodate multifamily uses and mixed uses. Residential development in block scale areas is typically higher density mixed use development. These high density mixed use developments are typically a half to a full block long.



Older Bungalow Court Development in Sierra Madre



Older Garden Apartment Development in Sierra Madre



Recent Townhome Development in Sierra Madre



Recent Townhome Development in Sierra Madre



House Scale Context



Block Scale Context

BEST PRACTICES

The five best practices identified in Exhibit B of The Arroyo Group's Regional Objective Design Standards Research Memorandum (attached to this document as Appendix E) are listed below. The City of Sierra Madre Objective Design Standards take these regional best practices into account.

- 1. Provide guidelines or statements of intent along with objective standards.** The SGVCOG's Regional Objective Design Standards are based on statements of intent which clarify the intent of each standards section. Cities may choose to allow variations to objective design standards as long as the project matches the intent statement for the applicable standard.
- 2. Provide options of different strategies to meet the intent of standards.** Developers may choose the standard which suits the design of their development best.
- 3. Use clear diagrams along with photographic examples to represent standards.** Clear graphics and imagery will provide as much clarity as possible for developers who are adapting their projects to meet the objective design standards.
- 4. Provide definitions for architectural terms.** For complex architectural terms, the provided definition will provide clarity where needed, making the objective design standards understandable to a variety of audiences.
- 5. Take into account the context of unique cities and districts to ensure that standards are apt.** Fieldwork in a variety of contexts representative of the San Gabriel Valley helped inform the standards. Different objective design standards will be applicable in different contexts, such as smaller scale neighborhoods versus main street commercial corridors.

House Scale vs. Block Scale

House Scale buildings contribute to a smaller-scale, neighborhood-oriented environment. These buildings are generally up to three stories in height, maintain setbacks from the street or sidewalk, are compatible

with traditional residential patterns, and achieve densities less than roughly 40-50 units per acre. House Scale buildings often resemble the massing, rhythm, and proportions of detached houses, even when containing multiple units. Objective design standards which are especially applicable to house scale buildings include residential privacy, frontage types like patio, porch, and stoop, and private open space types. House Scale building types include:

- Multiple detached dwellings on a lot
- Duplexes
- Triplexes
- Fourplexes
- Bungalow Courts
- Courtyard Apartments
- Rowhouses
- Townhouses
- Small-scale mixed-use buildings with neighborhood-serving ground-floor uses

Block scale buildings contribute to a larger-scale, urban environment, often occupying most or all of a city block. These buildings are typically taller and broader in massing, are built close to or at the street or sidewalk, and create continuous façades that define the public realm. Block Scale buildings commonly feature mixed-use configurations, with non-residential uses on the ground floor and residential units on the upper stories, supporting active commercial corridors and higher-density neighborhoods. Objective design standards which are most applicable to block scale buildings include building breaks, ground floor minimum heights, wall plane depth, transparency, stepbacks, common open space types, and frontage types such as shopfront and common entry. Block Scale building types include:

- Mid-rise Buildings
- Podium Buildings
- Wrap Buildings

HOUSE AND BLOCK SCALE ZONES

House Scale Zones

Zones that contain buildings that contribute to a smaller-scale, neighborhood-oriented environment. House scale buildings include multiple detached dwellings on a lot, duplexes, triplexes, fourplexes, bungalow courts, courtyard apartments, rowhouses, townhouses, and small-scale mixed-use buildings with neighborhood-serving ground-floor uses.

House Scale Zones in Sierra Madre: Medium/High Density Residential (R-3-13) Zone, High Density Residential (R-3-20 and R-3-30) Zone, **Manufacturing (M) Zone**

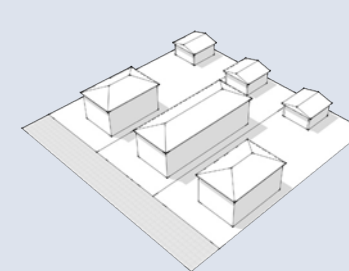

Two- to Four- plexes

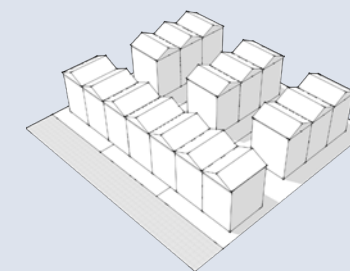

Rowhomes

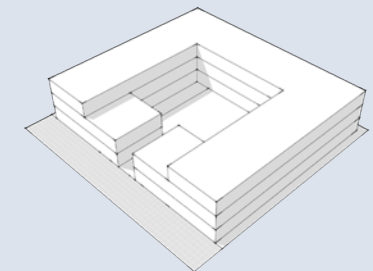

Courtyard Apartments

Block Scale Zones

Zones that contain buildings that contribute to a larger-scale, urban environment, often occupying most or all of a city block. Block scale buildings include mid-rise buildings, podium buildings, and wrap buildings.

Block Scale Zone in Sierra Madre: **Commercial (C) Zone**

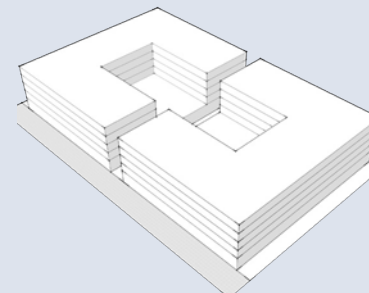

Podium Mixed-Use

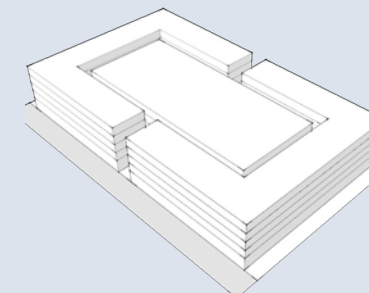

Wrap

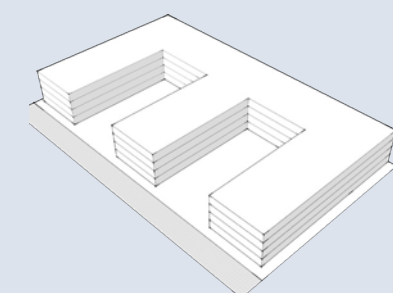

Multiplex

House and Block Scale Zones

Introduction

STANDARDS DEVELOPMENT PROCESS

Four cities, Sierra Madre, Alhambra, La Puente, and Duarte, participated in the development of the SGVCOG's Regional Objective Design Standards. Each of the four participating cities features a different planning and design context. Diverse input from the participating cities informed the development of strong objective design standards which are applicable across the San Gabriel Valley.

Input from the four participating cities along with information gathered during the background research phase form the base of knowledge upon which the SGVCOG Regional Objective Design Standards were developed. The City of Sierra Madre's Objective Design Standards were adapted from the SGVCOG's Regional Objective Design Standards. The Arroyo Group Team created a comprehensive Regional Objective Design Standards Research Memorandum (attached to this document as Appendix E) which includes findings from four areas of research:

1. Existing regulatory context, design standards and experience implementing design standards in each city
2. Best practices in objective design standards from other jurisdictions and regions in California
3. Fieldwork into the built context and character of the major growth areas in each of the three participating cities
4. Identification of existing projects in the San Gabriel Valley which embody the application of potential design standards

Exhibit A of the Memo describes existing design standards in three participating cities, Sierra Madre, Alhambra, and Duarte. La Puente joined as a participating City later in the project process, after our background research was completed. This exhibit includes all existing objective design standards and relevant development standards in each City, organized by topic for comparison.

Exhibit B (Comparison Objective Design Standards) of the Memo presents an evaluation of other objective design standards used at the municipal and regional level. While there is wide variety in the format of these

documents, The Arroyo Group Team was able to glean five key best practices, which are expounded upon on the [previous](#) page.

Additionally, The Arroyo Group Team conducted fieldwork within the cities of Sierra Madre, Alhambra, and Duarte. Exhibit C identifies the specific locations where fieldwork was conducted in each City. In Exhibit D, The Arroyo Group Team surveyed districts in each City where growth and development is most expected, such as the areas shown in images at right, to determine prevailing character features that may need to be reflected in objective design standards.

Exhibit E contains a field evaluation of individual projects in the three cities. Key design issues were identified for these projects, for consideration when developing the objective design standards.

Exhibit F identifies other projects in the San Gabriel Valley which present good examples of the application of particular design guidelines and/or standards. The projects include examples of:

- Mixed-use developments with stacked flats above a ground-floor retail and parking podium
- "Wrap" style residential and mixed-use developments with stacked flats surrounding a central parking garage
- Master-planned communities
- Townhome developments
- Side-by-side double duplexes
- Courtyard multifamily developments

Based on research from the Memo, the Regional Objective Design Standards were developed to be in alignment with current design guidelines and standards in the four cities. The Regional document's design standards reflect successfully designed projects and built character in the four cities.

Cost Factors

Design standards are essential tools that cities use to ensure buildings are of high quality, safe, and visually appealing. However, even the clearest and most objective standards can add costs and complexity to projects. If these standards are too restrictive or numerous, they can drive up housing costs or even prevent projects before they start.



Survey of multifamily residential buildings in Sierra Madre



Area for potential growth in Sierra Madre



Area for potential growth in Sierra Madre



Survey of multifamily residential buildings in Sierra Madre

Therefore, regulating design is a delicate balancing act between maximizing placemaking, enhancing overall neighborhood value, and managing project costs. According to the Association of Bay Area Governments Objective Design Standards Handbook, the following types of objective design standards which impact building massing have the greatest impact on the cost of developments:

- Requiring of construction materials
- High ground floor ceiling heights
- Frontage types which reduce building square footages
- Upper floor stepbacks which requires more complex engineering
- Projecting elements which require weatherization

- Setback standards
- Requiring certain types of open space, such as balconies and rooftop decks

In developing the Regional Objective Design Standards, it was taken into account how specific design standards could increase housing costs and impact project feasibility. However, it is also important to encourage successful, context specific developments while also prioritizing the economic feasibility of projects. The Regional Objective Design Standards were intended to encourage the creation of high quality, visually appealing buildings that benefit not only the project's residents but also the surrounding neighborhood.

Introduction

STANDARDS APPLICABILITY

The City of Sierra Madre Objective Design Standards are designed to apply to projects which qualify for State laws that may encourage or require the application of objective design standards in project review. These projects include:

- All new residential developments with two or more housing units
- The residential and commercial components of new construction mixed-use developments with two or more housing units, where at least two-thirds of the total square footage is residential. However, note that per AB 1893, for mixed-use projects with at least 500 units, only 50% of the total square footage in the project must be residential for objective design standards to apply
- However, mixed-use projects containing hotel rooms are excluded.

The standards are also designed to apply to remodeled buildings where new floor area is added. In such a case, these standards would apply to those structures and facades which are being modified in order to accommodate the new floor area; other facades or buildings on the site would not be subject to these standards.

INTERPRETATION AND DEVIATION

The next sections contain objective design standards relating to different topics. The standards are regulatory objective design standards with which all applicable developments must comply. Diagrams are provided for illustrative purposes only.

While the standards have been formulated to be "uniformly verifiable" as State law sets out, there can nevertheless be differences of opinion about whether a project has met the standard. For these cases, Government Code Section 65589.5 (f)(1) states, "... the development standards, conditions, and policies shall be applied to facilitate and accommodate development at the density permitted on the site and proposed by the development."

Projects are able to deviate from objective design standards via two processes. Developments wishing to deviate in the R-3-13, C, and M zones may receive approval with a variation from the Planning Commission, following a hearing. Developments wishing to deviate in the R-3-20, R-3-30, and RHO zones may receive approval for the variation from the Planning and Community Preservation Director as long as the proposed exception meets the intent of the standards in a better manner than strict adherence to the standard.

LOCAL ADOPTION PROCESS

Prior to adoption of these Objective Design Standards, the City compared all standards to ensure compatibility with the City's Zoning Code and General Plan. The City of Sierra Madre Objective Design Standards are formatted as a standalone document that will be adopted by reference into the City's Zoning Code. Residential developments for which objective design standards are applicable shall comply with the City of Sierra Madre's Objective Design Standards, regardless of if a site's zoning is regulated by the Zoning Code or a standalone Specific Plan.



Mixed Use Development - Objective Design Standards Applicable



Multifamily Residential Development - Objective Design Standards Applicable



Townhomes - Objective Design Standards Applicable



Duplex - Objective Design Standards Applicable

Introduction

DESIGN REVIEW PROCESS

This section outlines how individual projects are to be reviewed after adoption of the objective design standards. We cover three potential design review processes: 1. the Planning Commission (PC) Design Review Process; 2. the Modified Staff-Level Design Review Approval Process and 3. the Streamlined Ministerial Review Process.

1. Planning Commission Design Review Process

The Planning Commission Design Review process (Municipal Code (MC) Section 17.28.070 and 17.60.041) applies to applicable developments in the Medium/High Density Residential (R-3-13) zone, Commercial (C) zone, and Manufacturing (M) zone. The benefits of a PC Design Review Process include allowing public input increasing transparency through hearings, allows for limited PC discretion, and allows the developer to hear community concerns and choose to make voluntary changes to project design. In most cases, Design Review is required for new multifamily and mixed use developments. The findings for the PC Design Review process is based on subjective guidelines and standards along with adopted policies. However, amendments to the PC Design Review process must be made to comply with State law.

Upon receiving the Design Review application, Planning and Community Preservation staff will review the application for compliance with zoning regulations, the General Plan, Objective Design Standards, and subjective design guidelines adopted pre-2020. Staff may only consider subjective design guidelines if they do not reduce density or make the development infeasible. Following this review, City staff will make a recommendation to the PC to approve, approve with a variation, condition, or deny.

The PC will hold a public hearing to approve, approve with a variation, condition, or deny the application. The PC will review the application for compliance, similar to Staff review. Per the Housing Accountability Act, the PC cannot deny or condition a mixed-income application if it is consistent with the zoning regulations and General Plan. The PC cannot deny or reduce the density of a project unless not reducing it would cause a specific, adverse impact to the project's surroundings.

2. Modified Staff-Level Design Review Approval Process

The Staff-Level Design Review process with a Preliminary Design Review hearing with the Planning Commission applies to applicable developments in the High Density Residential (R-3-20 and R-3-30) zones and Religious Housing Overlay (RHO) zones.

Modified Staff-Level Design Review provides a faster review period, more consistent reviews, more certainty in the review process, and a reduced staffing need with less Planning Commission hearings. The process is sped up with the reduction to one Preliminary Design Review hearing. This review process applies to multifamily and mixed use projects. City staff shall review the project for compliance with zoning regulations, the General Plan, Objective Design Standards, subjective design guidelines adopted pre-2020, and will review if any potential design variances are needed. The project will go through one Preliminary Design Review hearing where the Planning Commission will give comments on the design and any potential design variances needed.

City staff will make a decision to approve, deny, or refer the project to the Planning Commission for the approval or denial decision. If the development needs an administrative design variance, the Director would be able to allow it as long as the proposed exception meets the intent of the standards in a better manner than strict adherence to the standard.

Per the Housing Accountability Act, the PC cannot deny or condition a mixed-income application if it is consistent with the zoning regulations and General Plan. The PC cannot deny or reduce the density of a project unless not reducing it would cause a specific, adverse impact to the project's surroundings.

3. Streamlined Ministerial Review Process

This review process applies to multifamily and mixed use projects which are being streamlined through SB 4, SB 423, or AB 2011. If the development is in zones R-3-13, C, or M, the development will go through Planning Commission Design Review. If the development is in zones R-3-20, R-3-30, or RHO, the development will go through the Modified Staff-Level Design Review. The timeline for approval or denial is within 90 days for developments with 150 units or less, or 180 days for developments with more than 150 units.

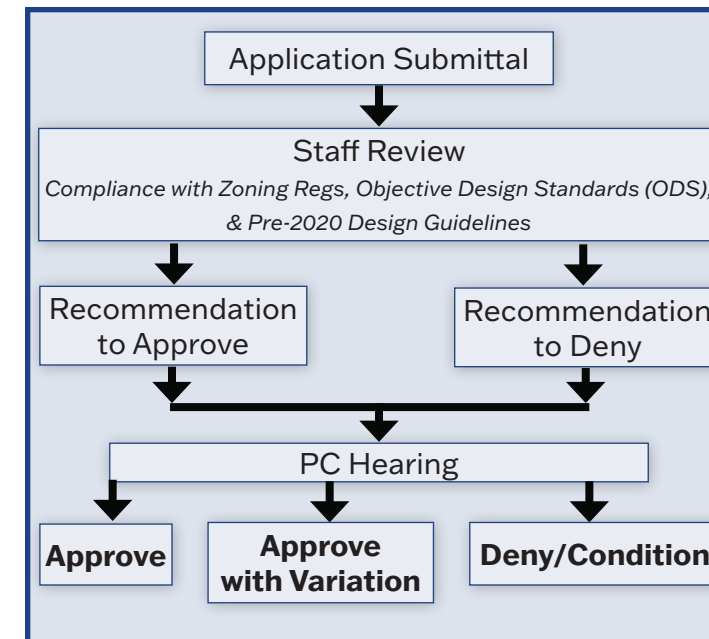

Planning Commission Design Review Process

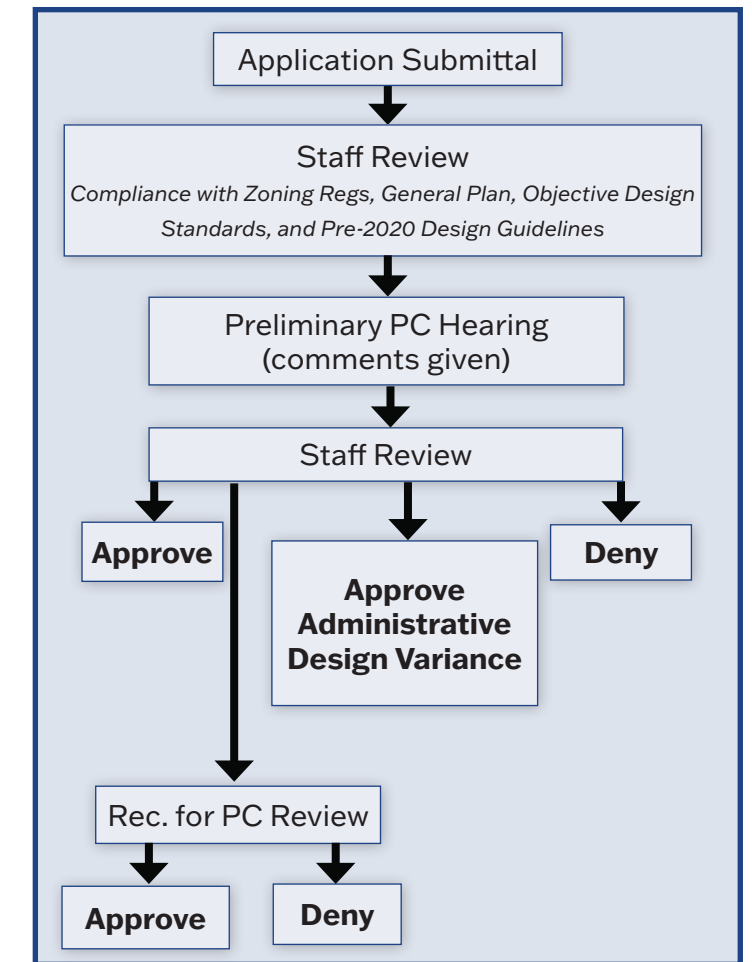

Modified Staff-Level Design Review Approval Process

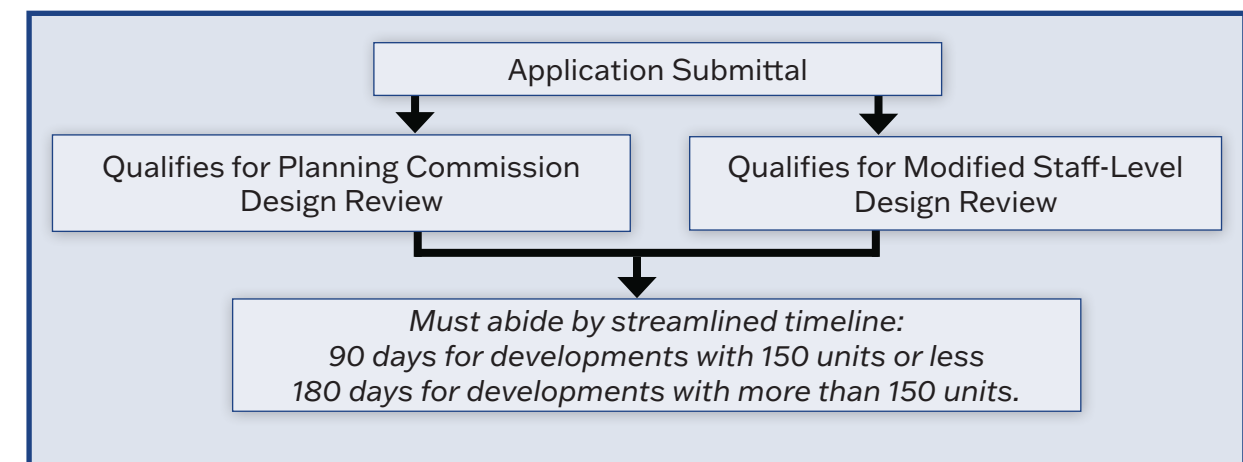

Streamlined Ministerial Review Process

Section 1: Site Planning and Access

INTENT

Buildings should be placed and oriented to reinforce a pedestrian-oriented public realm and to establish a strong visual and physical relationship with adjacent streets, sidewalks, and open spaces. Site planning should prioritize pedestrian access and activity by aligning building frontages along public streets, paseos, plazas, and other publicly accessible spaces, and by minimizing blank walls, excessive setbacks, and parking along street edges. Primary entrances, active ground-floor uses, and transparent facades should be oriented toward the public realm to support walkability, safety, and street vitality.

Site design should emphasize open spaces and the public realm, enhancing connectivity by linking building entrances to sidewalks, transit stops, open spaces, parking areas, and neighboring parcels. Access points should be legible and well integrated into the surrounding circulation network, while vehicular and service access should be designed to minimize conflicts with pedestrians and reduce impacts on the public realm. Overall site planning should activate streets and open spaces and contribute to a cohesive, human-scaled environment.

STANDARDS

Street Relationships

- 1.1 The primary entrance to all buildings adjacent to a public street shall be visible from the sidewalk and directly connected via a pedestrian pathway
- 1.2 All projects shall comply with the Frontage Type Standards in Section 4.
- 1.3 In house-scale zones, the length of any building along the primary street shall not exceed 80'. However if the ground floor is broken by an opening of at least 10' wide and 10' high, leading to a visible interior courtyard or other common open space on the ground level, the building may continue above one such opening. The length of any building, along a secondary street shall not exceed 150'.

- 1.4 In block-scale zones, the length of any building along a public street shall not exceed 350'.
- 1.5 Developments with at least 150' of frontage along the primary street shall include at least one of the following open spaces along the primary street:
 - a. A community plaza, commons, forecourt, or publicly accessible neighborhood park.
 - b. A terrace of a minimum 50' deep and 15% of the primary frontage width above the first level.
 - c. A paseo is provided from the primary street, connecting to a courtyard in the interior of the site.

All open spaces shall comply with standards defined in Section 5: and Appendices B and C, as applicable.

Residential Privacy

- 1.6 When units face each other through the open air at a distance of less than 30', windows shall be offset, or screened with landscaping as shown below, at a rate of one tree per 30' of buffer length. Landscaping shall be of sufficient density and height to provide effective visual separation between units. In house scale zones only, this standard shall also apply to units built to face existing units on an adjoining property.

- 1.7 When residential buildings are located within 10' of one another, windows on the facing building facades shall avoid unfiltered or direct views by one or more of the following:
 - a. Utilize non-transparent or obscured glazing, such as frosted or patterned glass, glass block, or non-operable opaque windows. Reflective glazing is not permitted.
 - b. Provide permanent architectural screens or affixed louvers at windows.
 - c. Utilize clerestory windows a minimum height of six feet from the ground or floor plate.



1.5: Developments with at least 150' of frontage along primary street shall include at least one of the following open spaces

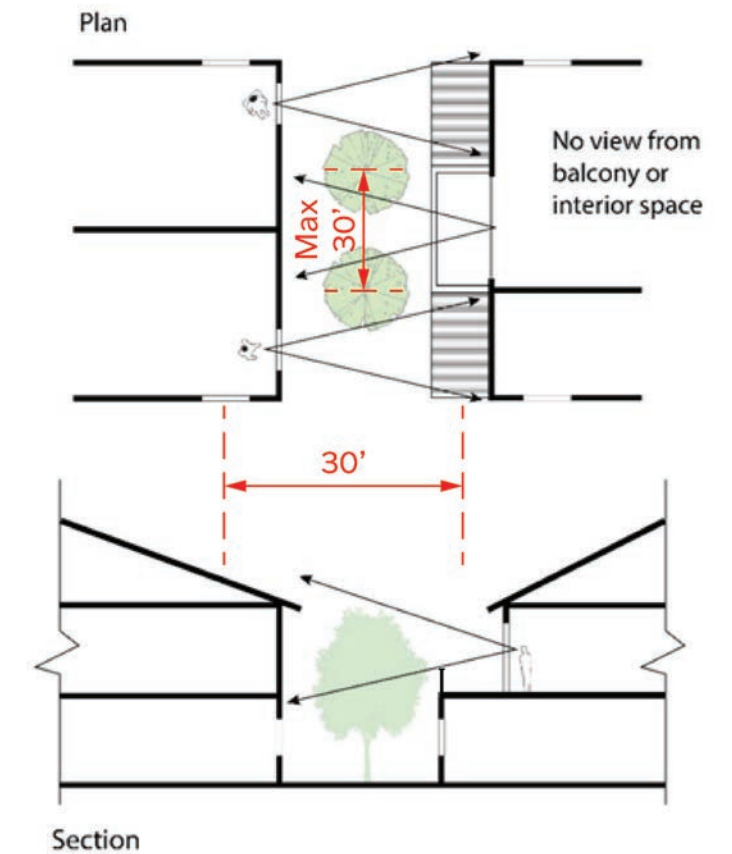

1.6: Windows within 30 ft offset and screened



1.3: Continuation of a building above an opening leading to a visible interior courtyard or common open space on the ground level.

Section 1: Site Planning and Access

Pedestrian Access

- 1.8 Pedestrian walkways shall connect all primary entries to public sidewalks. The Director may approve a shared pedestrian walkway/vehicular driveway in house-scale zones, provided that the walkway is paved with stone, tile or brick, and the driveway serves no more than eight (8) parking spaces.
- 1.9 Pedestrian walkways shall be a minimum of four feet wide, shall be hard-surfaced, and paved with concrete, stone, tile, brick or comparable material.
- 1.10 Where a required walkway is parallel and adjacent to a driveway or parking space, it must be separated from the auto travel surface by a raised curb at least four inches (4") high, bollards, or other physical barrier.
- 1.11 The primary entry shall be separated by at least 10' from any driveway or parking space.

Parking Areas

- 1.12 Surface parking areas shall be shielded from view of the public right of way by a building or a landscaped buffer as described in the Frontage Type Standards in Appendix A.6.
- 1.13 Parking structures developed as part of a private development shall not be taller than the buildings which they serve.

Vehicular Access

- 1.14 Vehicular access points to parking areas shall be taken from the side street or alley, if available, except for projects which meet the following criteria:
 - a. 350'-700' primary street frontage - 1 vehicular access point from the primary street
 - b. Over 700'+ primary street frontage - 2 vehicular access points from the primary street
 - c. Projects with less than 350' of primary frontage are allowed 1 vehicular access point from the primary street only if no side street or alley access is available.

There shall be no curb cuts along Sierra Madre Boulevard between Hermosa Avenue and Baldwin Avenue, and no curb cuts along Baldwin Avenue between Sierra Madre Boulevard and Montecito Avenue.

This standard may be waived if the Planning and Community Preservation Department determines that an alternate access point is needed for safe traffic flow, or the Fire Department determines that additional access points are needed for fire lanes.

- 1.15 Curbcutsoncornerlots shall not be located closer than 40 feet from a curb return in house-scale zones, 80 feet in block-scale zones. Additionally, curb cuts shall not be located closer than 150 feet from a curb return on Principal Arterials. Where parcel size precludes this standard, the curb cut shall be located as far from the corner as possible.
- 1.16 Sharing of driveways between adjacent properties is permitted and encouraged. Easements shall be established as necessary.
- 1.17 Driveways in house-scale zones shall be paved with concrete or pavers. Areas on driveways that are paved with permeable pavers may count toward minimum landscaping or stormwater retention requirements, provided that they comply with the standards established in those sections.

- 1.18 In house-scale zones, a one-way driveway, or two-way driveway serving up to eight (8) parking spaces, shall have a minimum 9' and maximum 11' width. A two-way driveway serving between eight (8) and twenty (20) parking spaces shall have a minimum 16' and maximum 22' width. A two-way driveway serving more than twenty (20) parking spaces shall have a minimum 20' and maximum 22' width. The maximum may be exceeded if required by the Fire Department.
- 1.19 In block-scale zones, a one-way driveway, or two-way driveway serving up to eight (8) parking spaces, shall have a minimum 9' and maximum 11' width. A two-way driveway serving more than eight (8) parking spaces shall have a minimum 20' and maximum 22' width. The maximum may be exceeded if required by the Fire Department.
- 1.20 Entry door and gates to any parking structure shall be recessed back from the face of the facade by a minimum of six inches to add shadow and visual interest, or by a greater distance from the sidewalk for traffic safety purposes as required by the Public Works Department.

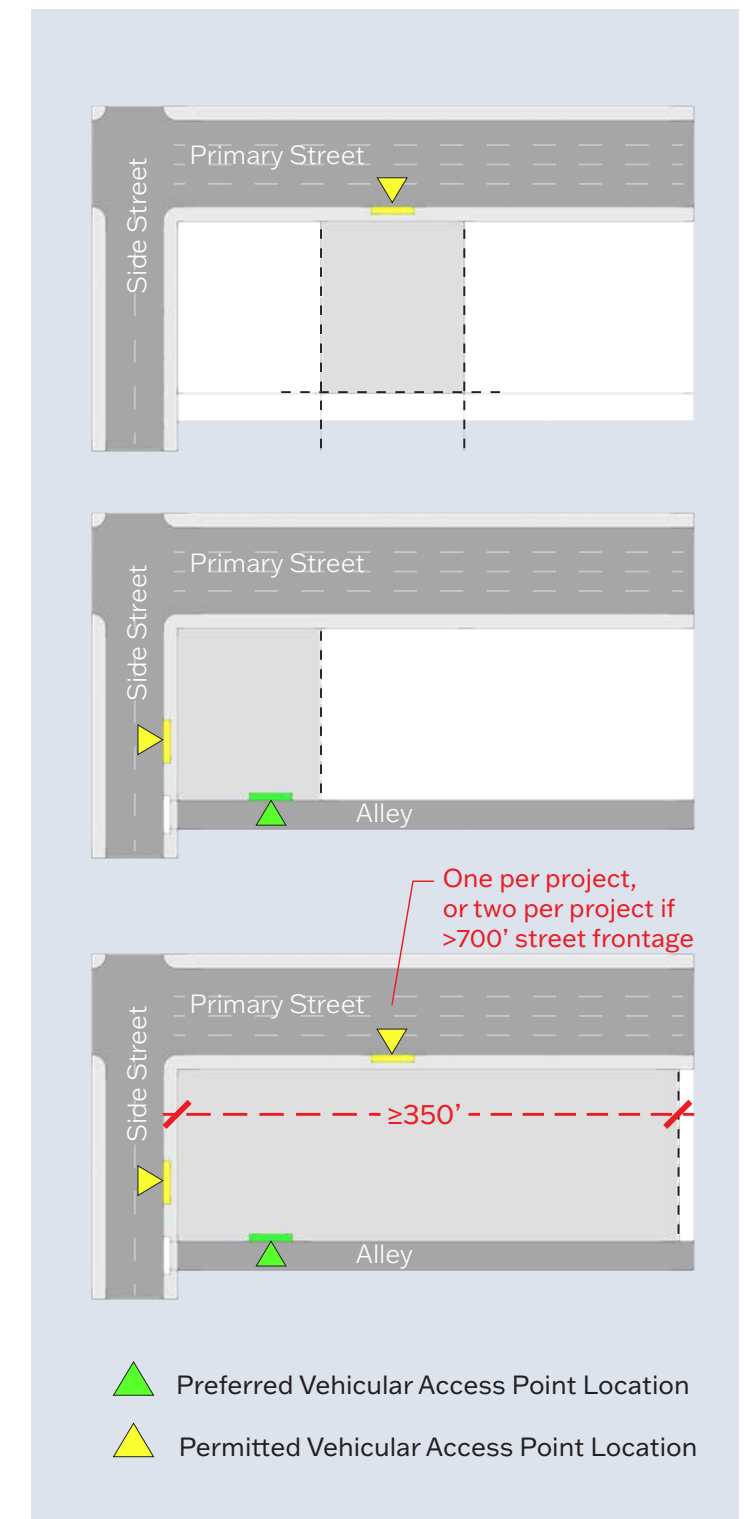

1.14: Preferred and permitted vehicular access point locations

Section 2: Building Modulation and Articulation

INTENT

The individual components of each building should contribute meaningfully to the overall architectural character, expressing a coherent form and style consistent with the project's design vision. Each project can be classified within one of two defined scales, House Scale or Block Scale, as outlined in the introduction.

Within each scale, building articulation should serve to enrich the external appearance and architectural identity of the structure while facilitating a thoughtful and seamless transition between the public realm and private spaces. Modulation and form-making should convey visual interest and a sense of rhythm, achieved through a deliberate composition of elements that reflect both the individuality of the building and its contextual relationship to the surrounding architecture. Building form and articulation should emphasize three-dimensional detailing, create visual interest on the façade, and foster a built environment that is contextually responsive.

Standards

Ground Floor Design

2.1 In block-scale zones, buildings of three stories in height or more shall be designed to differentiate a building's base from the rest of the structure. The area designed as the base should correspond to an area that has a different use from the upper floors of the building, e.g. retail, lobbies, or amenities. In the case of a single-use building, the area designed as a base may correspond to floor(s) with less private spaces on the frontage, such as living rooms in a 100% residential building, or simply the first floor of the structure.

2.2 The effect of differentiation on a building shall be achieved through the use of two or more of the following:

- a. Color, texture, or material changes along the building facade
- b. Variations, projections, or reveals in the wall plane
- c. Variations in fenestration size or pattern
- d. Decorative architectural details such as arcades, pilasters, base courses, belt courses, or cornices at intermediate levels

2.3 Where a daylit basement with an exposed wall is proposed, a minimum of two of the following design standards shall be provided along all street-facing facades:

- a. Porches or stoops
- b. Material cladding that matches the cladding of the floors above when located along the same wall plane
- c. A landscape area with a minimum width of five feet, planted with plant species that, at maturity, reach the finish floor height above the basement

2.4 For buildings that provide a top-level stepback, the stepback shall be a minimum of 10 feet, measured from the exterior wall plane along each building façade.

Circulation Design

2.5 Vertical circulation elements, including but not limited to stairwells, stair shafts, and elevator shafts, that are located along exterior walls facing a primary or secondary frontage shall be clearly expressed as visually identifiable volumes on the building façade through the incorporation of at least two of the following objective design methods:

- a. A minimum 2-foot change in wall plane (projection or recession) along the portion of the façade containing the vertical circulation element.
- b. A color, texture, or material change that clearly contrasts with the primary façade material.
- c. Decorative architectural detailing, such as vertical reveals, pilasters, or a consistent fenestration pattern, applied evenly across the full height of the vertical circulation volume.
- d. A minimum 18-inch variation in the roofline or roof plane corresponding to the vertical circulation element.

Architectural Projections

2.6 Architectural projections, including but not limited to architectural pop-outs, canopies, awnings, balconies, bay windows, eaves, chimneys, and similar architectural features, shall project a minimum of 2 feet from the exterior wall plane.

Transparency

2.7 Facades of residential floors shall have a maximum transparency of 60%. Glazing which does not meet the visible light transmittance and external reflectance standards identified in the "Transparency" definition (see Appendix D) is not permitted along the facades of residential floors.

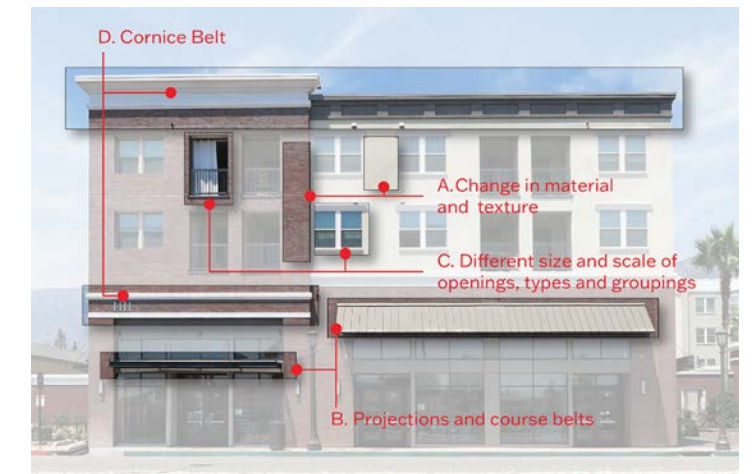

2.2: Approaches to base differentiation

Section 2: Building Modulation and Articulation

Variation in Wall-Plane

2.8 The wall-plane variations shall also meet all of the following requirements:

- Each wall-plane variation shall have a minimum depth of 2 feet
- Wall-plane variation that occur at recessed balconies are permitted
- Each wall-plane variation shall extend horizontally for a minimum height of 2 full stories, above the building base; or extend vertically from bottom to top either including the building base or not including the base
- The average depth of all wall-plane variations across each façade shall be a minimum of 4 feet
- When feasible wall-plane variations shall be located in areas that correspond to the building's programmatic floor plan, including, but not limited to, building entries, private or common open spaces, stairs and elevator cores, or corridors.

2.9 Buildings in house-scale zones shall have a maximum length of blank walls without windows, doors, or material changes of 25 feet in any direction.

2.10 Buildings in block-scale zones shall have a maximum length of blank walls without windows, doors, or material changes of 35 feet in any direction.

2.11 For block-scale buildings of three or more stories, any building façade facing a public street or alley shall include a minimum of one variation in wall-plane depth for every 50 linear feet of façade length.

2.12 In the M zone, any building facade facing a public street or alley shall include a minimum of one variation in wall-plane depth for every 30 linear feet of facade length. The wall-plane variations shall also meet all of the following requirements:

- Each wall-plane variation shall have a minimum depth of 2 feet
- Wall-plane variation that occur at recessed balconies are permitted

- Each wall-plane variation shall extend a minimum of 1 full story in height
- The average depth of all wall-plane variations across each façade shall be a minimum of 4 feet
- When feasible wall-plane variations shall be located in areas that correspond to the building's programmatic floor plan, including, but not limited to, building entries, private or common open spaces, stairs and elevator cores, or corridors.

2.13 The Director may approve an exception to the wall plane standards (2.6-2.9) when using modular construction, and when an alternative method is demonstrated that creates definition, shadow and depth along a facade.

2.14 In house-scale zones except for the M zone, linear walls of second stories shall not extend longer than thirty-five feet without an offset of a minimum of five feet for a minimum distance of ten feet.

2.15 Where permitted, third story building elements shall be located more than forty feet away from any public street and have no horizontal dimension longer than forty-five feet, per SMMC 17.29.030 (E).

2.16 Where wall-plane variations occur at balconies, each balcony shall incorporate a minimum of two of the following design standards:

- An accent pattern, material, and/or color shall be applied to the balcony projection components and supporting elements to differentiate them from the primary building façade
- An accent pattern, material, and/or color shall be applied to the balcony's recessed wall, typically oriented parallel to the building façade
- The balcony floor and railing shall be offset a minimum of four feet from the adjoining wall plane on either side of the balcony.

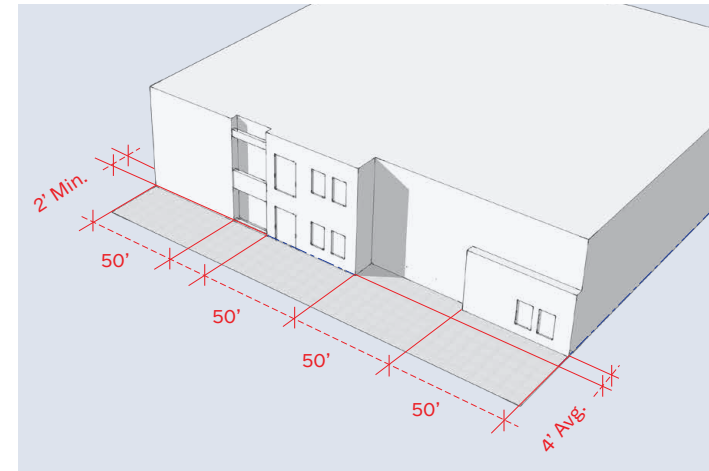

2.8.2.11: Required wall-plane breaks in block-scale zones

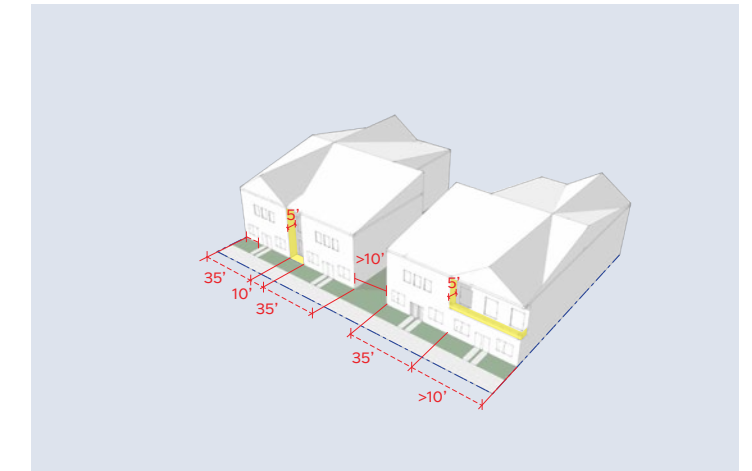

2.12: Required wall-plane breaks along street frontages in the M zone

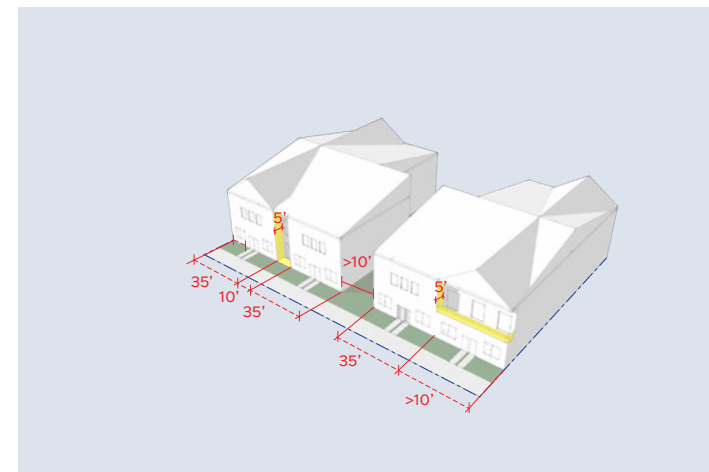

2.14: Required wall-plane breaks along street frontages in house-scaled zones

Section 2: Building Modulation and Articulation

Roof Design

2.17 New buildings in house-scale zones shall have hipped or gable roofs. The maximum roof pitch is 6:12, except for buildings constructed in the Craftsman style, which may have a pitch of up to 8:12.

2.18 New buildings in the C (Commercial) Zone shall have flat roofs with parapets along all street frontages.

2.19 The building roof height or roof form shall have a minimum of one roof variation for every 50 linear feet of building façade length. Each roof variation shall meet at least one of the following requirements:

- A change in roof plane that results in a minimum two-foot projection or recession, measured perpendicular to the façade.
- A shift in the roof line of 18 inches or greater, measured vertically from the highest point of the adjoining roof line(s).
- The use of a dormer, gable, ridge break, offset eave, or similar architectural element that creates a minimum five-foot horizontal break or relief in the roof plan before continuation of the primary roof form.

2.20 Roof forms shall terminate in a manner that accurately expresses the true building volume and prevents the appearance of a false or enlarged building mass. All roof terminations shall comply with the standards in this section.

- When a sloped roof adjoins a side wall or a shared lot line, the sloped roof profile shall terminate directly at the lot line or side wall. The sloped form shall not wrap, project beyond, or extend around the adjoining wall or lot line
- Flat roof parapets may extend along the rear façade, side wall, or shared lot line, provided the parapet accurately reflects the true building mass and does not imply additional interior volume
- Where a roof parapet transitions from or connects to a sloped roof form, the parapet shall extend to the point necessary to maintain the continuity of the sloped roof profile

- Where a roof parapet extends beyond the roof plane, the parapet return shall measure a minimum of six feet (6'), measured horizontally from the roof edge, before terminating or changing direction

Commercial Zone and Historic Resource-Adjacent Development

2.21 Any development located within the C (Commercial) zone, and any development located immediately adjacent to a designated historic resource, shall comply with the following standards:

- The building façade along the primary or secondary front of new development shall incorporate a ground floor expression line or entablature that aligns with the height of the corresponding architectural feature on the adjacent historical resource. Where there are two existing historical resource buildings abut the site, the resource with the taller expression line applies.
- The height within the first 20 feet of the development shall be no more than 15 feet greater than the historic resource.
- The side setback shall match the side setback of the historic resource, up to a maximum of 15 feet.
- The street-facing setback of the 20 feet adjacent to the historic resource shall be no less than the average of the minimum permitted setback on the development property, and the existing setback of the historic resource.

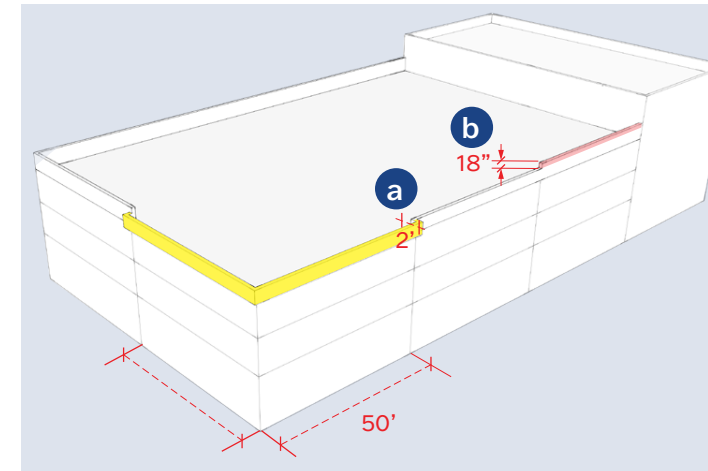

2.19 a,b.: Roof form variation options

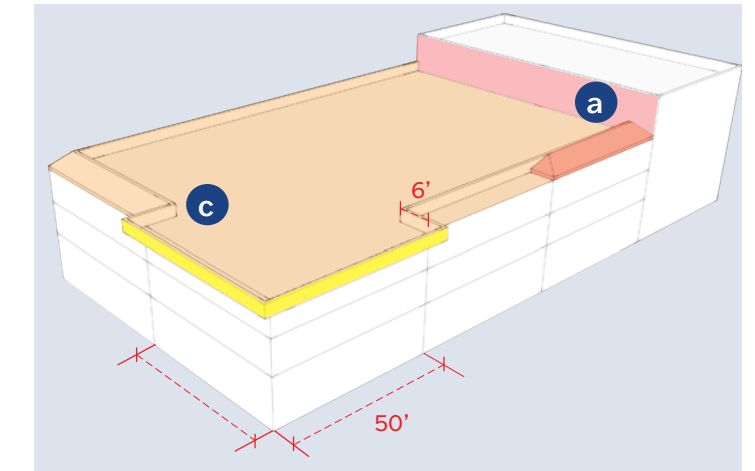

2.20 a,c.: Roof termination

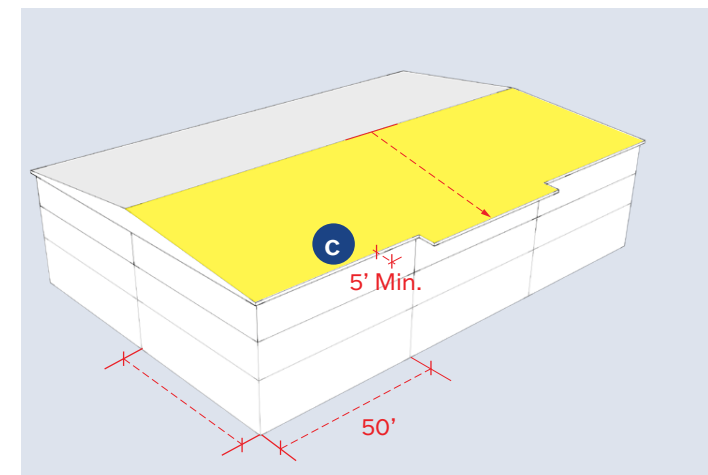

2.19 c.: Roof form variation options

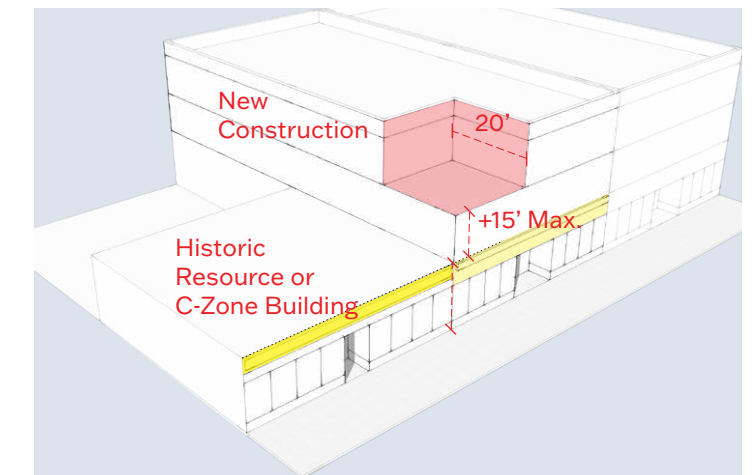

2.21 a,b: Expression Line and Transitional Height adjacent to historic resources or C zone buildings

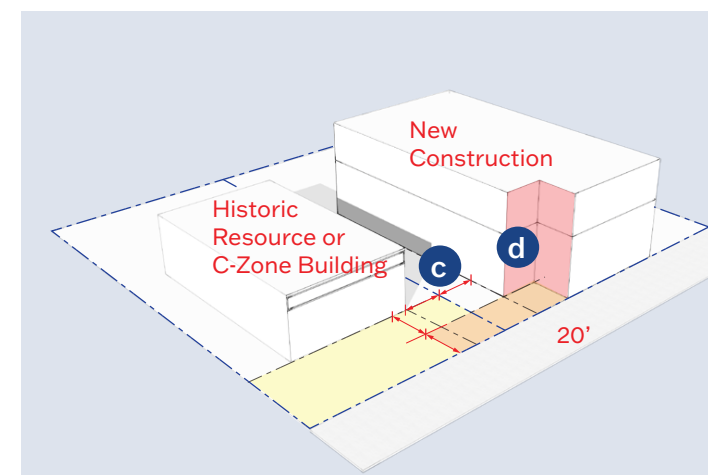

2.21 c,d: Setback requirements adjacent to a historic resource or C zone building

Section 3: Materials, Finishes, and Color

INTENT

The selection of materials, finishes, and colors shall embody a cohesive visual identity, ensuring that all architectural elements work in harmony to create a unified and refined composition. Building colors and materials should reflect and complement the character of the surrounding neighborhood.

Materials must be chosen not only for their aesthetic qualities but also for their enduring performance—demonstrating resilience, longevity, and ease of maintenance over time. Color palettes should contribute to the vibrancy and visual richness of the community while maintaining compatibility with adjacent structures and businesses.

Exterior materials and finishes are to be of professional and high-quality grade, appropriately aligned with the building's architectural style, scale, and character. Particular emphasis should be placed on the use of tactile, human-scaled materials at the building's base, where detail, texture, and craftsmanship are most perceptible to the passerby, thereby enhancing the pedestrian experience and reinforcing a sense of material authenticity.

STANDARDS

Materials

3.1 A minimum of two distinct exterior materials shall be used on any building façade, exclusive of glazing, railings, trim, or other architectural features. An exception to this standard may be permitted by the Director only when a single material is of a high-quality grade, durable, and is professionally applied with a finish that demonstrates superior craftsmanship, texture, and proportional detailing.

3.2 If a base material is utilized, the allowable materials shall be limited to stone, brick, precast concrete, or porcelain tile. Refer to Standard 2.1 for designated location of base material. When a base material is applied, the following standards shall apply:

- Heavier materials, including stone, brick and precast concrete, shall be located below lighter materials, such as stucco, siding, and wall paneling, to establish a visually grounded and structurally appropriate composition
- Porcelain tile shall be used only as an accent wall or as a bulkhead material
- Base materials used as bulkhead shall have a minimum height of 18" and a maximum height of 42" for appropriate course sizing and a human-scale appearance.

3.3 All exterior storefront frames, window frames, and storefront doors shall match in either material and color, and/or color and finish. An exception to this standard shall apply only when a door is required to comply with the building code to use a specific glazing or framing material that would otherwise deviate from this standard; in such cases, only the color and/or finish shall be required to remain consistent.

3.4 Accent and trim elements, including but not limited to window trim and casings, window sills, door trim and surrounds, lintels, fascia boards, soffits, brackets, corbels, pilasters, trim moldings, parapet caps or coping, and trellis or pergola elements, shall differ from the primary exterior materials in material, color, or texture.

3.5 Material changes shall not occur at building corners. The same material shall continue around the corner for a minimum distance of six (6) feet or at a logical termination point where the material shall extend to the next change in the wall plane.

3.6 Material transitions shall comply with the following standards:

- Material transitions along building facades shall occur on the inside corners where a change in plane is present.
- When material changes occur on the same plane, the transition shall be delineated by a trim, cornice, reveal, or other architectural elements that provide separation between materials.
- At the building base or uppermost floors(s), material transitions shall occur only where a change in plane is at least two inches from the primary wall surface.

Finishes

3.7 All exterior wall surfaces shall be finished with high-quality, durable materials designed and installed to ensure long-term performance. The following standards shall apply:

- Exposed wood materials shall be sealed, stained, or painted with a weather-resistant finish
- Wood siding materials shall be factory-finished or field-finished in accordance with manufacturer specification
- Stucco shall be applied using a minimum three-coat system (scratch, brown, and finish coats) or a two-coat system over lath, in accordance with ASTM or manufacturer's standards
- Stone veneer shall be natural or manufactured masonry units mechanically fastened or supported by a shelf angle where required
- Precast concrete panels shall have an integral color and sealed finish
- Metal wall panels shall be factory-finished with a high-performance coating such as a PVDF (Kynar) or equivalent
- All exterior paint, stain, or protective coatings shall have a minimum manufacturer-rated lifespan of 10 years



3.1: Superior finish and detail on single-material building



3.3: Consistent color and materials for trim elements



3.6: Material transitions along inside corners or with trim element

Section 3: Materials, Finishes, and Color

- 3.8** The following exterior materials and finishes shall not be permitted on any building façade:
- Fluorescent, neon, or reflective colors or materials shall not be permitted.
 - Unfinished concrete masonry unit (CMU) block or unfinished precast concrete shall not be permitted
 - Unfinished lumber or exposed panel sheathing shall not be permitted
 - Metal, vinyl, or composite materials with a faux, artificial, or synthetic imitation of natural materials shall not be permitted
 - Natural materials in their natural state, including but not limited to stone, brick, or copper, that are painted or coated with color shall not be permitted

Color

- 3.9** No more than two (2) primary colors and two (2) secondary colors shall be permitted on any building façade. Primary colors shall be applied to the main body of the building and its major volumes, while secondary colors shall be limited to accentuating architectural elements and details. The following standards shall apply:
- Secondary colors shall not exceed 20% of **each facade of the building**
 - For block-scale projects, one (1) additional color may be permitted, which may be applied as either a primary or secondary color
 - Each masonry, stone, or precast concrete material incorporated on the building façade shall count toward the maximum number of permitted primary or secondary colors
 - Artwork and murals incorporated into the project shall be exempt from this standard
- 3.10** Primary colors shall consist of colors within the following families: white, off-white, beige, taupe, tan, brown, gray, muted green, rust, ochre or olive. Fluorescent, neon and highly reflective colors are prohibited on building facades. Metallic colors shall not be used as a primary color.
- 3.11** Trim, windows, doors, storefronts, and key architectural shall differ in color than the adjacent wall surface.

Character

- 3.12** For partially submerged parking podiums and daylight basements that project above grade, the following material and color standards shall apply:
- Where basement walls are aligned with the upper floor levels, then material cladding and/or color shall match the cladding of the floor(s) above.
 - Where basement walls are offset from the upper floor levels, the material shall be distinct from the remainder of the façade above and shall project a minimum of 1 inch from the wall surface, with an appropriate transition detail provided at the interface.
 - Basement ventilation louvers shall have a color finish that matches the adjacent basement walls.
- 3.13** Materials for mechanical screening elements shall **match** the building's exterior materials, including roofing material **in material and color and/or color and finish**. The material shall be solid or composed of no more than 23% open area, evenly distributed. If metal materials are used for screening, the same exterior finish standards shall apply in accordance with 3.7.
- 3.14** Exposed rain gutters and downspouts shall be finished in an accent color consistent with the building's secondary color palette or shall be concealed by matching the color to the adjacent exterior walls. All such elements shall comply with the exterior finish standards set forth in 3.7.

- 3.15** Roof materials and colors shall complement the materials and colors of the building façades and shall provide a durable, weather-resistant finish in accordance with the following standards:
- A weather-resistant roofing product rated for a minimum service life of twenty (20) years, including but not limited to metal roofing, clay or concrete tile, slate, architectural asphalt shingles, or an equivalent material approved for the project's climate zone, shall be used for all primary roof surfaces.
 - All visible roof surfaces shall utilize the same primary roofing material, except where a distinct architectural design feature is used, such as an accent roof, tower element, or entry overhang.
 - Roof colors shall complement exterior wall colors, trim, and architectural accent features across all elevations.
 - Roof colors and finishes shall be limited to matte, low-sheen, and non-reflective coatings to reduce glare, unless required to meet applicable solar-reflectance or cool-roof standards.
- 3.16** Vehicles in parking structures shall not be readily visible from a public street or publicly-accessible open space. Any parking structure **along a public street that is** greater than 150 feet wide or 20 feet tall should additionally conceal vehicles and enhance facade quality through at least one of the following elements:
- Large public art element covering the frontage space allowing
 - Green wall or other landscape covering
 - Louvers with windows
 - Material, fenestration, and detail pattern that mimics the rest of the development

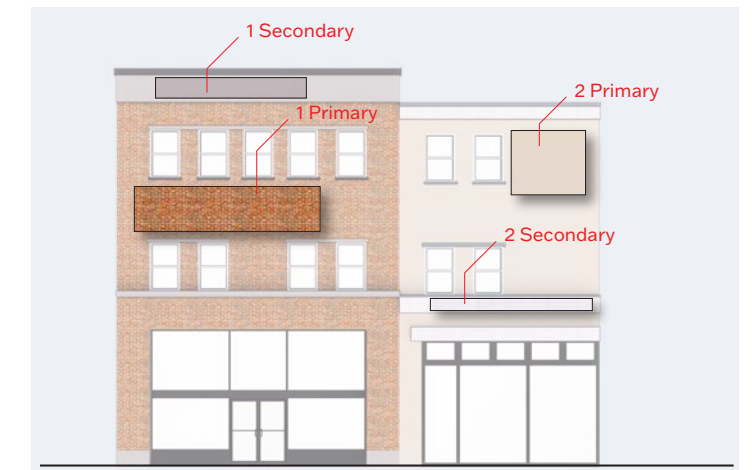

3.9: Facade Colors Permitted



3.10, 3.14: Contrast colors used to accent and complement color palette of facade

Section 4: Frontages

INTENT

The design of a building’s street frontage is among its most critical elements and is therefore subject to close regulation. Street frontages play a central role in shaping an active and safe public realm by establishing appropriate levels of visibility, engagement, and privacy based on context and ground-floor use. Ground-floor commercial frontages should promote transparency, public visibility, and permeability, while ground-floor residential frontages should provide a clear and comfortable transition from public sidewalks to semi-private outdoor spaces, entry doors, and interior living areas, with private bedrooms and more secluded spaces located away from or above the street frontage. Given the wide range of ground-floor uses and neighborhood contexts, this document defines multiple frontage types, each with tailored standards intended to support both functional performance and contextual compatibility. Street frontages may also be filled with open spaces per the requirements of Section 5. However, buildings along such open spaces may also be subject to frontage requirements (see 4.5).

STANDARDS

- 4.1 The first floor of each building where a property line meets a public street right-of-way shall be designed in accordance with one or more of the following frontage types permitted in its applicable zoning district. **General guidelines for where each frontage type is applicable are given in the table.** Each applicant shall submit a diagram indicating which frontage types are being used in different portions of each building. Standards for each frontage type are given in Appendix A.
- 4.2 Additionally, surface parking along the street frontage shall be designed in accordance with the "surface parking" frontage type.
- 4.3 The ground-floor frontage use must comply with the categories listed for the frontage type.
- 4.4 Frontage type standards are also applicable

to the first- floor frontage of buildings fronting community plazas, commons and forecourts.

- 4.5 Required driveways, utility locations, and up to 10% of the building frontage, with a design approved by the Director, need not be designed in accordance with frontage type standards.
- 4.6 All ground-floor residential units along a public street frontage shall provide a stoop, porch or patio in keeping with the standards in A.3, A.4 and A.5. The Director may exempt projects from the requirement in each of these frontage types to provide access from the sidewalk when compliance is infeasible or impractical.
- 4.7 Outdoor dining may be permitted on public sidewalks outside retail frontages subject to Encroachment Permit and local standards.
- 4.8 Outdoor dining on private property along a street frontage shall be separated from the public right-of-way by a permanent wall or movable barrier between 2 and 3.5 feet high.



4.1: Example of the diagram each applicant shall submit indicating which frontage types are being used in different portions of each building.

Frontage Type		Frontage Use	Zone					
			Block Scale Zones		House Scale Zones			
			C zone	RHO zone	R-3-13 zone	R-3-20 zone	R-3-30 zone	M zone
A.1	Shopfront	Retail, Office, Residential Amenity	Y	Y	N	N	N	Y
A.2	Common Entry	Residential Lobby and Amenity, Office	N	Y	N	N	N	N
A.3	Stoop	Residential	N	Y	Y	Y	Y	N
A.4	Porch	Residential	N	Y	Y	Y	Y	N
A.5	Patio	Residential	N	Y	Y	Y	Y	Y
A.6	Surface parking	Parking	N	Y	N	N	N	N
A.7	Structured parking	Parking	N	Y	N	N	N	N

4.1, 4.2: Table of frontage types permitted for each use and zoning designation.

Section 5: Open Space

INTENT

Open space is an integral part of development, providing access to natural light and fresh air, and usable exterior spaces with a mix of active and passive programs providing comprehensive lifestyle offerings to building users. Successful developments integrate a diversity of open space types, sizes and functions to serve a broad range of users and interests. While not all types, sizes and functions can be accommodated within a single project, projects contribute to a larger, diversified network of connected and walkable open spaces throughout the surrounding area within easy access to all residential units. Well-designed common open spaces form a transition between public sidewalks and private spaces, enhancing livability, sociability, and privacy for individual units. Within these, publicly-accessible common open spaces increase community interaction, attract non-resident visitors supporting local businesses, and overall create more vibrant places.

STANDARDS

General Open Space

- 5.1** All projects containing two (2) or more dwelling units shall include open space, or an aggregated series of open spaces, that meet the minimum area requirements established by the City. All projects containing a multi-family residential component of four (4) or more units shall include common open space, or an aggregated series of common open spaces, that meets the minimum area requirements established uniquely by each City. All areas that count toward these requirements:
- Shall be located outside an enclosed building, except for building passthroughs.
 - Shall not be used for parking, driveways, loading, or storage, except for green alleys that comply with the standards in Appendix B.
 - Shall not be located within the required front yard setback, except for patios and porches that comply with the standards in Appendix B.

5.2 All open spaces that count toward the minimum area requirements in 9.1 shall satisfy the definition and the standards of either common open space or private open space given below.

5.3 City standards related to site design and landscaping within open spaces shall apply. Additionally, the use of plant material rated as low to moderate water use as defined by the California Water Use Classification of Landscape Species (WUCOLS) is required for all planted areas, including tree planting.

5.4 All open spaces shall be thoroughly screened from abutting residential properties through planted or structured screening systems, except for key circulation and connections to adjacent areas. Refer to Section 8 for further requirements.

Common Open Space

5.5 All areas used to satisfy common open space requirements shall comply with the minimum standards of one of the following open space types. Refer to Appendix B for detailed definitions and standards of each type.

- Community Plazas and Commons
- Neighborhood Parks and Recreational Amenity Areas
- Courtyards
- Building Forecourts
- Pocket Parks
- Paseos
- Building Pass-throughs
- Alleyways / Green Alleys
- Shared Yards
- Terraces and Decks
- Rooftop Decks
- Green Roofs

5.6 All common open spaces shall include a combination of hard paved surfaces and soft landscaped areas. Refer to Appendix B for space-by-space landscape requirements for each type of open space

5.7 All common open space areas shall be designed to mitigate the effects of building glare, daytime sunlight, and heat by incorporating trees and/or shade structures, such as arbors and gazebos. It is encouraged to locate shading in open space areas where it can be most effective, such as near seating areas or along circulation routes. Constructed shade structures or projections from adjacent buildings shall cover no more than 50% of any open space, except for building passthroughs.

5.8 Programming intent shall be provided for all common open space areas. Programming shall include active and passive types of programming appropriate to the scale of the development, refer to Appendix B for space-by-space requirements for each type of open space. Such programming may include, but is not limited to:

Passive Programming:

- Walking / trails
- Outdoor dining / moveable tables and chairs
- Fixed seating (small gathering and individual hang out)
- Multi-purpose seating / flexible gathering
- Barbeque and picnic facilities
- Community gardens
- Visual / experiential gardens
- Outdoor art / art walk
- Open, pastoral green spaces
- Pop-up or rotating events and activities (eg Farmer's markets, seasonal events, etc)

Active Programming:

- Playgrounds / kids' play equipment
- Dog parks
- Spas and Swimming pools
- Interactive water features
- Sports courts (tennis, basketball, pickleball, etc)
- Sports fields (baseball, soccer, football, etc).

5.9 All common open space types whose access is listed as only "Public" in the Common Open Space Summary Matrix shall be publicly accessible during business hours of the adjacent use, or consistent with City park hours of operation, unless approved by the Director.

5.10 Top of building rooftop spaces (rooftop decks and green roofs) shall satisfy no more than 25% of the overall common open space area requirements, except for buildings on lots of 10,000 square feet or less in block-scale zones. Additionally, in house-scale zones, at least 25% of the overall common open space area requirements must be met through ground-level open spaces.

5.11 At the discretion of the Planning and Community Preservation Director, up to 25% of the overall common open space area requirements may be reduced from the project requirements if he/she determines that the project effectively uses a diversity of common open space types and scales to broaden usership by residents, attract visitors, support mixed-use development, and better contextually connect developments to key adjacent areas.

Private Open Space

5.12 All areas used to satisfy private open space requirements shall comply with the minimum standards of one of the following open space types. Refer to Appendix C for detailed definitions and standards of each type.

- Balconies (covered or uncovered)
- Patios
- Private Rooftop Decks
- Private Yards
- Porches

Section 5: Open Space

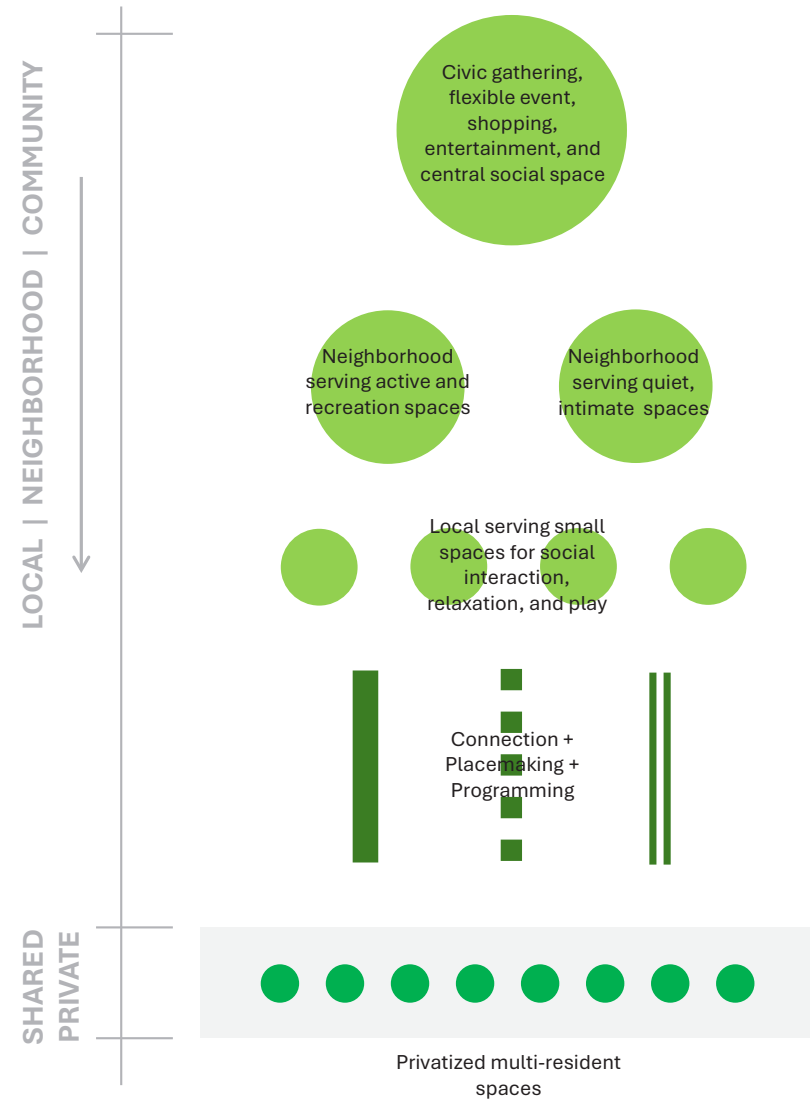

Common Open Space Hierarchy

Tier 1: Primary Open Spaces

- Community Plazas and Commons

Tier 2: Secondary Open Spaces

- Neighborhood Parks and Recreational Amenity Areas
- Courtyards

Tier 3: Tertiary Open Spaces

- Building Forecourts
- Pocket Parks

Tier 4: Open Space Connectors

- Paseos
- Building Passthroughs
- Alleyways / Green Alleys

Tier 5: Privately Accessible Open Spaces

- Shared Yards
- Terraces and Decks
- Rooftop Decks
- Green Roofs

Common Open Space Type	Users	Zone Context	Access	Development Frontage	Programming	Min. Landscaping	Min. Size
Tier 1: Primary Open Spaces							
Community Plazas and Commons	Community	Block	Public	Retail / Commercial	Passive	25% planted area, tree planting required	2,500 - 5,000 SF
Tier 2: Secondary Open Spaces							
Neighborhood Parks and Recreational Amenity Areas	Neighborhood	House or Block	Public or Shared Private	Primarily Residential, All Uses Allowed	Active / Passive	50% planted area, tree planting required	1,000 SF
Courtyards	Neighborhood	House or Block	Public or Shared Private	Primarily Residential, All Uses Allowed; buildings must define at least two edges of the space	Primarily Passive	25% planted area, tree planting required	600 SF
Tier 3: Tertiary Open Spaces							
Building Forecourts	Local	House or Block	Public or Shared Private	All Uses	Passive	25% planted area, tree planting required	200 SF
Pocket Parks	Local	House or Block	Public or Shared Private	Primarily Residential	Active / Passive	50% planted area, tree planting required	360 SF
Tier 4: Open Space Connectors							
Paseos	Connection	House or Block	Public	All Uses	Passive	15% planted area, no tree planting requirements	15' wide or wider for fire access
Building Passthroughs	Connection	House or Block	Public	All Uses	Passive	No planted area or tree planting requirements	10' wide
Alleyways / Green Alleys	Connection	House or Block	Public	All Uses	Passive	Planting areas encouraged but not required, no tree planting requirements	20' wide
Tier 5: Privately Accessible Open Spaces							
Shared Yards	Local	House	Shared Private	Residential	Passive / Light Active	25% planted area, tree planting required	Various requirements based on lot size
Terraces and Decks	Local	House or Block	Shared Private	Residential	Passive / Light Active	15% planted area, tree planting encouraged but not required	360 SF
Rooftop Decks	Local	House or Block	Shared Private	Residential	Passive / Light Active	15% planted area, tree planting encouraged but not required	25% deck area house scale zone, 75% deck area block scale zone
Green Roofs	Local	House or Block	Shared Private	Residential	N/A	75% planted area, tree planting encouraged but not required	Full rooftop minus edge setbacks

Common Open Space Summary Matrix

Section 6: Entries

INTENT

Primary building entries should be clearly identifiable, well articulated, and oriented toward the public realm in order to support pedestrian activity and intuitive wayfinding. Entries should be located along public sidewalks, paseos, plazas, or other publicly accessible open spaces, and should establish a direct, visible connection between the building interior and surrounding streets and open spaces. Architectural elements, lighting, signage, and changes in material or form should be used to emphasize entry locations and create a welcoming, human-scaled arrival experience.

Building entries should be integrated with pedestrian circulation systems and should be designed to minimize conflicts with vehicular access and service areas. Where buildings include multiple entrances, primary pedestrian entries should be distinguished from secondary or service entries through placement, design, and orientation. Overall, entries should reinforce street activation, enhance safety through visibility and activity, and contribute to an active, engaging public realm.

STANDARDS

Entry Locations

- 6.1** Primary entries to any nonresidential use, and any primary residential entry serving **multiple** units, shall be emphasized and oriented to the street, or common open spaces categorized under Tiers 1-4 in **Section 5**. Secondary entries may be from parking areas, the rear of the building or alleys.
- 6.2** Residential entrances serving more than one unit shall enter into a lobby, mailroom, shared vestibule or community space.
- 6.3** In a **house-scale zone**, the primary entry to any residential unit located along the ground floor shall be accessed from a public sidewalk, landscaped internal pedestrian walkway or paseo, **shared landing** or common open space.

Entry Design

- 6.4** Primary sidewalk entrances to public-serving commercial uses shall be open for the entire duration that the commercial facility is open.
- 6.5** Primary building entrances shall incorporate two or more of the following design elements:
 - a. A change in wall plane - recessed or projecting - of a minimum of three feet
 - b. Wall articulation, such as pilasters or cornices, trim element, or additional painted or relief detail around the entry
 - c. Projecting element above the entry (minimum depth of 2 feet and minimum width of the size of the entry door)
 - d. Break in the building massing or a portal enabling visibility into a courtyard that provides access to units.
 - e. Transparent windows or openings enabling visibility into interior spaces (a minimum of 50% within 20 ft of entrance).
 - f. A landing, deck, or stoop with a minimum depth of six feet and minimum width of eight feet, if allowed by the appropriate Frontage Type. Ensures visibility into lobbies or units, making the entry more inviting and active.
- 6.6** In mixed use projects, when residential and commercial uses are combined in the same structure, separate entrances shall be provided for each use. To improve wayfinding, different entrance design elements (from the menu in **6.5**) or different application of these elements shall be used for residential and commercial uses. Entries can be accessed from an alley, courtyard, or on a side street on sites with two or more street exposures.

- 6.7** Additionally, primary building entrances, such as lobby entrances, shall be highlighted through greater transparency than other portions of the façade, and/or a lighting strategy which emphasizes this location. Building/user identification or address signage shall also be provided in the vicinity of the entrance.

Security Features

- 6.8** Security gates and grilles, and their associated housing mechanisms, shall be fully concealed from the public right-of-way during business hours. Additionally, any such gate or grille shall be at least 75% open and transparent when deployed.
- 6.9** Permanent security bars and metal doors are prohibited on ground floor entries and anywhere on the ground-floor street or public open space frontage.



6.5: Building entry accentuated with wall articulation, massing break and portal interior courtyard



6.5: Building entry accentuated with corner location, wall articulation, projecting element and increased transparency



6.6: Separate entrances provided for mixed use developments

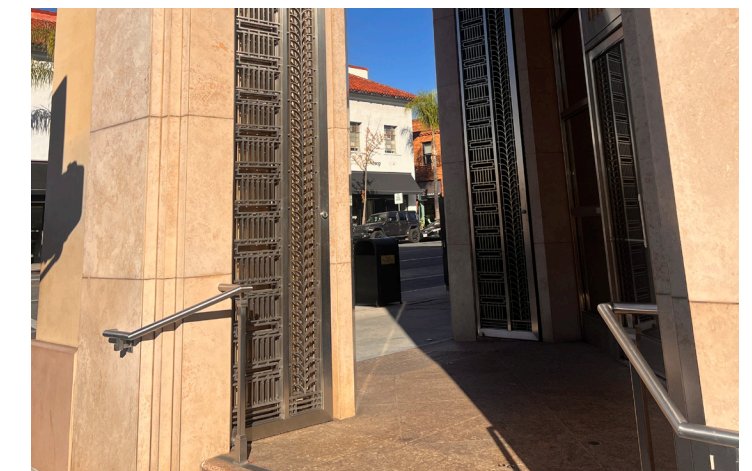

6.8: Hidden security grille

Section 7: Exterior Lighting

INTENT

Exterior lighting should be designed to promote high-quality illumination while ensuring the efficient use of energy to minimize light pollution, glare, and light trespass. Each project should have adequate lighting to support safety and visibility, with particular emphasis on walkways, driveways, building entrances, parking areas, and open spaces.

All exterior lighting fixtures should be decorative in nature and compatible with the architectural character of the building. Site lighting should be arranged and shielded to prevent adverse impacts on surrounding or neighboring properties. Where appropriate, accent lighting may be incorporated to highlight key architectural or landscape features and enhance the overall nighttime environment without generating glare or spillover.

STANDARDS

Lighting Along Walkways

7.1 Lighting along exterior walkways, driveways, building entrances, and parking surfaces shall provide a minimum illumination level of 1.0 foot-candle and shall not exceed 3.0 foot-candles, measured at the finished surface during hours of darkness, defined as one-half hour before dusk until one-half hour after dawn. All such exterior lighting shall be equipped with automatic dusk-to-dawn control systems for safety and security purposes.

7.2 Lighting type, placement, and orientation shall be designed to prevent direct glare onto adjoining properties, public rights-of-way, and the night sky. All site and building lighting shall be designed, located, and lamped to comply with the following requirements:

- Illumination levels shall not exceed 0.3 foot-candles measured beyond any property line boundary
- Not less than 90 percent of all light output shall be directed downward
- All exterior lighting fixtures shall be fully shielded and shall incorporate blinders, shades, or comparable devices to prevent glare and light spill onto adjacent properties

7.3 All exterior lighting shall utilize automatic shut-off controls, including sensors, timers, motion detectors, or equivalent technologies.

7.4 The following lighting types and design features shall not be permitted on any building:

- Internal illumination of fascias, walls, roofs, awnings or other architectural elements shall not be permitted
- Spot lighting or broadcast lighting shall not be permitted
- Animated or flashing lighting shall not be permitted
- Colored lighting shall not be permitted, except for neon lighting strips used as a accent lighting feature integrated into the building design.
- Uplighting on residential dwelling units shall not be permitted, except for focused or accent lighting solely to highlight specific architectural features of a building.

Design of Lighting

7.5 All exterior lighting shall use light sources with a correlated color temperature of 3000 Kelvin or lower to minimize blue-light emissions.

Landscape Lighting

7.6 Landscape lighting fixtures shall not exceed 4 feet in height when located within planting areas or along pedestrian pathways and shall be setback a minimum of 5 feet in any direction from residential windows, patios, or private open spaces.

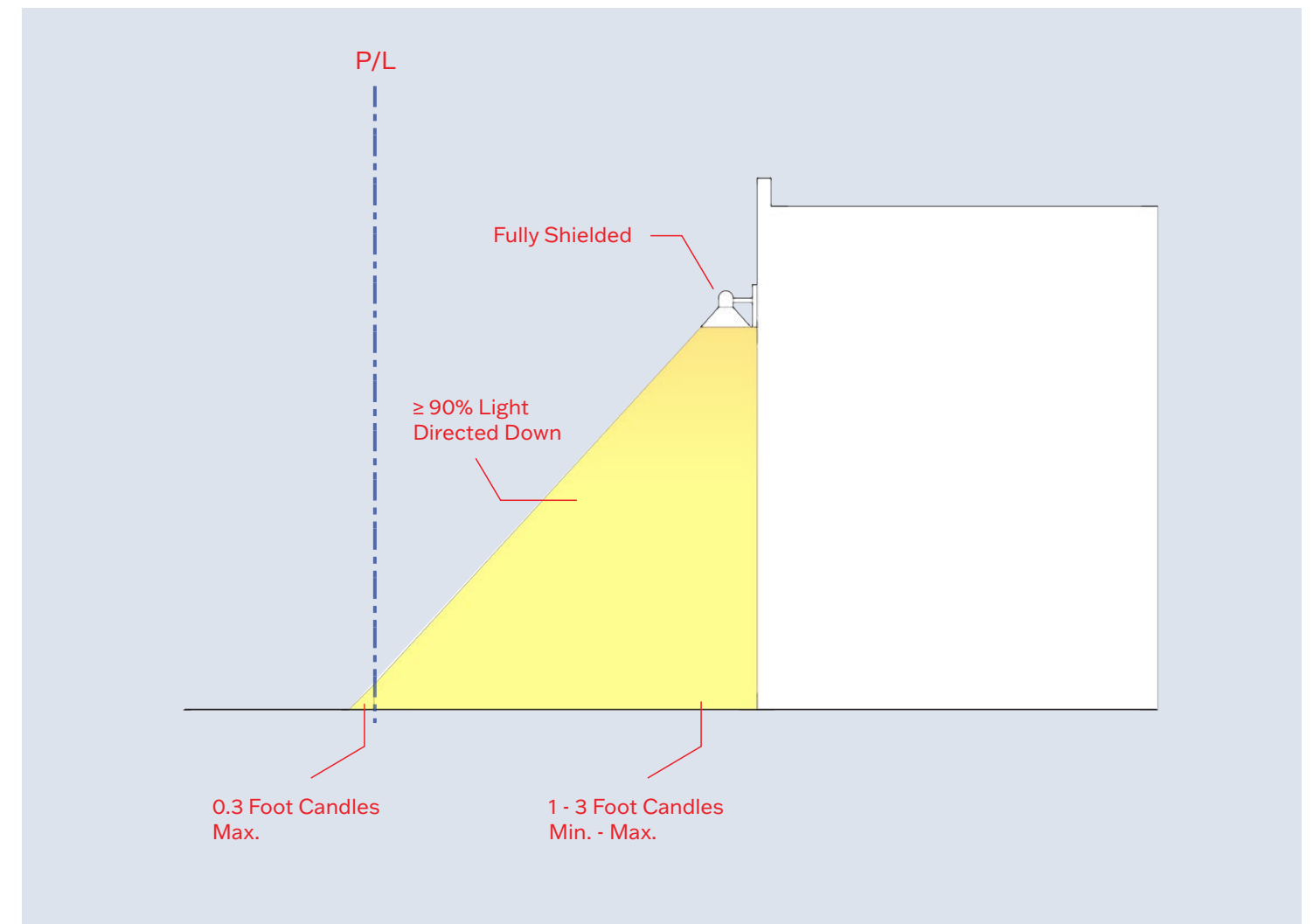

7.2: Illumination Standards

Section 8: Walls and Fences

INTENT

Walls and fencing serve an important role in shaping a cohesive and pedestrian-oriented environment. Their use supports property protection, enhances privacy, reduces noise, and contributes to an attractive visual setting. Walls and fences are appropriate for screening automobile parking, loading and storage areas, utility equipment, and for buffering residential uses from adjacent activities.

These features should remain as low as practicable while still fulfilling their screening and security functions. When used as screening elements, walls and fencing should be designed to complement the site's architectural character and incorporate architectural detailing consistent with the overall development. Wherever feasible, landscaping should be integrated with wall and fencing design to soften visual impact, reinforce site aesthetics, and improve the public realm.

STANDARDS

Screening

8.1 Surface parking lots and open parking structures shall be screened from public streets and adjacent residential properties by a continuous fence, wall, and/or landscape buffer. All required fencing and wall elements shall be designed in accordance with the applicable frontage type standards as identified in Appendix A.

Wall and Fence Height

8.2 Walls, including retaining walls, and fencing shall not exceed 42 inches in height when located within 20 feet of the front property line or edge of any public street right-of-way, whichever is greater, and shall not exceed 6 feet in height within required interior setbacks. All required fencing and wall elements shall be designed in accordance with the applicable frontage type standards as identified in Appendix A.

8.3 An exception to the maximum fence height within 20 feet of the front property line or edge of any public street right-of-way, whichever is greater, may be approved by the Director when such fence surrounds a common open space. The fencing shall be visually transparent, appropriate to the context and needed access controls and decorative.

8.4 The following fence elements are permitted to exceed the maximum height specified in 8.2 by no more than 12 inches, inclusive of pilaster caps, post caps, and integrated lighting fixtures, and shall comply with the following dimensional requirements:

- Wood, metal, or vinyl (PVC) post shall not exceed 6 inches by 6 inches in cross-section
- Masonry or concrete post / pilaster shall not exceed 18 inch by 18 inch in cross-section
- Fence posts shall be spaced a minimum of 6 feet apart, measured on-center
- Fence elements shall be compatible in material and/or color with the materials or architectural features used on the building(s) located on the site.

Design of Walls and Fences

8.5 All exposed walls shall incorporate a treated architectural finish, including, but not limited to, smooth-formed concrete, sandblasted concrete, exposed aggregate concrete, brick veneer, split-face masonry, decorative stone veneer, or a stucco-applied finish. Alternative materials or finishes that are compatible with and integrated into the design of on-site buildings may be permitted, subject to approval by the applicable reviewing authority.

8.6 All fencing materials shall be constructed of treated wood, powder-coated or galvanized steel, wrought iron, or high-quality composite materials. Vinyl or plastic fencing, barbed wire, razor wire, and electric security fencing shall not be permitted.

Chain-link fencing shall not be permitted, except when used temporarily for construction or site security during active construction activities.

8.7 Retaining walls shall be designed such that all exposed surfaces incorporate an architectural finish consistent with the materials and treatments identified in 8.5.

8.8 Fencing materials shall not utilize reflective, glossy, or glaring finishes or colors.

Location of Walls and Fences

8.9 All fencing shall be installed with the finished side oriented toward public streets and adjacent properties.

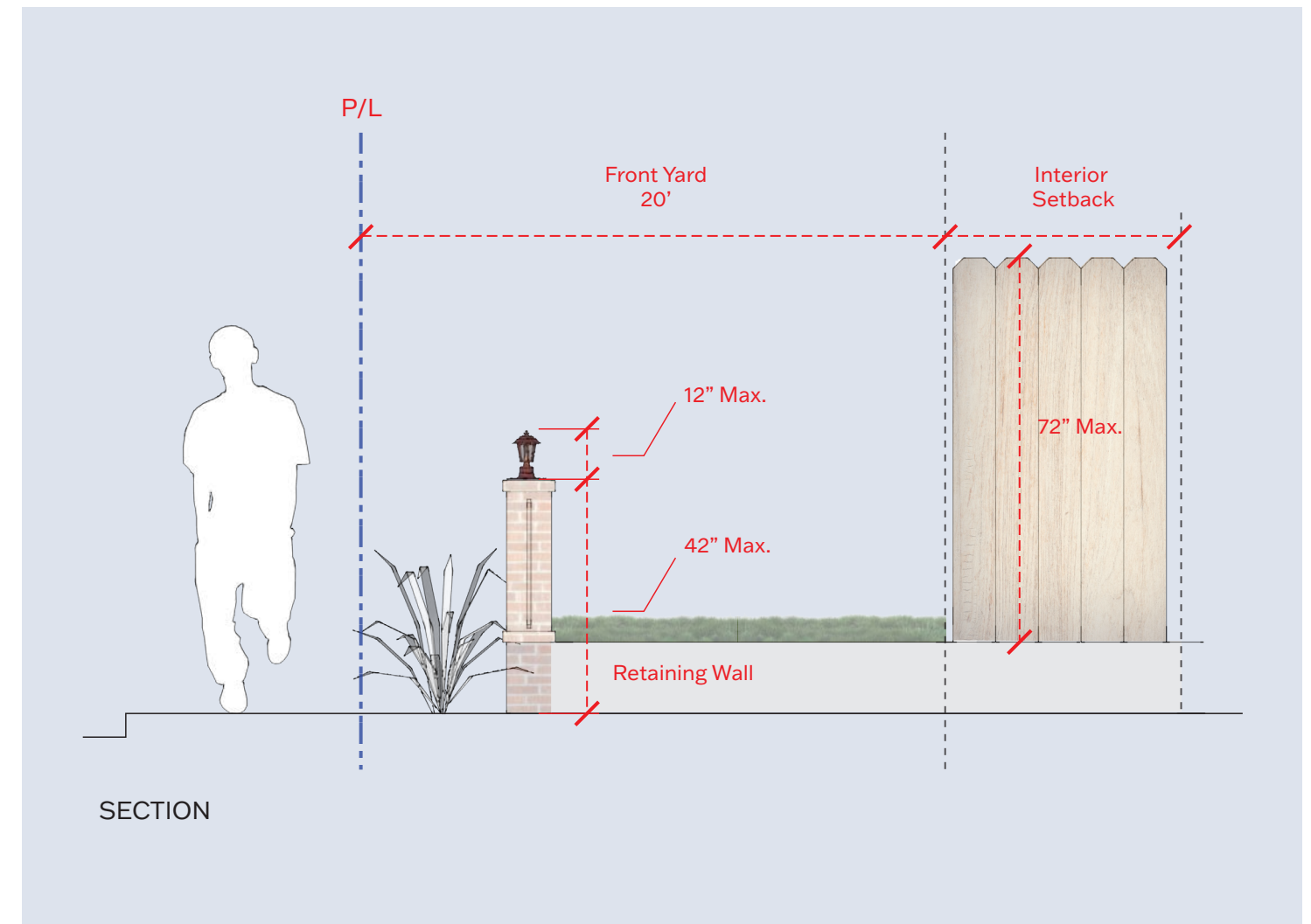

8.2, 8.3: Maximum wall and fence height

Section 9: Loading Areas, Trash and Utilities

INTENT

The design and placement of loading areas, trash enclosures, and utility equipment shall incorporate effective screening techniques to minimize visual, noise, and privacy impacts on surrounding properties and public rights-of-way. These elements shall contribute to an orderly and visually cohesive site environment. To support a high-quality pedestrian realm, commercial loading areas and trash enclosures shall be enclosed or otherwise screened and positioned out of view from public streets to the greatest extent feasible. Utility meters, electrical panels, transformers, and comparable equipment shall be sited in a manner that respects the experience of the public realm and adjacent buildings, and, when possible, located away from primary building frontages.

STANDARDS

Commercial Loading Areas

9.1 Loading areas shall be permitted only for development projects with non-residential uses, excluding office uses, that exceed 10,000 square feet of total floor area.

Screening Loading Areas

9.2 Commercial loading areas shall be screened from surrounding properties and public rights-of-way by a fence, wall, and/or landscape buffer designed to minimize visual, noise, and privacy impacts. Commercial loading areas shall be located and accessed from secondary or tertiary streets where feasible, and shall not be located along a primary street frontage.

Trash Enclosures & Location

9.3 All refuse, solid waste, recycling, compost, and green waste bins or containers shall be fully screened on all sides from public rights-of-way by a solid fence or wall with a minimum height of five and one-half (5½) feet. Trash enclosures may include one or more solid access gates, which shall remain closed at all times except during active loading or unloading operations.

9.4 Trash enclosures shall be located within two hundred (200) feet of an access point to the building they serve and shall not be located in any of the following areas:

- Within 25 feet of a required front or street-side setback
- Between any building and the public street or sidewalk
- Within required landscaped areas, pedestrian pathways, driveways, or common open space areas
- Within any required parking space

Utility Location

9.5 Roof-mounted equipment shall be fully screened by parapets or other roof structures that are at least as tall as the highest part of the mechanical equipment, or the equipment shall be set back a minimum of 10 feet from the roof edge. Roof-mounted solar energy systems and panels may be permitted without screening, subject to approval by the applicable reviewing authority.

9.6 All attached and free-standing equipment shall be fully screened from public view by fencing or landscaping that is equal to or greater in height than the highest point of the equipment, or painted to match the adjacent building structure. **If any of these options is prohibited** by applicable building, fire, electrical, or plumbing codes, **an alternate option shall be used**. Where fencing is used for screening, adequate clearance and access gates shall be provided in compliance with applicable codes. Electric vehicle charging equipment shall be exempt from this requirement.



9.3: Loading area provided an alley avoid street exposure

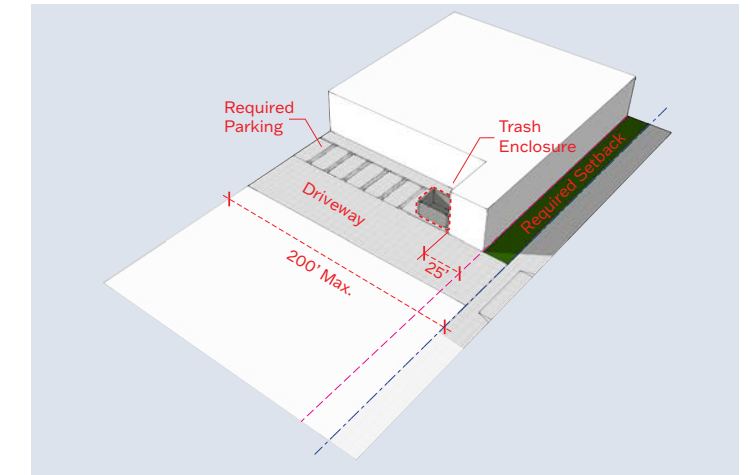

9.4: Trash enclosure location standards

Appendix A: Frontage Standards

A.1 Shopfront

Applicable Uses: Retail, Office, Residential Amenity

The main façade of the building is near the right-of-way with an at-grade entrance along the sidewalk. This frontage type is intended for active ground floor uses and has substantial glazing at the ground level. Awnings should be incorporated unless site conditions or design strategy preclude them.

Required Dimensions	
Depth, Recessed Entries (A)	5 ft max., behind building shopfront line
Distance Between Windows (B)	20 ft max.
Distance Between Entries (C)	40 ft max.
Continuation of Shopfront Frontage Type around corner (D)	25 ft min.
Bulkhead (E)	1.5 ft., 2 ft max.
Building setback from property line (F)	0 ft min., 1.5 ft max., except when using open space type.
Awning Depth (G)	6 ft min
Awning Height (H)	9 ft min., max. is the midpoint between the top of highest window of the ground floor and the window sill of the second
Transparency, Ground Floor	65% min.

Other Standards

Per CalGreen building code, awnings are required on all south-facing storefronts.

Ground-floor elevation shall be level with adjacent sidewalk.

Notes

The Planning and Community Preservation Department and Public Works Department may reduce the allowed awning depth if warranted by local conditions.

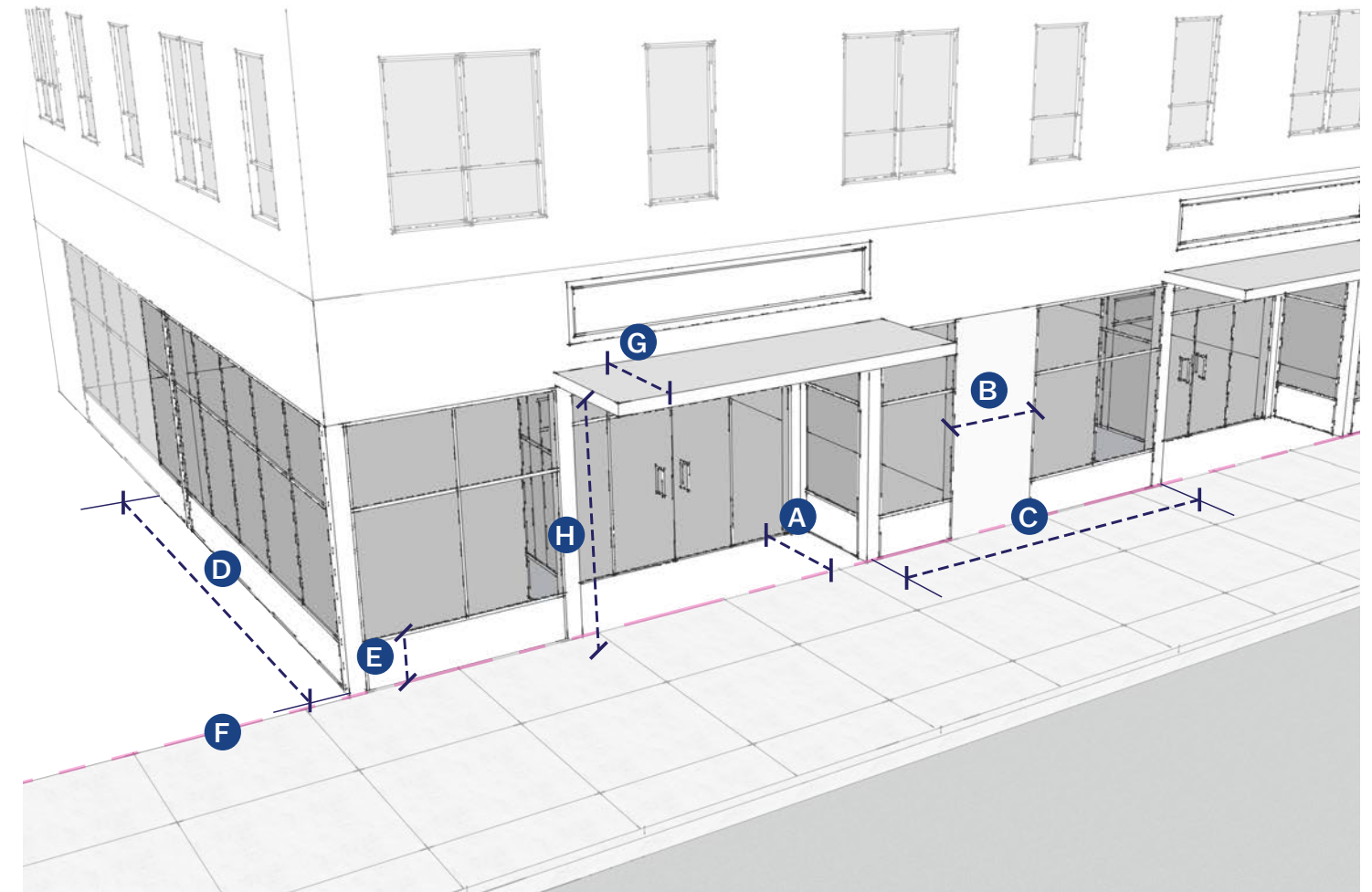

Appendix A: Frontage Standards

A.2 Common Entry

Applicable Uses: Residential Lobby and Amenity, Office

This frontage type is intended for office, civic or residential uses which are accessed through centralized building or site entries located directly on the sidewalk. The entry enters into a lobby, community room or reception area. Between entries, individual offices, gyms, meeting rooms and other such spaces line the ground-floor frontage. In developments with ground-floor office uses, common space areas are oriented toward the street in order to ensure compatibility with a transparent frontage.

Required Dimensions	
Distance Between Entries (A)	100 ft max.
Width, Entries (B)	5 ft min., 15 ft max.
Depth, Recessed Entries (C)	1.5 ft min., 8 ft max.
Planting Width (D)	3 ft min., 20 ft max.
Building Setback from Property Line (E)	Min setback applicable to the zone. 10 ft max. in block-scale zones, 20 ft in house-scale zones.
Awning Depth (F)	2 ft min.
Awning Height (G)	9 ft min.
Transparency, Ground Floor	55%

Other Standards

Planting width may be filled with movable planter boxes or with landscaping planted in the ground. Planter boxes and landscaping may not block any of the required minimum transparency of the frontage.

Pathway between sidewalk and entry shall be direct.

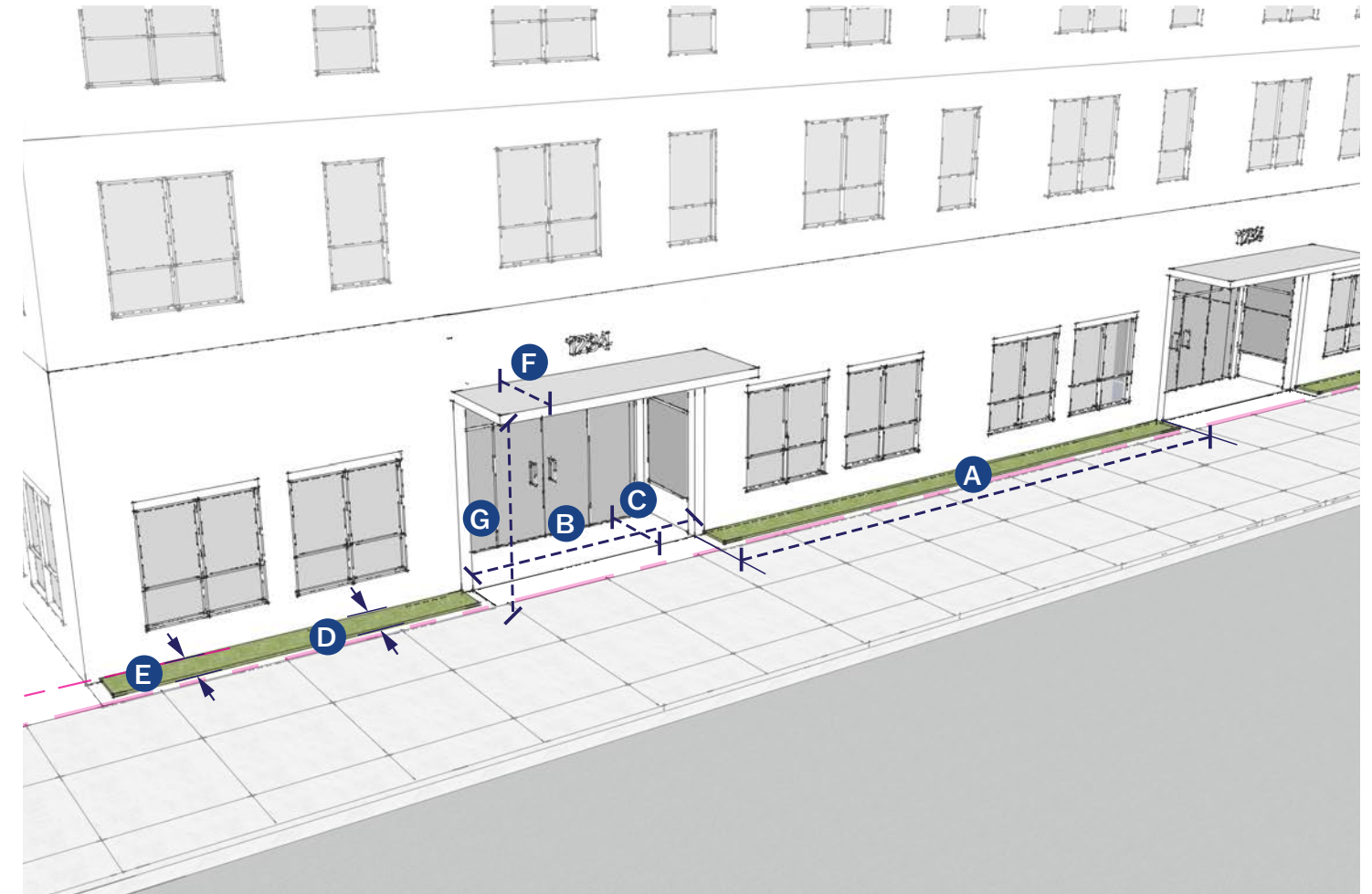

Appendix A: Frontage Standards

A.3 Stoop

Applicable Uses: Residential

The main facade of the building is near the right-of-way and the stoop engages the sidewalk. This frontage type is elevated above the sidewalk to ensure privacy within the building. The entrance is usually an exterior stair and landing.

Required Dimensions	
Width, Clear (A)	4 ft min., 10 ft max.
Depth, Clear (B)	4 ft min., 8 ft max.
Depth, Recessed Entries (C)	6 ft max.
Finish Level above Sidewalk (D)	1 ft min., 4 ft max.
Building Setback from Right-of-Way (E)	Min setback applicable to the zone.
Stoop Setback from Right-of-Way (F)	3 ft min., 10 ft max., in block-scale zones. 5 ft min., 10 ft max., in house-zones
Transparency, Ground Floor	35% min.

Other Standards

Stoop shall serve a single residential unit or building entry.

Reasonable accommodation shall be provided as appropriate.

Stairs may be perpendicular or parallel to the building façade.

Entry doors shall be covered or recessed.

All yard areas adjacent to stoops shall be filled with landscaping, and all semi-subterranean parking areas shall be hidden with landscaping.

The Director may exempt projects from the requirement in each of these frontage types to provide access from the sidewalk when compliance is infeasible or impractical.

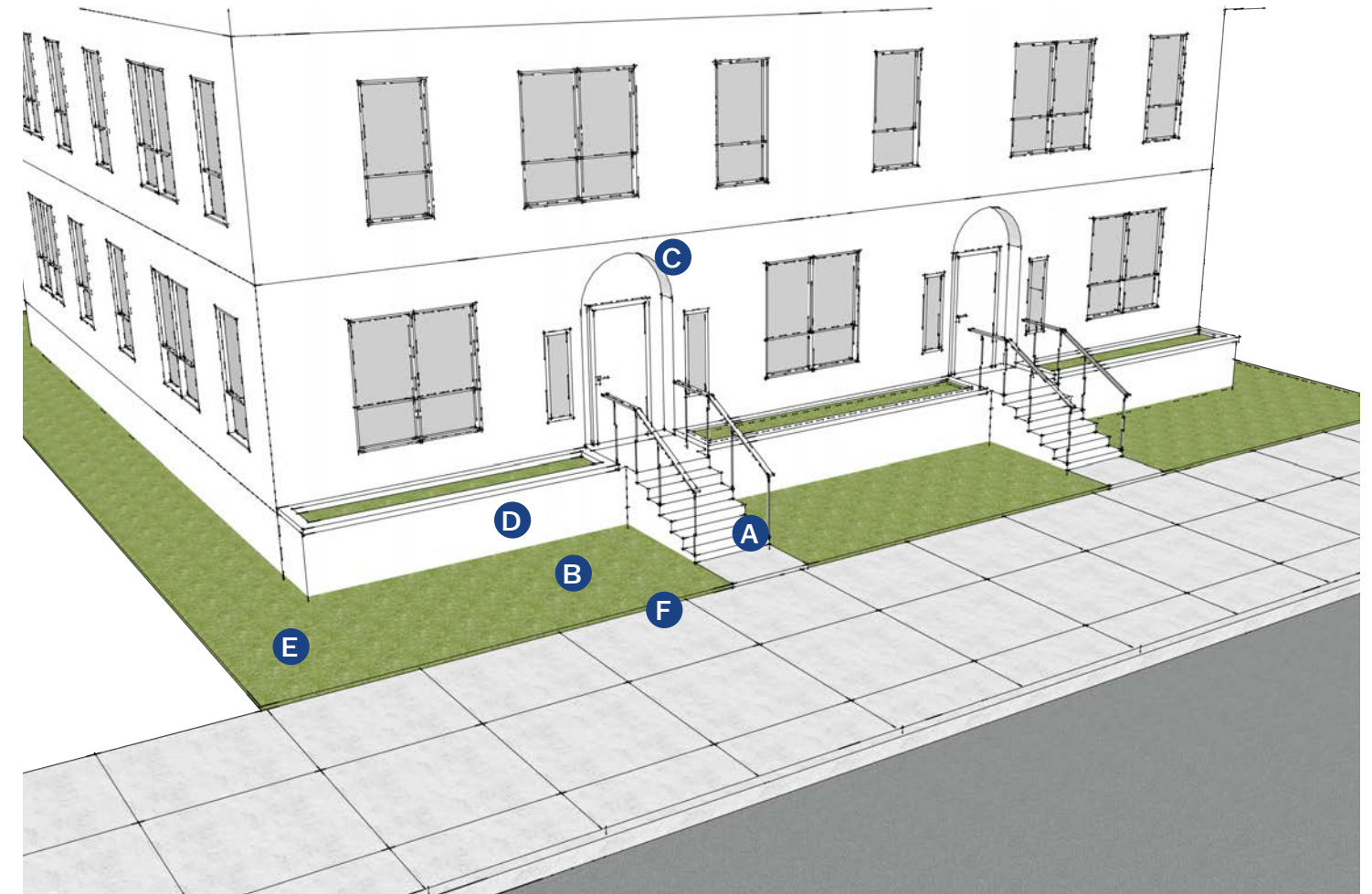

Appendix A: Frontage Standards

A.4 Porch

Applicable Uses: Residential

The front door is accessed through a decently-sized, covered outdoor living area which provides an opportunity for seating and "eyes on the street," while maintaining significant privacy for residents. The porch accentuates residential character and provides a unifying element between single-family and modest-density multifamily structures within house-scale neighborhoods.

Required Dimensions	
Width, Clear (A)	10 ft min.
Depth, Clear (B)	6 ft min., 10 ft max.
Finish Level above Sidewalk (C)	1 ft min., 4 ft max.
Distance Between Porch Elements And Right-of-Way (D)	5 ft min., Max. is the min. setback of the zone
Building Setback from Right-of-Way (E)	Min setback applicable to the zone.
Transparency, Ground Floor	35% min.

Other Standards

Porch shall serve a single residential unit or building entry.

Reasonable accommodation shall be provided as appropriate.

Stairs shall be perpendicular to the building façade.

Entry doors shall be covered or recessed.

All yard areas adjacent to porches shall be filled with landscaping, and all semi-subterranean parking areas shall be hidden with landscaping.

The Director may exempt projects from the requirement in each of these frontage types to provide access from the sidewalk when compliance is infeasible or impractical.

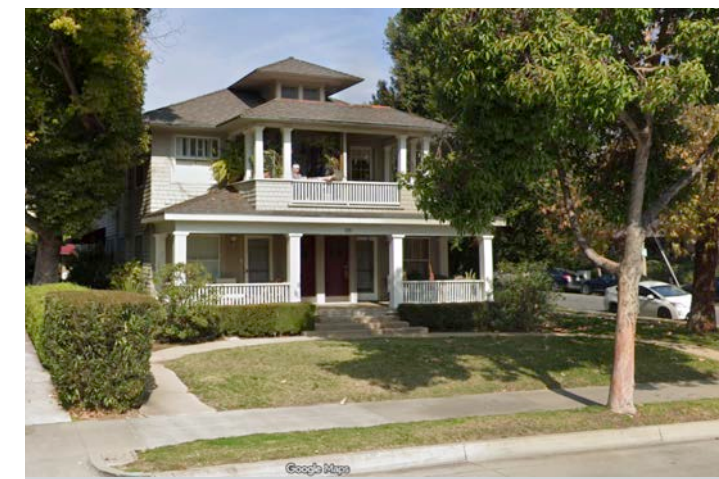

Appendix A: Frontage Standards

A.5 Patio

Applicable Uses: Residential

Ground-floor residential units are located at-grade, but to ensure an appropriate transition between public space and the unit itself, the area between the sidewalk and building becomes an enclosed private patio, visually open to the street.

Required Dimensions	
Width, Clear (A)	15 ft min.
Depth, Clear (B)	6 ft min., 10 ft max.
Depth, Recessed Entries (C)	6 ft max.
Building Setback from Property Line (D)	Min setback applicable to the zone. but no less than 10 ft., 15 ft max.
Pedestrian Access (E)	3 ft min., 6 ft max.
Landscaped Strip (F)	2 ft min.
Height of Fence/Wall (G)	1 ft min., 3.5 ft max.

Other Standards

Patio shall serve a single residential unit or building entry.

Pedestrian access area may have a gate.

Entry doors shall be covered or recessed.

If counted toward minimum open space requirements, patio shall comply with "Patio" open space type standards.

The Director may exempt projects from the requirement in each of these frontage types to provide access from the sidewalk when compliance is infeasible or impractical.



Appendix A: Frontage Standards

A.6 Surface Parking

Parking may be supplied on the surface or in subterranean, podium or above-ground structured configurations. Where appropriate, a limited amount of the street frontage may be used for surface parking. In these cases, the parking is screened by a wall and landscaping.

Required Dimensions	
Parking Facility Width (A) as a function of Lot Width (B)	30% max (primary street), 50% max (side street), up to 150 ft
Depth of Landscaping (C)	3 ft min.
Wall Height (D)	3 ft min., 4 ft max.

Other Standards

Parking access locations are subject to the standards set in Section 4.10.

Where this frontage type is not permitted, surface parking may not be located along the frontage of the project. Only a driveway accessing parking located behind another building on the site is permitted.

Walls shall be opaque and made of masonry.

Use of a filter strip, infiltration trench or other stormwater best management practice is encouraged over raised landscape planters.

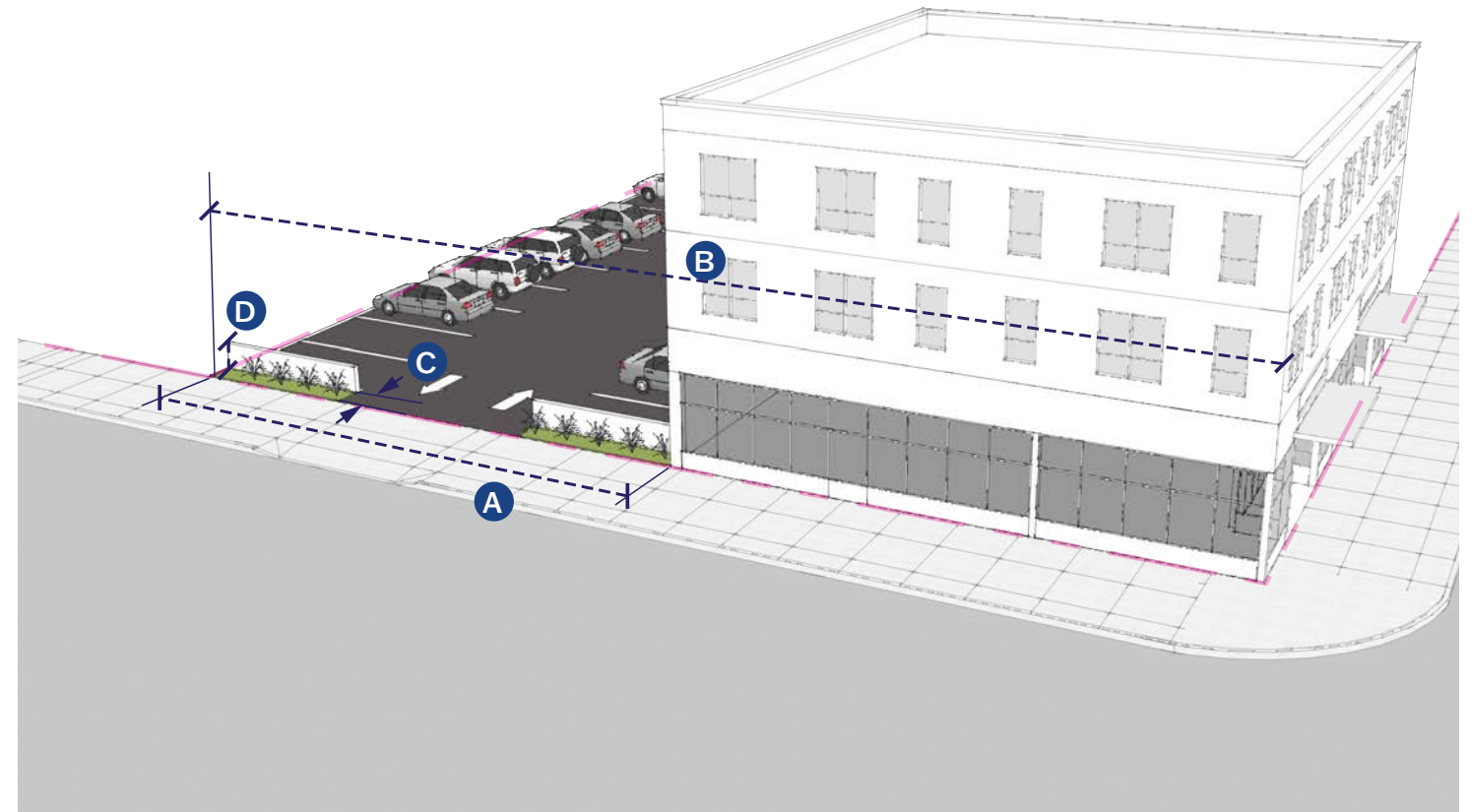

Appendix A: Frontage Standards

A.7 Structured Parking

Structured parking may occupy a limited portion of the frontage of a building in certain areas. The height is limited and design shields from direct view of cars, while also providing softening through landscaping and limited transparency. Unlike the other frontage types, these regulations apply to structured parking on any floor of the building along a public street frontage (e.g. the second floor of a mixed-use podium building).

Required Dimensions	
Parking Facility Width (A) as a function of Lot Width (B)	30% max (primary street), 50% max (side street), up to 150 ft
Depth of Landscaping on Frontage (C)	5 ft min.
Transparency, Parking Structure Ground Floor	15% min, equally distributed across structured parking elevation. All transparent openings along the ground-floor of a building shall be softened by landscaping, louvers or similar strategy.
Structured Parking Height along frontage (D)	20 ft max., (primary street)

Other Standards

Structured parking garage frontages taller than 20 ft, if allowed, shall be screened or enhanced as described in 3.15.

Where this frontage type is not permitted, structured parking may not be located along the ground-floor frontage of the project. Only a driveway accessing parking located behind another building on the site is permitted.



Appendix B: Common Open Space Types

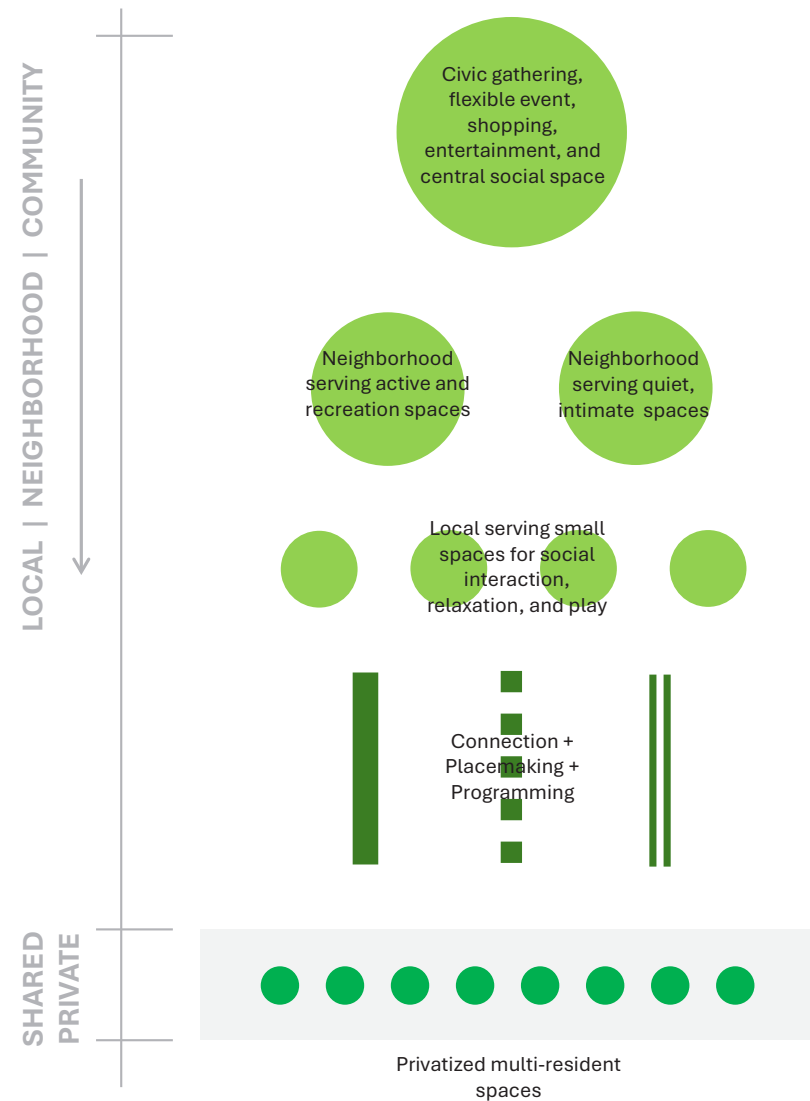

Common Open Space Hierarchy

Tier 1: Primary Open Spaces

- Community Plazas and Commons

Tier 2: Secondary Open Spaces

- Neighborhood Parks and Recreational Amenity Areas
- Courtyards

Tier 3: Tertiary Open Spaces

- Building Forecourts
- Pocket Parks

Tier 4: Open Space Connectors

- Paseos
- Building Passthroughs
- Alleyways / Green Alleys

Tier 5: Privately Accessible Open Spaces

- Shared Yards
- Terraces and Decks
- Rooftop Decks
- Green Roofs

B.1 Community Plazas and Commons

Spacious hardscaped plaza or open lawn area for civic gathering, entertainment, flexible events, and local destination; a primary community-wide amenity, focal point, and attractor intended to extend the public realm, draw in outside guests, support local retail or commercial development within the community, and be an overall central space for community interaction and events.

Size: Community Plazas to be at least 50 feet x 50 feet, Commons to be at least 5,000 square feet with one side at least 50 feet. Typically, the largest and most significant open space in a development and top of the open space hierarchy.

Location & Application: located at ground level, adjacent to or visible from a primary roadway and in a centralized development location or at the confluence of major circulation routes. Spaces should be highly visible and the centerpiece of the development.

Development Frontage: ground floor retail or commercial uses.

Access & Usage: publicly accessible. Permitted to provide barrier controls to limit public access to the space after business hours or at night consistent with city park hours of operation. Pedestrian thoroughfare and connectivity required on at least one side of the space to key circulation routes and destinations within and outside the development.

Landscape: include a minimum of 25% planted areas and a minimum of one 24-inch box tree for every 500 square feet of common open space for the first 2,500 square feet, then one 24-inch box tree for every 1,000 square feet of common open space thereafter.

Programming: generally more passive uses, intended to support community gathering, flexible events, shopping, entertainment, and other community-wide destination uses that don't include recreation or other active programming typically reserved for parks and recreational amenity areas. Refer to Section 9.8 for shortlist of potential programming options to consider when planning the space.

Additional Requirements: n/a.



Appendix B: Common Open Space Types

B.2 Neighborhood Parks and and Recreational Amenity Areas

Accessible local parks and recreation spaces offering nearby residents places for activity, exercise, play, and community connection, featuring amenities like outdoor seating and shade, green spaces, recreational facilities, barbecues/picnic, and more. They serve as essential neighborhood hubs for physical activity, social interaction, and easy access to nature, fostering healthier, more resilient communities. Designed for people living in the surrounding residential developments, usually within a quarter-mile radius or less.

Size: spaces can vary significantly in size / shape but shall have a minimum area of 1,000 square feet and a minimum dimension of 25 feet in each direction.

Location & Application: located at ground level, to be visible from an adjacent roadway or primary circulation route. Spaces intended to be accessible for all residents within a 1320' radius (1/4 mile, 5-minute walk) and can be a single space or a distributed series of spaces as required to serve the full development.

Development Frontage: primarily residential uses, can also include small or limited ground floor retail / commercial uses required to support park / amenity area programming, eg. corner shops, small cafes, vending kiosks, etc.

Access & Usage: publicly or privately accessible. Permitted to provide barrier controls to limit public access to the space after business hours or at night consistent with city park hours of operation. Public street with sidewalk, or pedestrian walkway of at least 15' width required on at least one side of the space connecting to key circulation routes and destinations within and outside the development.

Landscape: include a minimum of 50% planted areas and a minimum of one 24-inch box tree for every 500 square feet of common open space **for the first 2,500 square feet of common open space thereafter.** Exceptions may be given for small spaces dedicated to dense, more active programming that provide significant community benefit.

Programming: primarily active uses with focus on serving resident recreation, activity, and social needs including sports courts, kids play, community swimming pools, picnic and barbecues, etc. Refer to 5.8 for shortlist of potential programming options to consider when planning the space.

Additional Requirements: n/a.



B.3 Courtyards

An open, unroofed outdoor area, often paved, that is partially or completely enclosed by the walls of adjacent buildings, providing a semi-private, secluded outdoor space for light, air, relaxation, or gathering.

Size: spaces shall have a minimum area of 600 square feet and a minimum dimension of at least 20' wide, with secondary dimensions relative to the height of the abutting building(s) wall. Secondary dimensions shall be: up to 2.5 stories = 30' wide, 3 to 5 stories = at least 40' wide, 6 to 8 stories = at least 1/2 the height of the tallest wall.

Location & Application: located at ground level, buildings shall define at least two edges of the courtyard space. Courtyards encouraged to be accessible from a primary roadway when requiring public access, otherwise discretionary for private access but should comply with and support all frontage and building break requirements (e.g. visibility from public street required when using paseo and Courtyard to comply with building break standard 1.3).

Development Frontage: primarily residential uses, can also include small or limited ground floor retail / commercial uses required to support Courtyard programming, eg. corner shops, small cafes, vending kiosks, etc.

Access & Usage: publicly or privately accessible when in residential frontage conditions, publicly accessible when in retail or commercial frontage conditions. Permitted to provide barrier controls to limit public access to the space after business hours or at night consistent with city park hours of operation. No specific pedestrian thoroughfare requirements for this type of space but linking Courtyard spaces to other open spaces, including other Courtyards, is always encouraged.

Landscape: include a minimum of 25% planted areas and a minimum of one 24-inch box tree for every 500 square feet of common open space **for the first 2,500 square feet, then one 24-inch box tree for every 1,000 square feet of common open space thereafter.**

Programming: more passive uses focused on fulfilling resident needs for quiet, intimate spaces serving as tranquil areas for relaxation, connection to nature, socializing, dining, or gardening, while also improving a building's microclimate and aesthetics by integrating indoor/outdoor living. The physical spaces may vary significantly from hardscape type courtyard plazas to more heavily planted courtyard gardens. Refer to 5.8 for shortlist of potential programming options to consider when planning the space.

Additional Requirements: n/a.



Appendix B: Common Open Space Types

B.4 Forecourts

Open, paved area directly in front of a multi-family residential or mixed-use building, serving as an entrance, gathering space, waiting / seating area, and pre-entrance space to the lobby, creating a grand approach and welcoming entry for visitors to the building. It functions as a front courtyard or terrace, designed to enhance the building's appeal and manage pedestrian flow into and out of the building.

Size: spaces shall have a minimum area of 200 square feet and a minimum dimension of 10 feet in each direction.

Location & Application: located on the ground floor in front of or adjacent to a residential building entrance/lobby, a retail entrance, or an office lobby.

Development Frontage: residential, retail, or commercial uses.

Access & Usage: publicly accessible. Forecourts to provide pedestrian walkway connections to public realm facing sidewalks / walkways and any vehicular drop-off zones.

Landscape: include a minimum of 25% planted areas and a minimum of one 24-inch box tree for every 500 square feet of common open space for the first 2,500 square feet, then one 24-inch box tree for every 1,000 square feet of common open space thereafter.

Programming: primarily passive uses, including fixed and loose seating, shaded outdoor waiting areas, and transition spaces into and out of the building. Refer to 5.8 for shortlist of potential programming options to consider when planning the space.

Additional Requirements: n/a.



B.5 Pocket Parks

Small public green space, tucked into residential community areas offering residents a nearby spot for quite relaxation, play, socializing, or enjoying nature, where there may not otherwise be any park areas or space to fit them. Pocket Parks can be various sizes and shapes and can be used to transform otherwise underutilized areas into valuable community assets with seating, greening, and pathways.

Size: spaces shall have a minimum area of 360 square feet and a minimum dimension of 15 feet in each direction.

Location & Application: located at ground level, these smaller spaces are encouraged to be distributed throughout the development to provide easily accessible open space opportunities to residents without needing a sizable footprint for a full park. Spaces may also be located in any leftover or undevelopable site areas to serve residential units that may not have or are distant from any other common open spaces. Ideally some measure of smaller open spaces shall be available within a 3 min walk of all residential units, or roughly 800 feet.

Development Frontage: primarily residential uses, offering open space opportunities where they are most needed and available.

Access & Usage: publicly accessible when in retail or commercial frontage conditions; publicly or privately accessible when in residential frontage conditions. Permitted to provide barrier controls to limit public access to the space after business hours or at night consistent with city park hours of operation. Encouraged to link pocket parks to other open spaces areas through secondary connection systems.

Landscape: include a minimum of 25% planted areas and a minimum of one 24-inch box tree for every 500 square feet of common open space for the first 2,500 square feet, then one 24-inch box tree for every 1,000 square feet of common open space thereafter.

Programming: a broad range of active and passive uses to be allowed in these small, compact spaces for a more flexible distribution of communal open space needs within the development. From simple, contemplative green spaces to more targeted recreation amenities including exercise and kids' play areas, overall programming to take a comprehensive, community-wide view and utilize available space accordingly. Refer to 5.8 for shortlist of potential programming options to consider when planning the space.

Additional Requirements: n/a.



Appendix B: Common Open Space Types

B.6 Paseos

Publicly accessible, pedestrian-only pathways used to connect adjacent open spaces and create a larger district-wide network of connected and walkable spaces. Paseos can also be unique linear places programmed with elements and activities to also activate the linear stretches between larger open spaces. Paseos can include a hierarchy of widths and scales to create a rich network of major to minor connectors.

Size: minimum 15' wide, or wider as required for fire/ life safety access.

Location & Application: located at ground level, new connections intended to break up large blocks of development and create more pedestrian porosity, walkability, and programming opportunities, required to connect to public street frontage or common open space at one end minimum, preferably both ends. Any programming applied within the corridor must maintain a walkable clearance of at least 6' wide.

Development Frontage: residential, retail, or commercial uses.

Access & Usage: publicly accessible. Permitted to provide barrier controls to limit public access to the space after business hours or at night consistent with city park hours of operation.

Landscape: include a minimum of 15% planted areas, no tree planting requirements.

Programming: primarily passive uses, including furniture, building spill-out areas, outdoor dining, flexible vending, seasonal decoration, moveable planters, and other non-permanent or semi-permanent uses that can be relocated as required. Refer to 5.8 for shortlist of potential programming options to consider when planning the space.

Additional Requirements: n/a.



B.7 Passthroughs

Privately owned and maintained passageways or hallways through interior building spaces that are opened to the public and connect key adjacent open spaces and interior building spaces. Pass-through spaces are often activated to further extend the network of open spaces while also blending connectivity.

Size: minimum 10' wide or complying with interior building requirements, whichever is wider.

Location & Application: located at ground level, new connections intended to break up large blocks of development and create more pedestrian porosity, walkability, and programming opportunities through interior building spaces creating public access, required to connect to public street frontage or common open space at one end minimum, preferably both ends. Any usable programming within the corridor must maintain a walkable clearance of at least 6' wide.

Development Frontage: residential, retail, or commercial uses.

Access & Usage: publicly accessible. Permitted to provide barrier controls to limit public access to the space after business hours or at night consistent with city park hours of operation.

Landscape: no planted area or tree planting requirements.

Programming: primarily passive uses, including furniture, building spill-out areas, outdoor dining, flexible vending, seasonal decoration, moveable planters, and other non-permanent or semi-permanent uses that can be relocated as required.

Additional Requirements: n/a



Appendix B: Common Open Space Types

B.8 Alley Walkways / Green Alleys

Existing vehicular corridors for building access and back-of-house services repurposed to become more activated, pedestrian friendly spaces, creating another layer of connection, exploration and discovery. Art, seating, lighting, greening and reduction of impermeable paving all help soften and create more comfortable pedestrian spaces. Scheduled daily closure of the alley to vehicular traffic can prioritize pedestrian walkability but still maintain access for local deliveries and services during off hour times.

Size: typically existing, to comply with local roadway / vehicular access standards for new developments or minimum 20' wide for fire life safety access, whichever is greater.

Location & Application: utilize existing alleyways to create more pedestrian porosity, walkability, and programming opportunities, may only be counted toward open space requirements in block-scale or commercial zones, and spaces must exclude regular parking access and have time-limited vehicular access for service/back-of-house access; corridor spaces must be for primarily pedestrian use to count toward open space requirements. Any programming applied within the corridor must maintain a drivable clearance of at least 20' wide.

Development Frontage: residential, retail, or commercial back-of-house frontage.

Access & Usage: publicly accessible. Permitted to provide barrier controls to limit public access to the space after business hours or at night consistent with city park hours of operation. Also acceptable to limit vehicular access to designed times of the day / night to prioritize pedestrian circulation during peak hours.

Landscape: planting areas encouraged but not required, no tree planting requirements.

Programming: primarily passive uses, including furniture, building spill-out areas, outdoor dining, flexible vending, seasonal decoration, moveable planters, and other non-permanent or semi-permanent uses that can be relocated as required. Art and lighting encouraged to add expressive placemaking layers to the back-of-house spaces. Creating opportunities for landscape and greening is also encouraged to help soften spaces and promote other environmental benefits such as stormwater management, infiltration, filtering pollutants, and habitat creation.

Additional Requirements: use of permeable paving systems encouraged but not required. Asphalt paving prohibited. See parking access and service/back-of-house restrictions to being considered open space as noted above.

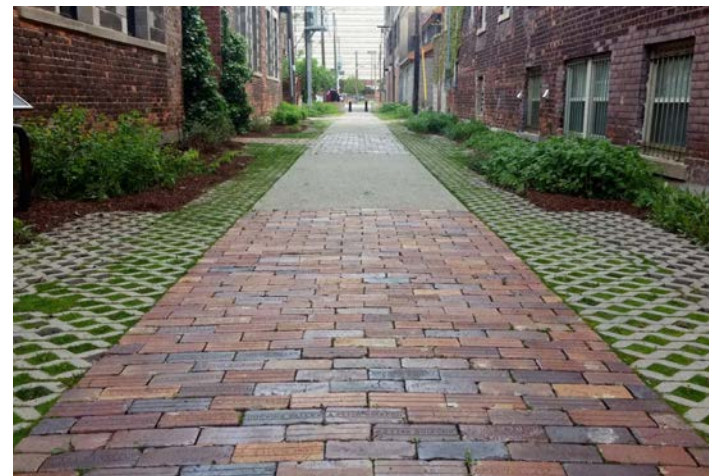

B.9 Shared Yards

An outdoor area associated with a grouping of homes or buildings, meant for the exclusive use of those occupants, kept separate from public or overall community access, often enclosed by fences/walls for seclusion, offering a personal outdoor retreat for relaxation or recreation away from public view. Spaces include back and side yards and are not for general community use, though legal privacy levels can depend on visibility from neighbors.

Size: at least 50% of lot dimension in one direction, and at least 25% of lot dimension, or 15', whichever is greater, in perpendicular direction.

Location & Application: located at ground level in front, back, or side yard areas surrounding and accessible from the residential unit(s).

Development Frontage: multi-family residential and individual residential units, frontage may also include residential supporting amenities such as recreation rooms, lounges, gyms, etc assuming there is egress to the yards from residential units at some points.

Access & Usage: privately accessible, shared between multiple residential units.

Landscape: include a minimum of 25% planted areas and a minimum of one 24-inch box tree.

Programming: passive residential uses such as outdoor dining, barbecuing, hosting and event spill-out, casual gathering, yard games, gardening, general recreation, and other uses appropriate for private-use communal spaces shared between multiple residents, light active uses such as communal swimming pools and spas are allowed and where space allows.

Additional Requirements: n/a.



Appendix B: Common Open Space Types

B.10 Terraces and Decks

A usable open air space on top of a building, shared among building residents, used for recreation, gathering, or relaxing, offering a pleasant space for outdoor activities and views with features like furniture, plants, and other amenities, distinct from a patio by being raised above the surrounding grade or built on an exterior building level, offering an elevated vantage point and expansive views.

Size: spaces shall have a minimum area of 360 square feet and a minimum dimension of 15 feet in each direction.

Location & Application: located on upper building floors (usually the second floor or higher) on flattened external areas, interfacing and accessible from adjacent residential unit(s). Spaces may also be located on dedicated ground floor areas that are elevated as communal outdoor spaces, or on garage podiums. Decks shall be set back a minimum of 6' from any building edge overlooking a lower-density residential development.

Development Frontage: multi-family residential units, or residential supporting amenities such as recreation rooms, lounges, gyms, etc assuming there is egress to the terrace and deck areas from residential units at some points. Terraces and Decks may front on patios when over podium conditions.

Access & Usage: privately accessible, shared between multiple residential units.

Landscape: include a minimum of 15% planted areas, tree planting encouraged but not required.

Programming: passive residential uses such as outdoor dining, barbecuing, hosting and event spill-out, casual gathering, deck games, gardening, general recreation, and other uses appropriate for private-use communal spaces shared between multiple residents, light active uses such as communal swimming pools and spas are allowed and where space allows.

Additional Requirements: pergola, trellis, and/or permanent shade device are allowed, the covering height for any structures not to exceed 12' in height. Any shade devices that exceed the height limit of the district shall be stepped back at least 10' from any street-facing façade. Solid roofing is not allowed over the deck space, except for roof projections from the adjacent building.



B.11 Rooftop Decks:

A paved, usable outdoor space located on a building's rooftop, shared among building residents, providing areas for relaxation, dining, or entertainment. A rooftop deck is distinct from terraces and decks in that it is found on the building's topmost roof level whereas the others are typically found on lower building levels, on podiums, or at ground level. A popular amenity for residential developments, turning underutilized rooftop areas into functional outdoor spaces. Rooftop spaces may also contain specialized on-structure planters to add greening, shade, and softscape amenities.

Size: minimum same as Terraces and Decks, maximum of total roof area for projects in house scale zones, 75% of total roof area for projects in block-scale zones. Ability to count toward minimum open space requirements limited by standard 5.9.

Location & Application: top of building rooftops. Decks shall be set back a minimum of 6' from any building edge overlooking a lower-density residential development.

Development Frontage: does not typically include residential fronting units at the rooftop level but may include residential amenity uses extending up to the rooftop level, eg. recreation rooms, lounges, gyms, etc.

Access & Usage: privately accessible, shared between multiple residential units.

Landscape: include a minimum of 15% planted areas, tree planting encouraged but not required.

Programming: passive residential uses such as outdoor dining, barbecuing, hosting and event spill-out, casual gathering, deck games, gardening, general recreation, and other uses appropriate for private-use communal spaces shared between multiple residents, light active uses such as communal swimming pools and spas are allowed and where space allows.

Additional Requirements: pergola, trellis, and/or permanent shade device are allowed, the covering height for any structures not to exceed 12' in height. Any shade devices that exceed the height limit of the district shall be stepped back at least 10' from any street-facing façade. Solid roofing is not allowed over the deck space.



Appendix B: Common Open Space Types

B.12 Green Roofs

A building roof partially or fully covered with vegetation and a growing medium (like engineered soil), creating a natural, functional ecosystem on a structure. These multi-layered on-structure systems help manage stormwater, reduce heat, improve air quality, and provide habitats, acting as an extension of the building's landscape to offer environmental and economic benefits like energy savings and longer roof life. Differentiated from a rooftop deck, terrace, or podium deck by not directly serving or meant to be used by residents, often with a passive or visual only function related to resident engagement.

Size: full rooftop spaces are permitted for use minus edge setbacks requirements. Any rooftop areas proposed to be accessible for residents must not encroach into the minimum planting area requirements for this space. Ability to count toward minimum open space requirements limited by standard 5.9; additionally, green roofs may fulfill only up to 50% of a project's common open space requirement.

Location & Application: top of building rooftops. Decks shall be set back a minimum of 6' from any building edge overlooking a lower-density residential development.

Development Frontage: typically there would be no building uses fronting this space except for access to the rooftop deck.

Access & Usage: typically not accessible to residents but small areas can be made privately accessible shared between multiple residential units.

Landscape: a minimum of 75% of deck area must be planted with groundcover / shrubs. No specific tree planting requirements, but tree planting encouraged where soil depth allows.

Programming: mostly inaccessible for use, limited areas that are accessible to have similar passive uses to terraces and decks.

Additional Requirements: n/a.



Appendix C: Private Open Space Types

C.1 Balconies (covered or uncovered)

An elevated, private outdoor space that extends the living area, offers fresh air, natural light, and views, while also adding aesthetic appeal, functioning as a mini-garden, relaxation nook, or dining spot. It serves as an extension of the home, bringing the outdoors in without requiring a yard, making it ideal for urban living conditions.

Size: at least 5' in any direction, to accommodate seating and a table.

Location & Application: located on upper floors (usually the second floor or higher), directly attached to the outside of the residential unit(s), and can be architecturally covered or uncovered.

Development Frontage: multi-family residential and individual residential units.

Access & Usage: privately accessible, for a single residential unit.

Landscape: allowed to be fully hardscape paved, no planted area or tree planting requirements.

Programming: intended to extend the living space for limited passive uses like outdoor dining, relaxation, views outward, etc.

Additional Requirements: encouraged for guardrail on longest side to be visually transparent (i.e. no solid walls)



C.2 Patios

A paved, ground-level or podium-level outdoor space that is connected to a residential unit, or in close proximity, for exclusive use of that residence. Patios can be accompanied by surrounding yards as part of the larger private outdoor open space but can also be limited to just the immediate patio space for more urban living conditions.

Size: at least 6' deep, to accommodate outdoor furniture, and at least 15' wide.

Location & Application: located at the ground floor or podium-level in fully residential conditions, or podium-level only in mixed-use development conditions where retail/commercial uses are occupying the ground floor. Patios are typically connected directly to the associated residential unit and can also be included within a larger surrounding yard on the ground floor.

Development Frontage: multi-family residential and individual residential units.

Access & Usage: privately accessible, for a single residential unit.

Landscape: allowed to be fully hardscape paved, no planted area or tree planting requirements.

Programming: intended to extend the living space outside for limited passive uses like outdoor dining, barbeque, relaxation, casual gathering, gardening, etc.

Additional Requirements: n/a.



Appendix C: Private Open Space Types

C.3 Private Rooftop Decks

A private, usable outdoor space built on a building's rooftop areas, providing areas for relaxation, dining, or entertainment. A popular amenity for residential developments, turning underutilized roof areas into functional outdoor spaces for residents. Rooftop spaces may also contain specialized on-structure planters to add greening and softscape areas.

Size: at least 10' in any direction, to allow the deck to function as an outdoor room.

Location & Application: located on upper building floors (usually the second floor or higher) on flattened external areas, interfacing and accessible from an adjacent residential unit.

Development Frontage: multi-family residential and individual residential units.

Access & Usage: privately accessible, for a single residential unit.

Landscape: allowed to be fully hardscape paved, no planted area or tree planting requirements.

Programming: intended to extend the living space for limited passive uses like outdoor dining, barbeque, relaxation, views outward, etc.

Additional Requirements: Any shade devices that exceed the height limit of the district shall be stepped back at least 10' from any street-facing façade.



C.4 Private Yards

An outdoor area directly associated with a home or building, meant for the exclusive use of its occupants, kept separate from public access, often enclosed by fences/walls for seclusion, offering a personal outdoor retreat for relaxation or recreation away from public view. Spaces include front, back, or side yards and are for private use.

Size: at least 50% of lot dimension in one direction, and at least 25% of lot dimension, or 15', whichever is greater, in perpendicular direction.

Location & Application: located at ground level in back or side yard areas surrounding and accessible from a residential unit.

Development Frontage: individual residential unit.

Access & Usage: privately accessible, for a single residential unit.

Landscape: include a minimum of 25% planted areas and a minimum of one 24-inch box tree.

Programming: intended to extend the living space outside for limited passive uses like outdoor dining, barbeque, relaxation, casual gathering, gardening, etc. Yard areas may include a patio with the overall yard space.

Additional Requirements: n/a.



Appendix C: Private Open Space Types

C.5 Porches

A porch is a larger, often roofed structure at the front door, extending along the house, designed for outdoor living with furniture, railings, and columns, making it a functional extension of the home. Porches are for leisure and architectural grandeur.

Size: Between 6' and 10' deep and at least 10' wide, in conformity with standards in A.4.

Location & Application: Along the street frontage, within parameters given in A.4.

Development Frontage: Individual residential unit within a single-family or multifamily building.

Access & Usage: privately accessible, for a single residential unit.

Landscape: No planted area or tree requirements.

Programming: intended to extend the living space outside and provide "eyes on the street". Limited passive uses such as relaxation, casual gatherings and views to the street.

Additional Requirements: n/a.



Appendix D: Definitions

DEFINITIONS

Alley: A narrow service way, either public or private, that provides a permanently reserved but secondary means of public access. Alleys typically are located along rear property lines.

Arcade: Also known as Colonnades. A linear sequence of arches supported on piers or columns which provide a covered walkway.

Architectural Features: Towers, gables, spires, chimneys, and other such architectural elements which are not part of the structure of the building.



Architectural Feature Example: Towers, gables, and chimneys pictured.

Architectural Projection: An element that articulates the building elevations, such as architectural pop-outs, pot shelves, balconies, bay windows, eaves, enhanced window sills, shutter details, window trim, chimneys, and similar architectural features, but does not include patio covers, porches, trellises, or other accessory structures.



Architectural Projection Example: Pop-outs, balconies, window sills, shutter details, and chimneys pictured.

Base Course: The lowest horizontal band or layer of material along the bottom portion of a building façade. It functions as a visually distinct base that grounds the building and differentiates the ground level from the upper wall planes. A base course often uses heavier, more durable, or more textured materials—such as stone, brick, concrete, or masonry—to convey structural stability and withstand physical wear.



Base Course (bottom), Belt Course (middle), Cornice (top) Example

Bedroom: Any habitable room other than a bathroom, kitchen, dining room, living room or family room.

Belt Course: Also known as a stringcourse or band course. A continuous, horizontal band of masonry, stone, plaster, or other material that runs across a building façade. It typically projects slightly from the wall plane or is distinguished through material, color, or texture. Its purpose is to visually divide the façade into horizontal layers, helping to articulate massing and break down the building’s scale.

Building Break In Mass: A deliberate architectural interruption in the overall bulk, scale, or continuous form of a building façade or volume.

Building Face: The outside elevation of the occupiable portion of the building.

Building Façade: The exterior face or elevation of a building, typically referring to one of its principal sides.

Common Area: The area within the development that is not designated as a residential dwelling unit, which is owned in common by property owner(s) in the development, and which is available for common use or enjoyment by all property owners in the development and their invitees. Examples include: common parking facilities, private streets, recreational areas, landscaped areas, open space areas and natural areas.

Cornice: A exterior trim located at the top of a building façade or wall, designed to visually “cap,” finish, or crown the structure. It typically extends outward from the wall plane to create a strong shadow line and provide a clear termination to the façade.

Daylit Basement: A walk-out basement, usually situated on a slope, where part of the floor is above ground. Typically with a doorway or window opening to the outside.

Driveway: A private roadway or access way providing vehicular access to a parking space, parking lot, garage, dwelling, or other structure.

Entablature: A superstructure which lies horizontal upon pilasters or columns, and is composed of an architrave, frieze, and cornice.



Entablature Example

Fence: A solid or open barrier other than a wall above ground intended to enclose or mark a boundary made of materials such as wood, metal, other composite materials.

Flashing: Sheet metal or other material used to cover open joints of exterior construction on a roof, such as roof valley joints or roof parapet joints, to ensure they are waterproof.

Foot-candle: A unit of illuminance or light intensity. The name conveys the illuminance cast on a surface by a one-candela source one foot away. Alternatively, it can be defined as the illuminance on a one-square foot surface of which there is a uniformly distributed flux of one lumen.

Gable End: When the ridge line of a gable-roofed house is perpendicular to the street, the roof is said to be a “gable-end roof.” This refers to both the gable and the wall below it.

Gable Roof: A roof with two (2) slopes—front and rear—joining at a single ridge line parallel to the entrance facade.

Appendix D: Definitions

Ground Floor Expression Line: A horizontal molding, projection, or other boundary articulating one portion of a façade from the portion above.



Ground Floor Expression Line Example

Hardscape: Any impervious paved surface including concrete or asphalt.

Hemmed: As it relates to metal wall panels, the edge of a single piece of metal that is folded over onto itself to create a smooth, reinforced, and safe finish.

Hip Roof: A roof with four sloped sides. The sides meet at a ridge at the center of the roof. Two (2) of the sides are trapezoidal in shape, while the remaining two (2) sides are triangular, and thus meet the ridge at its end-points.

Louvers: A series of slanted panels that control the sound, light, and airflow in a building, which typically covers plenums and other ventilation openings. Louvers typically block rain, debris, and direct sun.

Massing: A unified composition of two-dimensional shapes or three-dimensional volumes, especially one that has or gives the impression of weight, density, and bulk.

Open Space: Any parcel or area of land or water set aside, dedicated, designated, or reserved for public or private use or enjoyment.

Pane: One of the divisions of a window or door consisting of a single unit of glass set in a frame.

Parapet: A low wall, located at the top of any sudden drop in elevation, such as at the top of a building's facade.

Parkway: A vehicular passageway that provides access and circulation from a street access point into and through a parking lot to parking aisles and between parking areas.

Paseo: A public place or path designed for walking; usually tree-lined, such as a promenade or avenue.

Porch: A covered pedestrian entrance to a building, open on all three sides, which is located on the first floor level.

Porte-cochere: A vehicular passageway leading through a building or screen wall into an interior courtyard; or a porch roof projecting over a driveway at the entrance to a building and sheltering those getting in or out of vehicles.

Primary Entry: The main entrance to any building, or space within a building which is not internally linked to other spaces within a building, such as an individual residential unit or retail storefront. Secondary building entries and exits which are for emergency egress purposes only or linkages between spaces in a building do not qualify as primary entrances.

Primary Material: A material used to clad the exterior of a building as distinct from accent materials used in architectural details or features.

Primary Street: Among all streets bounding a property, the street with the highest roadway classification as defined in the City's General Plan. In the case that multiple streets bounding a property have the same roadway classification, the primary street shall be the addressed street, or as determined by the **Planning and Community Preservation Director**.

Private Open Space: Any space on a lot not enclosed in a building that is designed for leisure use. "Private open space" may include yards, courtyards, balconies, decks, and patios, but shall not include driveways, aisles, parking areas, side yard less than five feet wide, or any portion of the required front yard setback.



Private Open Space and Reveal Example: Courts, decks, patios, and reveal pictured.

Private Realm: Spaces located on private property that are not accessible to the general public.

Public Realm: Spaces that, whether located on private or public property, are accessible to the general public.

Reveal: A narrow, intentional recess, groove, or setback in a wall plane that creates a visible line of separation or shadow. Reveals are used to articulate a façade, break up large surfaces, emphasize joints, or provide visual depth without altering the overall mass of a building.

Riding and hiking trails: A trail or way designed for and used by equestrians, pedestrians and cyclists using non-motorized bicycles.

Right-of-way: A corridor, either public or private, on which a right of passage has been recorded.

Roof Deck: Common or private open space on the uppermost roof-level of a building.

Setback: The distance from a defined point or line governing the placement of buildings, structures, parking, or uses on a lot. A line established by this section to govern the placement of buildings with respect to streets, drives, buildings, sidewalks, or property lines. Interior setbacks are measured from the side or rear property lines. Street setbacks are measured from property lines.

Shared Parking: The shared use of off-street parking facilities by more than one type of land use. The same parking spaces are counted to satisfy the off-street parking requirements of more than one land use, e.g., use of the same parking facility to satisfy the off-street parking requirements of a church and an office building.

Side Street: Any street bounding a property which is not the Primary Street.

Stoop: A raised platform, approached by steps and sometimes having a roof, at the entrance of a dwelling unit.

Street: A public or private vehicular right-of-way, other than an alley or driveway, including both local streets and arterial highways.

Swimming Pool: An artificial body of water having a depth in excess of eighteen (18) inches, designed, constructed and used for swimming, dipping or immersion purposes by men, women, or children.

Tooling: As it relates to mortar joints, is the process of compressing and shaping the fresh (partially set) mortar with a metal tool to create a dense, weather-resistant finish and a specific appearance.

Transition Detail: A designed connection, junction, or interface condition where two different materials, surfaces, building elements, or façade systems meet, such as reveals, flashing, control joints, coping, sealant joints, or trim boards.

Appendix D: Definitions

Transparency: The percentage of the façade area on a particular floor that consists of transparent glass. For the ground floor, this percentage is calculated as the transparent glass façade area between two and ten feet above finished grade divided by the total façade area within this same vertical range. For upper floors, this percentage is calculated as the transparent glass façade area divided by the total façade area between the floor level and the floor level of the next floor above.

To be transparent, window and door glazing shall meet the following requirements:

	Visible Light Transmittance	External Reflectance
Ground Floor	Minimum 60%	Maximum 20%
Upper Floors	Minimum 30%	Maximum 40%

Usable Area: A relatively flat area having a slope of less than five (5) percent in any direction within the required setbacks.

Use: The purpose for which land or building is occupied, arranged, designed or intended, or for which either land or building is or may be occupied or maintained.

Walls: A barrier intended to mark a boundary that presents a continuous surface except where pierced with gates, doorways or decorative masonry. A wall is usually constructed of concrete block, brick, concrete, stucco, or a combination thereof.

Wall Plane: A continuous, flat surface of a wall, uninterrupted by major changes in direction, projection, or recess. It represents one “face” or “segment” of a building’s exterior or interior wall system and is typically defined by consistent alignment, material, and structural direction.

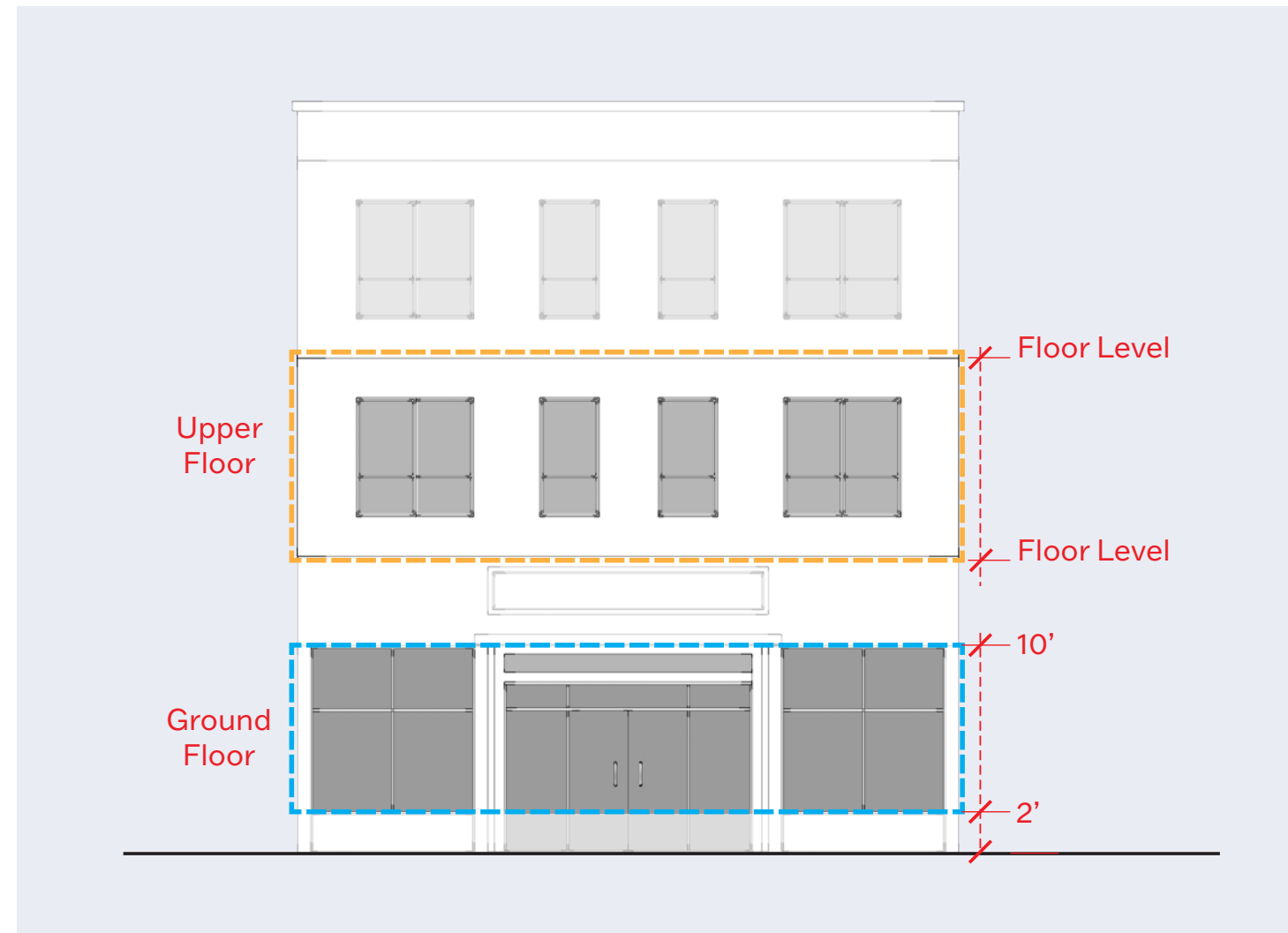

Transparency Measurement

Appendix E: SGVCOG Regional Objective Design Standards Research Memorandum

Memo of ODS | The Arroyo Group
SGV COG Objective Design Standards
25 September 2025



Regional Objective Design Standards Research Memorandum

To:

Brielle Salazar, Regional Housing Trust Manager
Rosalie Lansing, Management Aide
Jois Talla, Management Aide
(SGVCOG)

From:

Philip Burns, Principal and Project Manager
(The Arroyo Group)

CC:

Clare Lin, Planning Manager
Joshua Wolf, Senior Planner
Katelyn Huang, Assistant Planner
(City of Sierra Madre)

Maia McCurley, Principal Planner
Megan Wu, Associate Planner
(City of Alhambra)

Craig Hensley, Community Development Director
Jason Golding, Planning Manager
(City of Duarte)

This memorandum is submitted in fulfillment of Task 2.1 (Research) of our Scope of Work for Regional Objective Design Standards in the San Gabriel Valley Council of Governments. Background research was undertaken for three participating cities: Duarte, Alhambra, and Sierra Madre. The memorandum is based around three areas of research:

1. Existing regulatory context, design standards and experience implementing design standards in each city
2. Best practices in objective design standards from other jurisdictions and regions in California
3. Fieldwork into the built context and character of the major growth areas in each of the three participating cities
4. Identification of existing projects in the San Gabriel Valley which embody the application of potential design standards

Participating Cities Design Standards

Exhibit A describes existing design standards in each of the three participating cities. The table is organized by topic, helping us compare and contrast these standards. Relevant development standards are also included.

Duarte has the largest collection of design guidelines and standards currently on its books. The architectural and design standards in its Municipal Code which apply to all residential zones cover a wide variety of topics. This is also true of its Duarte Station and Town Center Specific Plans, which were both prepared by the City and together comprise the entirety of areas zoned for high-density (>30 du/ac) residential and mixed-use development. In all three documents, design topics are addressed with a mix of objective standards and subjective guidelines. While the subjective guidelines are not enforceable for denial of a project, or for evaluation through a ministerial project approval process, they do provide a good sense of the intent for each of these areas, and they will form a solid starting-off point for the writing of objective design standards.

Memo of ODS | The Arroyo Group
SGV COG Objective Design Standards
12 September 2025

Based on design review comment letters submitted by the City, Duarte has a mix of large-scale/institutional and mid-sized projects, with accompanying differences in the level of sophistication in design. Key issues cited in the comment letters include materiality and cohesion between colors/materials, lack of articulation/human-scaled design, appropriate use of architectural styles. The City is looking for more prescriptive and stringent standards which can address these issues.

Since the creation of the Design Review Board in 1989, Alhambra has remained committed to promoting architectural and urban design excellence through a structured and thoughtful design review process. In support of this ongoing mission, the City has recently conducted training sessions for both Board members and City staff. These sessions aim to enhance the design review process by providing guidance on assessing the completeness of architectural drawings, recognizing prevalent architectural styles, and understanding key architectural terminology. Through its continued experience, the City has recognized that the design review process serves as a vital tool for regulating aspects of design not typically addressed through other review procedures. These include considerations of the street character, neighborhood compatibility, and the cohesion of the built environment. The Design Review Board places particular importance on several key design principles: fostering human-scale street connections, ensuring building massing and scale are respectful of adjacent structures, maintaining internal consistency within architectural styles, and selecting materials and details that contribute to authenticity, durability, and contextual appropriateness. However, there are inherent challenges with this type of review: subjective reviews which can be inconsistent based on the members of the Board or the circumstances of the moment. Now the City is making the adjustment to objective design standards, first with a starter list included in its recent comprehensive zoning code update, and now with an effort concurrent to this one to develop a full set of design standards.

Sierra Madre possesses a list of mostly discretionary design guidelines for its commercial and multi-family zones. The City's unique village-like character is reinforced, however, by strict height limits and standards relating to second- and third-story articulation. The City also implemented development standards related to open space, setbacks, stepbacks and other massing and site planning considerations for its recent high density multifamily zones (20-30 du/ac) and its Religious Housing Overlay. The City has had few recent multifamily applications and little experience with design review.

Comparison Objective Design Standards

Exhibit B presents an evaluation of other objective design standards used at the municipal and regional level. While there is wide variety in the format of these documents, some of the key best practices that we gleaned from the analysis are to:

- Provide guidelines or statements of intent along with objective standards
- Provide options of different strategies to meet the intent of standards
- Use clear diagrams along with photographic examples to represent standards
- Provide definitions for architectural terms
- Take into account the context of unique cities and districts to ensure that standards are apt

The analysis contained here will help inform the RODS outline to be prepared in the next phase of the process.

Fieldwork

We conducted fieldwork to document the built character of projects and districts to fulfill two different purposes. Locations of conducted fieldwork are presented in Exhibit C.

In Exhibit D, we surveyed districts where growth and development are most expected, to determine prevailing character features that may want to be reflected in objective design standards. Across the surveyed districts, building stock generally ranges from the 1920s through the 1980s, with Alhambra's Main Street and Garfield areas showing the oldest and most historically significant structures (1920s-1950s, many with façade renovations), while Duarte's Huntington Drive and Sierra Madre's Esperanza/Suffolk corridors primarily feature mid-century commercial forms (1950s-1980s) with limited upkeep. Overall conditions are mixed but lean toward fair to good, with visible signs of aging such as roof wear, dated façades, and minimal modernization, though repainting and signage updates are common. Sierra Madre is

Appendix E: SGVCOG Regional Objective Design Standards Research Memorandum

Memo of ODS | The Arroyo Group
 SGV COG Objective Design Standards
 12 September 2025

also notable for its modest character with possible historic elements.

Exhibit E contains a field evaluation of individual projects. The individual projects in Alhambra, Duarte, and Sierra Madre reveal a mix of building types reflecting different eras and design intentions. Alhambra's McLean and Stoneman sites (102, 116, and 630 Stoneman) are early-2000s multifamily developments, generally well-maintained with consistent façades, landscaping, and no historic significance, while Benito Avenue represents a newer 2010s residential project with a more contemporary form. By comparison, the Solana Duarte Station, Huntington Apartments, and Olivia projects represent larger-scale, transit-oriented multifamily complexes, emphasizing modern amenities and height. Sierra Madre's Esperanza Avenue project is smaller in scale, rooted in mid-century residential fabric with modest upgrades. Together, these typologies span from suburban-style multifamily housing to urban mixed-use infill and larger transit-oriented developments, underscoring how different forms of reinvestment address local context, density goals, and market era.

As a part of this review of individual projects, we surveyed the cluster of recent (2000-present) mixed-use projects in and around the Central Business District of Alhambra. These projects give us a window into what aspects of design have been more and less successful, and how to guide future design standards for high-density mixed-use urban infill in the San Gabriel Valley. The West Main District features a collection of mixed-use developments constructed over the past 25 years, with the notable exception of a historic Art Deco building dating back to 1926. Collectively, these developments serve as a focal point that attracts visitors to the surrounding public spaces. The buildings typically exhibit a substantial base massing, where commercial activities are concentrated, while residential units are elevated on a podium level set back from the primary thoroughfares which creates a more private and secluded residential environment. Architectural elements such as arched openings and cylindrical facades are commonly used to emphasize primary entry points. The buildings also demonstrate a consistent design language, often characterized by neutral tones on the main façades, complemented by vibrant accent colors on elements such as railings and shading structures. The pedestrian environment is overall harsh and dull with a lack of softscape or landscaping at street level and limited transparency to the indoor activities or program that adds to the semi-public experience. In conclusion, this cluster of mixed-use buildings are modest and simple in their design and building form, yet still offers a balance between residential, commercial and regional spaces within a single location.

Identification of Other Projects

We also identified other projects in the San Gabriel Valley which present good examples of the application of particular design guidelines and/or standards. The projects, shown in Exhibit F, include examples of:

- Mixed-use developments with stacked flats above a ground-floor retail and parking podium
- "Wrap" style residential and mixed-use developments with stacked flats surrounding a central parking garage
- Master-planned communities
- Townhome developments
- Side-by-side double duplexes
- Courtyard multifamily developments

These projects represent potential resources that we can use to illustrate potential design standards to the public and in the final document.

Exhibit A	Duarte	Alhambra	Sierra Madre
Site Planning and Access	<p>Duarte Station Specific Plan (Esperanza and Solana): Development that occurs in future phases shall identify and design building, open space, and circulation networks to seamlessly link with existing development. An example of this would be siting buildings and pathways to facilitate visual and physical connections from the southern edge of the Specific Plan area to the linear park and internal circulation associated with Phase I.</p> <p>Connectivity to Metro Station: There shall be at least two pedestrian connections from the Specific Plan area to the station platform adjacent to the fare gates, subject to California Public Utilities Commission (CPUC) and Metro approval.</p> <p>The connections shall be direct, unobstructed, and designed to meet all applicable accessible standards, per CPUC and Metro standards.</p> <p>The connections can be through public plazas, pedestrian paseos, or outdoor dining areas. A clear, unobstructed minimum travel path shall be accommodated.</p> <p>The pedestrian path should connect to sidewalks and other pedestrian paths within the Specific Plan area to provide a larger, integrated pedestrian circulation framework.</p> <p>The path of travel shall be well lighted to create a safe environment at all times.</p> <p>Development proposals shall include a multi-modal circulation analysis that addresses connectivity of pedestrian, bike, transit, and other circulation methods.</p> <p>Duarte Town Center Specific Plan: Uses should be oriented to facilitate proper transitions to surrounding buildings and adjacent uses.</p>	<p>West Main Corridor Master Plan: -Introduce small plazas and minor setbacks that modulate the building facade and extend the sidewalk along Main Street. -Ensure that street-oriented plazas are well-defined spaces accessible to the public.</p> <p>Alhambra MC 23.12.13b SCREENING: The standards of this section apply to all new development and additions that expand existing floor area by 10% or more.</p> <p>(B) Required screening (1) Roof-mounted equipment and duct systems. All roof-mounted equipment shall be screened according to the following standards: (a) Flat roof, partial or no parapet. Roof-mounted equipment or ducts located on a flat roof (partial or no parapet) shall be screened from view from any street, public right-of-way or adjacent property. The screening shall be solid, and shall match and complement the color scheme and architecture of the building. (b) Pitched roof. For roof-mounted equipment or ducts located on a pitched roof, the pitched roof shall be designed and constructed to accommodate roof-mounted equipment. A platform shall be constructed and recessed into the roof such that one side of the equipment shall be below the pitch of the roof. The remainder of the equipment and ducts which are above the roof pitch shall be screened from view from any street, public right-of-way or adjacent property. The screening shall be solid, and shall match and complement the color scheme and architecture of the building or roof. (c) Parapet roof. For roof-mounted equipment or ducts located on a parapet roof, the parapet roof shall be designed and constructed to accommodate roof-mounted equipment. Any portion of the equipment or ducts which are above the parapet shall be screened from view from any street, public right-of-way or adjacent property. The screening shall be solid, and shall match and complement the color scheme and architecture of the building. (2) Ground- or wall-mounted equipment. All exterior mechanical and electrical equipment shall be screened, flush mounted, or incorporated into the design of buildings so as not to be visible from public rights-of-way. Equipment to be screened includes, but is not limited to, air conditioners, heaters, pool equipment, utility meters, cable equipment, telephone entry boxes, backflow preventions, irrigation control valves, electrical transformers, pull boxes, and all ducting for air conditioning, heating, and blower systems. Screening materials shall be consistent with the exterior colors and materials of the building. Exceptions may be granted by the Director where screening is infeasible due to health and safety or utility requirements. (3) Common property lines. A screening wall shall be provided on the interior lot lines of any lot in a Commercial or Employment Zoning District that abuts a Residential Zoning District. (a) Timing. The screening wall shall be provided at the time of new construction or expansion of buildings, or changes from one use classification to another use classification. (b) Location. Screening walls shall follow the lot line of the lot to be screened unless the Director finds that screening in another location on the lot will substantially screen the subject building, facility, or activity. (c) Height. The screening wall shall be four feet in height within the required front setback of the subject lot and adjacent to the required front setback of the adjacent residential lot and six feet in height in other locations. (d) Materials. The screening wall shall be solid masonry. All wall faces within the front setback and the wall face facing the Residential Zoning District shall not be constructed from grey smooth block unless architecturally treated (i. e. sand finish stucco, veneer, etc.) and shall be architecturally compatible with the residential development. (C) Maintenance. Screening walls shall be maintained in good repair, including painting, if required, and shall be kept free of litter or advertising. Where hedges are used as screening, trimming or pruning shall be employed as necessary to maintain the required and the maximum allowed height.</p>	<p>R-3-13 Zone (Medium/High Density Residential Zone) and RHO (Religious Housing Overlay) Zone: Building siting should be related to nearby buildings as well as adjacent parcels. Be oriented to encourage use of outdoor areas and to be compatible with adjoining building orientation.</p>
Connectivity			
Screening	<p>Duarte Station Specific Plan (Esperanza and Solana): The street pattern throughout the Specific Plan area should maximize connectivity throughout the area for vehicles, bicyclists, and pedestrians.</p> <p>There shall be a distinct hierarchy of circulation including streets, pedestrian walks, and alleys. These should be arranged so that visitors and residents use these streets and pedestrian walks for their primary circulation. Alleys should not be used for primary circulation to the building or unit entries, and buildings should not orient to alleys or parking areas.</p> <p>Duarte Town Center Specific Plan: Mixed Use Standards: Residential and non-residential vehicular and pedestrian access shall be differentiated with paving material, color, landscape buffers, etc.</p> <p>City of Duarte Residential architectural and design standards (applies to all residential zones): Multifamily Standards: Interior pedestrian paths shall be provided to individual units and to link units to common open space areas and parking areas. See multi-family open space standards in Section 19.10.060 (R-3 and R-4 Zones: Additional Standards). Pedestrian and vehicular entrances shall be clearly identified and easily accessible to minimize pedestrian/vehicle conflict.</p>	<p>Chapter 23.13 Building and Site Design Standards: Pedestrian access. On-site pedestrian circulation and access shall be provided according to the following standards. (1) Internal connections. A system of pedestrian walkways shall connect all buildings on a site to each other, to on-site automobile and bicycle parking areas, and to any on-site open space areas or pedestrian amenities. (2) Circulation network. On-site walkways shall be connected to the public sidewalk and other planned or existing pedestrian routes. An on-site walkway shall connect the primary building entry or entries to a public sidewalk on each street frontage. (3) Pedestrian walkway design. Walkways shall be a minimum of four feet wide, shall be hard-surfaced, and paved with concrete, stone, tile, brick, or comparable material.</p> <p>Alhambra MC 23.13.020 BUILDING DESIGN REQUIREMENTS: Building entrances and orientation. All buildings located in the interior of a site shall have an entrance from a pedestrian walkway that is a minimum of four feet wide and connects to a public sidewalk.</p>	<p>R-3-13 Zone (Medium/High Density Residential Zone): Parking areas, refuse storage, mechanical equipment and the like shall be screened by some combination of walls, plantings or earthworks.</p>
Pedestrian Access	<p>Duarte Station Specific Plan (Esperanza and Solana): The street pattern throughout the Specific Plan area should maximize connectivity throughout the area for vehicles, bicyclists, and pedestrians.</p> <p>Duarte Town Center Specific Plan: Mixed Use Standards: Residential and non-residential vehicular and pedestrian access shall be differentiated with paving material, color, landscape buffers, etc.</p> <p>City of Duarte Residential architectural and design standards (applies to all residential zones): Multifamily Standards: Common parking areas shall be located on the site to minimize their visibility from public rights-of-way and to be easily accessible to all residents of the development. See parking design standards in Chapter 19.38 (Off-Street Parking Regulations and Design). Pedestrian and vehicular entrances shall be clearly identified and easily accessible to minimize pedestrian/vehicle conflict. The parking area shall be designed in a manner which links it to the building and street sidewalk system, as an extension of the pedestrian environment. This can be accomplished by using design features such as walkways with enhanced paving, trellis structures and/or landscaping treatment. Carports shall be architecturally compatible with the style of development.</p>		<p>Commercial Zone: Review of a proposed design shall be related to the surrounding existing development with greater emphasis placed upon compatibility with adjacent development related to e.Access</p>
Vehicle Access			<p>Commercial Zone: Review of a proposed design shall be related to the surrounding existing development with greater emphasis placed upon compatibility with adjacent development related to e.Access</p>

Appendix E: SGVCOG Regional Objective Design Standards Research Memorandum

Exhibit A	Duarte	Alhambra	Sierra Madre
	<p>Duarte Station Specific Plan (Esperanza and Solana): Max Building Height: 120 feet max. height except within 100 feet of R-1 zone height is limited to 90 feet</p> <p>Building Height Projections: Architectural features are allowed to project up to a maximum of 10 feet above the maximum allowed height, subject to Design Review. Architectural features include rooflines (balustrades, pediments, statuary, dormer windows, cross gables), masts, towers, turrets, eaves, rafters, non-habitable building façade, skylights or roof windows. Elevator, mechanical equipment, and equipment penthouses are not subject to height limits as long they meet the screening design guidelines.</p> <p>Buildings shall be well articulated by changes in roof heights and vertical planes to reduce the appearance of bulk and create interesting building silhouettes.</p> <p>Duarte Town Center Specific Plan: Max Height Residential and Mixed Use: (Tier 1) AREA 1 Town Center Commercial Core - none Area 2 - Mixed Use Corridor - 2 stories, 35 feet Area 3 - Mixed Use Town Center - none Area 4 - Mixed Use Neighborhood - none Area 5 - Mixed Use Corridor - none Area 6 - Mixed Use Corridor - 4 stories, 50 feet Area 7A - Mixed Use Neighborhood - none Area 7B - Mixed Use Neighborhood - 2 stories, 35 feet Area 8 - Residential Town Center - 4 stories, 50 feet Area 9 - Mixed Use Neighborhood - 2 stories, 35 feet</p> <p>Max Height Mixed Use: (Tier 2) AREA 1 Town Center Commercial Core - none Area 2 - Mixed Use Corridor - none Area 3 - Mixed Use Town Center - none Area 4 - Mixed Use Neighborhood - 3 stories, 40 feet Area 5 - Mixed Use Corridor - none Max Height Residential and Mixed Use: (Tier 2) Area 6 - Mixed Use Corridor - 2 stories, 35 feet Area 7A - Mixed Use Neighborhood - 3 stories, 40 feet Area 7B - Mixed Use Neighborhood - none Area 8 - Residential Town Center - none Area 9 - Mixed Use Neighborhood - none</p> <p>Max Height Residential and Mixed Use: (Tier 3) AREA 1 Town Center Commercial Core - none Area 2 - Mixed Use Corridor - 4 stories, 50 feet Area 3 - Mixed Use Town Center - 4 stories, 50 feet Area 4 - Mixed Use Neighborhood - 4 stories, 50 feet Area 5 - Mixed Use Corridor - 4 stories, 50 feet Area 6 - Mixed Use Corridor - 4 stories, 50 feet Area 7A - Mixed Use Neighborhood - 4 stories, 50 feet Area 7B - Mixed Use Neighborhood - 4 stories, 50 feet Area 8 - Residential Town Center - none Area 9 - Mixed Use Neighborhood - 4 stories, 50 feet</p> <p>Minimum Ground Floor Height: 14 feet for Retail, 12 feet for Office, 11 feet for Residential (Conversions of use in existing buildings shall not be required to meet this requirement.)</p> <p>Minimum Street Wall Height: 25 feet on Huntington Drive only</p> <p>R-2 Two-Family Residential Zone (Medium Density): 35 ft or 2 stories, whichever is less</p> <p>R-3 Multiple-Family Residential Zone (Medium Density): 40 ft or 3 stories, whichever is less</p> <p>R-4 Multiple-Family Residential Zone (High Density): 50 ft or 4 stories, whichever is less</p>	<p>RM (Residential Medium) Zone: 35 feet max 3 stories max</p> <p>RH (Residential High) Zone: Max Feet: Area bounded by Atlantic Blvd on the west, Woodward Ave on the north, Commonwealth Ave on the south, and Chapel Ave on the east, and parcels on major arterial streets within 1,300 feet of a freeway interchange: 75 Other areas: 45</p> <p>Max Stories: Area bounded by Atlantic Blvd on the west, Woodward Ave on the north, Commonwealth Ave on the south, and Chapel Ave on the east, and parcels on major arterial streets within 1,300 feet of a freeway interchange: 6 Other areas: 5</p> <p>Central Business District (CBD) Zone: max building height (feet): 75 max building height (stories): 5</p> <p>East Main Commercial (EMC) Zone: max building height (feet): 35 max building height (stories): 3</p> <p>Commercial Mixed-Use (CMU) Zone: max building height (feet): 40 within 50 feet of a Residential Zoning District, otherwise 75 max building height (stories): 3 within 50 feet of a Residential Zoning District, otherwise 5</p> <p>Professional Office (PO) Zone: max building height (feet): 40 within 50 feet of a Residential Zoning District, otherwise 75 max building height (stories): 3 within 50 feet of a Residential Zoning District, otherwise 5</p> <p>Industrial (I) Zone: max building height (feet): 40 within 50 feet of a Residential Zoning District, otherwise 55 max building height (stories): 3 within 50 feet of a Residential Zoning District, otherwise 5</p> <p>Chapter 23.13 Building and Site Design Standards: Ground floor height, non-residential uses. The minimum ground floor height for non-residential uses is 14 feet measured floor to ceiling.</p>	<p>R-3-20 and R-3-30 (High Density Residential Zones): A third story building element shall be permitted, provided that this element is located more than forty feet away from any public street and has no horizontal dimension longer than forty-five feet. Additionally, the total floor area of these elements shall equal no greater than twenty percent of the gross lot area. For any project containing a third story, the height limit shall be measured in compliance with the calculation method described in Section 17.20.040 for the R-1 zone, except that the maximum height shall be thirty feet instead of twenty-five feet.</p> <p>Commercial Zone: Review of a proposed design shall be related to the surrounding existing development with greater emphasis placed upon compatibility with adjacent development related to: a. Bulk or mass height</p> <p>No building structure shall exceed a height of thirty feet and no building structure shall exceed two stories in the C zone.</p> <p>RHO (Religious Housing Overlay) Zone: a. Height Limit. No building shall exceed either thirty-five feet in height or three stories above grade, as calculated in the manner illustrated in Section 17.28.080 C. b. Height Adjacent to Public Streets. No building shall exceed either thirty feet in height or two stories above grade within forty feet from any public street other than Michilinda Avenue. c. Height Adjacent to R-1 Zone. For yards abutting an R-1 zoned lot, an encroachment limit shall be established which is determined at the point where the wall height is twenty feet, and using a forty-five-degree angle inwards toward the property to create additional setback. (See illustration in Section 17.28.080 F.7.)</p>
	<p>Duarte Station Specific Plan (Esperanza and Solana): The façades facing major streets shall not have blank walls, service entrances, or other features that are detrimental to the pedestrian experience. Architectural design, modulation, and interest should be articulated on all sides of the building.</p> <p>Floor elevations of building frontages need to be at the sidewalk level, and the use of awnings, change in material, and architectural articulation should be used to create a pedestrian-scaled public realm regardless of the overall scale and mass of the building.</p> <p>Large expanses of blank façade walls are not permitted. Façades directly facing the street shall be broken into distinct modules or bays along the frontage using three-dimensional surface modulations that extend the human-scaled architectural character and cadence of more active façade areas. The modulations can be achieved with the use of recesses, projections, change in color or material. The depth of recesses and projections should be a minimum of two feet.</p> <p>Where possible, horizontal modulation of adjacent buildings should relate across façades to create a consistent pedestrian scale street façade.</p> <p>Multi-Family Residential and Mixed-Use - Street-facing façades of residential buildings should include stoops, porches, recessed windows, bay windows, and balconies to provide visual interest.</p> <p>Duarte Town Center Specific Plan: Building façades should be broken into smaller massings of colonnades to create a more intimate human scale. Create virtual boundaries by a varying/change of level, materials, textures, and color.</p> <p>All building facades should avoid blank walls and provide the highest level of articulation on all walls visible from adjacent streets and public spaces.</p> <p>Murals, espaliers/trellises and vines should be placed on any large wall expanse.</p> <p>City of Duarte Residential architectural and design standards (applies to all residential zones): For any new structure or addition, all façades visible from a public right-of-way shall incorporate features that eliminate blank, unarticulated walls; add visual interest; avoid clutter; and display a distinctive architectural style. Varied modulation for exterior façade surfaces is encouraged.</p>	<p>West Main Corridor Master Plan: -emphasize pedestrian-scaled details at street level; canopies, awnings, and architectural lighting are especially appropriate at building entrances</p>	
Human Scaled Design			

Exhibit A	Duarte	Alhambra	Sierra Madre
	<p>Duarte Station Specific Plan (Esperanza and Solana): Special standards and guidelines are established for the design of buildings with ground floor commercial space along certain frontages. Minimum floor-to-ceiling heights ensure that the space will serve the needs of retail and restaurant uses that may locate in the space during the lifetime of the building.</p> <p>Floor elevations of building frontages need to be at the sidewalk level, and the use of awnings, change in material, and architectural articulation should be used to create a pedestrian-scaled public realm regardless of the overall scale and mass of the building.</p> <p>As a unifying element, brick should be used on all buildings as a predominant design feature. It may be used at the ground floor to create a base to the building, as entire wall elements, as the material for a main tower feature, or as panel or framing elements between window walls. Where brick is used, there shall be at least some minor change in building plane to express the material change. Surface applied brick should either terminate in a concrete base or extend to the ground, and should not appear to float.</p> <p>Duarte Town Center Specific Plan: Use articulation in form, including changes in wall planes, upper-story building setbacks and/or projecting or recessed elements.</p> <p>Buildings should create a contextual fit with articulated building form including strong massing and horizontal division (base, middle, top).</p> <p>The base, middle, and top of the building should be emphasized. This allows the building to be viewed from several different vantage points, both near and far from the structure, without looking unnatural.</p>	<p>Chapter 23.13 Building and Site Design Standards: In addition to the façade articulation requirement in division B(3)(b)1, above, upper and lower stories in buildings of three or more stories shall be distinguished by incorporating one or more of the following features. These features may be applied to the transitions between any floors, except where otherwise specified. a. A change in façade materials, along with a change in plane at least one inch in depth at the transition between the two materials. b. A base treatment at the ground floor consisting of a material such as brick, stone, concrete masonry, or other material distinct from the remainder of the façade and projecting at least one inch from the wall surface of the remainder of the building. c. Setting back the top floor or floors of the building at least five feet from the remainder of the façade.</p> <p>West Main Corridor Master Plan: -make upper floors visually distinct from the ground floor; residential use should be distinguishable from commercial use</p> <p>Chapter 23.13 Building and Site Design Standards: Buildings less than three stories. All buildings less than three stories and over 50 feet wide shall provide a massing break with a minimum width of 20 feet and a minimum depth of 2.5 feet for every 50 feet of façade length.</p> <p>Buildings three or more stories. All buildings with three or more stories and over 50 feet wide shall provide a massing break with a minimum width of 20 feet and a minimum depth of five feet for every 50 feet of façade length.</p> <p>West Main Corridor Master Plan: -introduce elevation breaks; upper floor setbacks are encouraged -respond to adjacent residential use with a sensitive transition in scale and massing; a step back in building height or break in massing is appropriate.</p> <p>Chapter 23.13 Building and Site Design Standards: Tenant space depth, non-residential uses. Non-residential ground floor interior tenant spaces shall be a minimum of 60 feet in depth for a minimum of half of the width of the tenant space and a minimum of 40 feet in depth elsewhere, except as exempted by the Director through the approval of a modification on small or constrained sites.</p>	<p>Commercial Zone: Architectural treatment shall be applied to all building elevations.</p>
Differentiation in Design Among Stories			
Building Breaks			
Non-Residential Space Depth			
Corner Buildings			
Pedestrian Experience Along Sidewalk			
	<p>Duarte Station Specific Plan (Esperanza and Solana): Building corners that face an intersection should strive for a distinctive form with a high level of articulation. Corner treatments may include a change in height or architectural style, materials, roof form, or window pattern, and are encouraged to create a pedestrian gathering experience.</p> <p>Multi-Family Residential and Mixed-Use - Building corners that face an intersection should strive for a distinctive form with a high level of articulation. Corner treatments could include a change in height, a definition of a public plaza, or a change in architectural style, windows, or materials.</p>		
Architectural Corner Elements			
Towers at Corner			
Other Corner Design Features	<p>Duarte Station Specific Plan (Esperanza and Solana): Material changes should not occur at external corners but should occur at interior corners or with a return of at least six feet from the external corners or other logical terminations.</p>		
Materials, Finishes, and Color			

Appendix E: SGVCOG Regional Objective Design Standards Research Memorandum

Exhibit A	Duarte	Alhambra	Sierra Madre
	<p>Duarte Station Specific Plan (Esperanza and Solana): Entries should be inviting from the street with adequate weather protection.</p> <p>Multi-Family Residential and Mixed-Use - Common entries should be a predominant feature of front façades and should have a scale that is in proportion to the size of the building and number of units being accessed. Larger buildings should have a prominent, centralized building entrance. -Building sides that face a public street, drive, or common space should be the first choice for entry location.</p> <p>Duarte Station Specific Plan (Esperanza and Solana): Main building entries (i.e., those serving multiple units) should be differentiated from individual street-level unit entries with special detailing, awnings, canopies, or multi-story forms.</p> <p>Doorways should be clearly identified with change in material, change in plane, or with architectural elements such as a canopy.</p> <p>Multi-Family Residential and Mixed-Use - Common entries should be a predominant feature of front façades and should have a scale that is in proportion to the size of the building and number of units being accessed. Larger buildings should have a prominent, centralized building entrance.</p>	<p>Chapter 23.13 Building and Site Design Standards: (1) Buildings located within 30 feet of a front or street side lot line shall be oriented toward the adjacent front or street side lot line with the building frontage parallel to the fronting public sidewalk. The primary building entrance shall face the public sidewalk. (2) All buildings located in the interior of a site shall have an entrance from a pedestrian walkway that is a minimum of four feet wide and connects to a public sidewalk. (3) In the CBD Zone, one or more public entrances shall be provided at the rear of all buildings which face Main Street.</p>	
Location of Entries			
Demarcation of Entries		<p>West Main Corridor Master Plan: -provide well marked, articulated building entrances -encourage a frequent cadence of storefront entrances along Main St</p>	
	<p>Duarte Station Specific Plan (Esperanza and Solana): Multi-Family Residential and Mixed-Use - Storefronts on the ground floor of mixed-use buildings shall be of sufficient depth to support the anticipated use and are encouraged to have a minimum depth of 40 feet. -All ground floor units within five feet of finished grade are encouraged to have their principal entrance from the street, pedestrian walkway, or open space. If individual entries are not provided, then individual private areas such as balconies or decks should be provided that front on to the street, pedestrian walkway, or open space. -Residential entries should be clearly identifiable from the retail/service entry. -The use of awnings is encouraged to provide shelter and shade along the sidewalk for mixed-use buildings. Awnings should be no wider than a single storefront or architectural bay (whichever is narrower).</p> <p>Duarte Town Center Specific Plan: REQUIRED COMMERCIAL STOREFRONTS Ground-floor commercial uses are required along the streets identified in Figure 3-7 (Required Commercial Storefronts). Along the streets identified, a building shall devote a minimum of 75 percent of its street-side building frontage to commercial storefronts. Certain projects may be allowed additional non-commercial building frontage through an administrative exception detailed in the Minor Modifications process (Chapter 7). Retail, service, office, and hotel uses shall court toward the 75 percent required commercial storefronts. However, the ground floor space within 150 feet of a key intersection shall be designed specifically for retail, service-oriented businesses, and/or restaurant uses. Up to 50 percent of any required commercial storefront (linear) located beyond 150 feet of a key intersection may be occupied by live-work uses.</p> <p>Ground Floor Residential Uses: -New residential buildings shall provide transitional spaces in the form of stoops, overhangs, and porches between public areas and entrances. -Where exterior individual entries are provided, a distinctive entry should be established for each, defined with architectural elements consistent with the architectural style of the development as a whole. -Decorative lighting should be provided at entries. -If exterior staircases are used, they should be incorporated into the overall architectural massing of the building. -The use of metal staircases is discouraged.</p> <p>Ground Floor Retail: -Ground-floor space designed for retail or other active uses shall orient tenant spaces to the street and maximize storefronts and entries along the sidewalks to sustain street-level interest and promote pedestrian activity. -Ground-floor design shall be high quality and pedestrian oriented. -Storefront configurations and details should provide a sense of human scale, variety, and interest within the overall context of the buildings. -Ground-floor retail space should wrap the corner onto the intersecting streets. -The primary entrance to each street-level tenant space that has its frontage along a public street shall be provided from that street. -The primary entrance to each street-level tenant that does not have its frontage along a public street shall be provided from a pedestrian paseo, courtyard, or plaza which is connected to the public street. -Wall openings, such as storefront windows and doors, shall comprise at least 50 percent of a building's street-level façade. -Clear glass for wall openings, i.e., doors and windows, shall be used along all street-level façades for maximum transparency, especially in conjunction with retail uses. Dark tinted, reflective, or opaque glazing is not permitted for any required wall opening along street level façades.</p>	<p>Chapter 23.13 Building and Site Design Standards: Non-residential: Additional entrance requirements, ground floor non-residential uses. (a) There shall be a minimum of one entrance for every 50 feet of building frontage with a maximum separation of 100 feet between entrances. (b) Buildings located on corners shall provide an entrance toward each street or have a corner entrance that provides a common entrance to the building from both streets.</p> <p>Residential Entrances: (a) Shared entrances. All buildings that provide access to more than one unit from a shared exterior entrance shall provide a minimum of one primary shared entranceway that leads to a common area, such as a lobby or community space, a minimum of ten-foot wide and ten-foot deep, and that is emphasized utilizing at least one of the following methods: 1. A roofed projection over the door (such as an awning, canopy, or overhang) with a minimum depth and width of five feet. 2. A recessed entry bay with a minimum depth and width of five feet. 3. Incorporating the entrance into a vertical mass that extends two or more feet above the height of the first floor plate vertical mass. 4. A landing, deck, or stoop with a minimum depth of six feet and minimum width of eight feet. 5. Transparent windows or openings that comprise a minimum of 50% of the area located within 20 feet of the midpoint of the primary building entrance. Glass is considered transparent where it has a transparency higher than 80% and external reflectance of less than 15%.</p> <p>Individual entrances. All residential units accessed through individual entrances at the ground level shall provide a minimum of one primary individual entranceway with a projection (such as a covered porch) or recess with a minimum depth and width of three feet and a minimum area of nine square feet or a landing, deck, uncovered porch, or stoop with a minimum depth and width of six feet.</p> <p>West Main Corridor Master Plan: -differentiate storefront entrances from a residential or main building entrance -allow for creativity and individual expression in storefront design, provided they are compatible with the overall building design.</p> <p>West Main Corridor Master Plan: -offer inviting entries and expansive storefront windows with engaging displays that animate the street -introduce details and elements that provide visual relief, for example pilasters, course lines, windows heads and sills, brackets, cornices</p> <p>Alhambra MC AMC 23.13.020 Building Design Requirements: (A) Building entrances and orientation. (1) Buildings located within 30 feet of a front or street side lot line shall be oriented toward the adjacent front or street side lot line with the building frontage parallel to the fronting public sidewalk. The primary building entrance shall face the public sidewalk. (2) All buildings located in the interior of a site shall have an entrance from a pedestrian walkway that is a minimum of four feet wide and connects to a public sidewalk. (3) In the CBD Zone, one or more public entrances shall be provided at the rear of all buildings which face Main Street. (4) Additional entrance requirements, ground floor non-residential uses. (a) There shall be a minimum of one entrance for every 50 feet of building frontage with a maximum separation of 100 feet between entrances. (b) Buildings located on corners shall provide an entrance toward each street or have a corner entrance that provides a common entrance to the building from both streets. (5) Additional entrance requirements, residential uses. (a) Shared entrances. All buildings that provide access to more than one unit from a shared exterior entrance shall provide a minimum of one primary shared entranceway that leads to a common area, such as a lobby or community space, a minimum of ten-foot wide and ten-foot deep, and that is emphasized utilizing at least one of the following methods: 1. A roofed projection over the door (such as an awning, canopy, or overhang) with a minimum depth and width of five feet. 2. A recessed entry bay with a minimum depth and width of five feet. 3. Incorporating the entrance into a vertical mass that extends two or more feet above the height of the first floor plate vertical mass. 4. A landing, deck, or stoop with a minimum depth of six feet and minimum width of eight feet. 5. Transparent windows or openings that comprise a minimum of 50% of the area located within 20 feet of the midpoint of the primary building entrance. Glass is considered transparent where it has a transparency higher than 80% and external reflectance of less than 15%.</p>	
Mixed Use Buildings - Difference between Retail Entrances vs Residential Entrances			

Exhibit A	Duarte	Alhambra	Sierra Madre	
	<p>Duarte Station Specific Plan (Esperanza and Solana): As a unifying element, brick should be used on all buildings as a predominant design feature. It may be used at the ground floor to create a base to the building, as entire wall elements, as the material for a main tower feature, or as panel or framing elements between window walls. Where brick is used, there shall be at least some minor change in building plane to express the material change. Surface applied brick should either terminate in a concrete base or extend to the ground, and should not appear to float.</p> <p>In addition to brick as a required material, other façade materials that are encouraged include corrugated metal, metal panels, smooth stucco, and cementitious panels. Detailing should reinforce the industrial aesthetic of the area. Window walls are encouraged both as wall plane and corner accents and a creative approach to window shapes, sizes, and mullion patterns is highly desirable. Accent materials that are encouraged include cut stone, tile, glass block, and well-detailed smooth concrete.</p> <p>Balconies, decks, and handrails should be steel or other metal and have industrial-inspired scale and detailing. Exposed steel columns are encouraged.</p> <p>Awnings are encouraged along street frontages and should be metal or metal and glass. Canvas and fabric awnings are discouraged.</p> <p>For trellises, marquees, and architectural canopies, materials, colors, and form should be derived from the building architecture, such as a trellis painted the same color as a building's trim scheme is appropriate.</p> <p>All materials used should be durable, of high quality, and properly installed.</p> <p>Materials should be attractive, sustainable, low maintenance, and appropriate to the architectural character.</p> <p>Materials should be incorporated in a manner that they do not appear to be merely surface applications but as an integral component of the architectural style.</p> <p>Roof materials should complement the materials and colors of the façades and provide texture or relief.</p> <p>Rain gutters and down spouts should be integrated into the façade. At a minimum, their color should blend with adjacent surfaces.</p> <p>Partially submerged parking podiums that project above grade should either be integrated into the architectural character of the building above utilizing cladding or building with materials that extend down from the portions of the building above or be built with contrasting materials of a more substantial and permanent character than the portions of the building above to create a base.</p> <p>Trellises, architectural canopies, balconies, and other such design elements should derive their materials, colors, and form from the building architecture.</p> <p>Duarte Town Center Specific Plan: Create visual interest in building façades and break up the mass of large-scale buildings with articulation in form, architectural details, and changes in materials and colors.</p> <p>Vary materials, colors, and textures to enhance key components of a building's façade (i.e., window trims, entries, projecting elements, etc.).</p> <p>Building materials, colors, fenestration, scale, and massing are to be compatible with the overall architectural style.</p> <p>Materials shall be applied in a consistent manner to all façades of the project.</p> <p>Materials and finishes should be used consistently and be appropriate to the intended architectural style of the building.</p> <p>High-quality, long-lasting materials should be used for exterior window sills and trims which are consistent with the overall architectural style of the building.</p> <p>Roof materials should complement the materials and colors of the façades and provide texture or relief.</p> <p>Rain gutters and downspouts should be integrated into the façade. At a minimum, their color should blend with adjacent surfaces.</p> <p>Trellises, architectural canopies, balconies, and other such design elements should derive their materials, colors, and form from the building architecture.</p> <p>Mixed Use Standards: An overall design palette should include building materials and textures that define each use as part of an overall theme.</p> <p>City of Duarte Residential architectural and design standards (applies to all residential zones): Materials and finishes shall be of a consistent theme, shall match the style of the residential structure, and shall be consistently applied to all façades.</p> <p>Duarte Town Center Specific Plan: Materials and finishes should be used consistently and be appropriate to the intended architectural style of the building.</p> <p>Duarte Station Specific Plan (Esperanza and Solana): For trellises, marquees, and architectural canopies, materials, colors, and form should be derived from the building architecture, such as a trellis painted the same color as a building's trim scheme is appropriate.</p> <p>Trellises, architectural canopies, balconies, and other such design elements should derive their materials, colors, and form from the building architecture.</p> <p>Duarte Town Center Specific Plan: Create visual interest in building façades and break up the mass of large-scale buildings with articulation in form, architectural details, and changes in materials and colors.</p> <p>Vary materials, colors, and textures to enhance key components of a building's façade (i.e., window trims, entries, projecting elements, etc.).</p> <p>Building materials, colors, fenestration, scale, and massing are to be compatible with the overall architectural style.</p> <p>Contrasting colors should be used for trims, windows, doors, and other key architectural elements.</p> <p>Roof materials should complement the materials and colors of the façades and provide texture or relief.</p>	<p>Chapter 23.13 Building and Site Design Standards: In addition to the façade articulation requirement in division B(3)(b)1. above, upper and lower stories in buildings of three or more stories shall be distinguished by incorporating one or more of the following features. These features may be applied to the transitions between any floors, except where otherwise specified. a. A change in façade materials, along with a change in plane at least one inch in depth at the transition between the two materials. b. A base treatment at the ground floor consisting of a material such as brick, stone, concrete masonry, or other material distinct from the remainder of the façade and projecting at least one inch from the wall surface of the remainder of the building.</p> <p>Exterior building colors and materials. (a) Each façade shall have three or more colors and three or more materials, exclusive of windows. (b) Fluorescent and neon colors are prohibited. (c) The following materials are prohibited. 1. Vinyl siding. 2. T-111 plywood siding.</p> <p>West Main Corridor Master Plan: -use materials and colors to enhance a building's visual quality, requiring compatible materials on all sides -encourage masonry and hand-troweled plaster as the most appropriate exterior wall types -emphasize especially durable and high quality materials at the street level -avoid the use of applied foam ornamentation -discourage the use of reflective, opaque or highly tinted glass</p> <p>City of Duarte Residential architectural and design standards (applies to all residential zones): Materials, colors and textures generally should be compatible with those of adjacent and other nearby buildings and the overall character of the neighborhood.</p> <p>R-3-13 Zone (Medium/High Density Residential Zone) and RHO (Religious Housing Overlay) Zone: Materials, colors and textures generally should be compatible with those of adjacent and other nearby buildings and the overall character of the neighborhood.</p> <p>Commercial Zone: The following building materials or those determined by the director to be similar to them shall be utilized in all construction in the commercial zone: 1. Roof materials intended to be viewed, including but not limited to tile or slate. 2. Brick, tile, textured concrete, tinted concrete or exposed aggregate patios and walkways. 3. Decorative masonry materials such as bricks, stone or slump stone. 4. Heavy rough textured wood beams, headers, trim and siding. 5. Textured stucco.</p> <p>Review of a proposed design shall be related to the surrounding existing development with greater emphasis placed upon compatibility with adjacent development related to: c. Building materials</p> <p>R-3-13 Zone (Medium/High Density Residential Zone): Materials, colors and textures generally should be compatible with those of adjacent and other nearby buildings and the overall character of the neighborhood.</p> <p>R-3-13 Zone (Medium/High Density Residential Zone): Materials, colors and textures generally should be compatible with those of adjacent and other nearby buildings and the overall character of the neighborhood.</p> <p>Commercial Zone: Earth tone or natural colors shall be utilized throughout with the use of bright, nonpastel colors for the purpose of accent; however, such accent colors shall not be used to such a degree as to become the dominant color of any structure.</p> <p>Review of a proposed design shall be related to the surrounding existing development with greater emphasis placed upon compatibility with adjacent development related to: b. Colors</p>		
Materials				
Finishes				
Colors				
Character				
Entry Design Elements				
Residential Privacy				
Proximity to Commercial Uses/Non-Compatible Uses				
Height of Windows				
Location of Material Changes				
Entries				

Appendix E: SGVCOG Regional Objective Design Standards Research Memorandum

Exhibit A	Duarte	Alhambra	Sierra Madre
Sight Lines into Windows/Balconies/Private Patios Design of Ground Floor Residential Units Direction of Windows	Duarte Station Specific Plan (Esperanza and Solana): Windows should be of a scale and grouping to form portions of the wall, rather than punched openings within a wall. They shall be steel, aluminum, or clad to have the look of metal. Vinyl windows are strongly discouraged in any buildings over three stories. Windows at the ground floor along public streets should be storefront or give the appearance of storefront glazing. In residential units with narrow side yards, side elevation windows should be placed offset from those of the adjacent unit or use obscure glass as appropriate to provided for privacy.	Chapter 23.13 Building and Site Design Standards: Balconies and decks situated above the first floor shall be located at least 15 feet away from any interior property line to minimize "overviewing" onto adjacent residential properties. This provision shall not apply to balconies or decks located directly above an attached or detached garage that is located within the front yard setback of a sloping lot pursuant to § 23.04.030(A), Sloping Lot Adjustment.	R-3-13 Zone (Medium/High Density Residential Zone) and RHO (Religious Housing Overlay) Zone: Building siting should maximize privacy through placement of windows, balconies, landscaping, and design of outdoor spaces. Minimize negative impact on views from adjacent properties.
Views	Duarte Station Specific Plan (Esperanza and Solana): Windows should be of a scale and grouping to form portions of the wall, rather than punched openings within a wall. They shall be steel, aluminum, or clad to have the look of metal. Vinyl windows are strongly discouraged in any buildings over three stories. Windows at the ground floor along public streets should be storefront or give the appearance of storefront glazing. Windows should be appropriate to the building's architectural style and combined and arranged to establish clear and rhythmic patterns as appropriate for both the building's architectural style and scale. Window frames should be of a high-quality metal material that is consistent with the proposed architectural vocabulary. Windows visible from a street or courtyard, including those on all facades of the buildings that front onto public or private streets or access ways, should have appropriately articulated header, jamb, and sill details to match the aesthetic of the building. Creative window shape, sizes, mullion use, mullion thickness, architectural tinting, and other design features that enhance building articulation are encouraged. No blank, opaque, or reflective windows are allowed. Artwork, decorative metal work, unique and custom window pattern tints may also be considered. Although consistency of window use is generally desirable, windows may be provided in various shapes and sizes, provided they are appropriate to the building's architectural style or as accents. Multi-Family Residential and Mixed-Use -Large display windows (large panes or divided lites) are strongly encouraged. -Clear glass should be used. Colored or reflective glass is not appropriate. Subtle window tinting may be appropriate if part of a comprehensive design theme. Duarte Town Center Specific Plan: Windows should be located at a pedestrian scale at the street level and to maximize daylighting and views for the interior. Windows and doors should be designed within a single façade to have the same style, height, and scale with the building elevation. Windows and doors should be designed as accent elements with details such as shutters, moldings, and divided lites. City of Duarte Residential architectural and design standards (applies to all residential zones): Window and door design and placement shall be consistent with the overall architectural style of the structure and consistent with all windows/doors visible from the public right-of-way.	Chapter 23.13 Building and Site Design Standards: Windows and openings: (a) No wall facing a public right-of-way shall run in a continuous plane of more than 30 feet without a window, door, or other opening. (b) Non-residential uses: building transparency/required openings. Exterior walls facing and within 30 feet of a front or street side lot line or public sidewalk shall include windows, doors, or other openings for at least 50% of the building wall area located between two and a half and seven feet above the level of the sidewalk. 1. Design of required openings. Openings fulfilling this requirement shall have transparent glazing and provide views into work areas, display areas, sales areas, lobbies, or similar active spaces, or into window displays that are at least three feet deep. 2. Reductions. The Director may approve a modification to reduce or waive the building transparency requirement where one of the following findings can be made: a. The proposed use has certain operational characteristics with which providing the required windows and openings is incompatible; and b. Street-facing building walls will exhibit architectural relief and detail, and will be enhanced with landscaping in such a way as to create visual interest at the pedestrian level. (c) Residential uses: window trim or recess. Windows for residential uses shall have trim at least one-half inch in depth, or be recessed at least two inches from the plane of the surrounding exterior wall.	Commercial Zone: Review of a proposed design shall be related to the surrounding existing development with greater emphasis placed upon compatibility with adjacent development related to: f.Views
Window Requirements			
Outdoor Dining Patio Dining	Duarte Station Specific Plan (Esperanza and Solana): Outdoor dining areas can encroach in the pedestrian public right-of-way as long as there is a clear pedestrian passage that complies with accessible standards, or as otherwise specified in Table 3-4 (Frontage Class Standards). Location and size of such encroachments are subject to the design review process. Duarte Town Center Specific Plan: Chairs and tables for outdoor dining and carts for merchant display are allowed in the public right-of-way (i.e., in sidewalk and parklet areas) with a required minor use and encroachment permit. Uses shall maintain a minimum five-foot-wide unobstructed portion of public sidewalk corridor that is clear and unimpeded for pedestrian traffic. The use shall keep the full width of the building entrance clear and unimpeded for building access. Outdoor furniture, including but not limited to chairs, tables, umbrellas, heat lamps, windcreens, bus stops, partitions, planters, etc., shall not be permanently fixed into the public right-of-way without prior approvals from the City (i.e., a revocable encroachment permit issued by the Building Department and/or the City Council).	Central Business District (CBD) Zone, East Main Commercial (EMC) Zone, and Commercial Mixed-Use (CMU) Zone: Frontage improvements. The area between buildings and the property line shall be improved as part of a wider sidewalk, outdoor dining/seating area, or with landscaping. Modifications. These requirements may be modified or waived through approval of a modification upon finding that: 1. Entry courtyards, plazas, entries, or outdoor eating areas are located adjacent to the property line and buildings are built to the edge of the courtyard, plaza, or dining area; or 2. The building incorporates an alternative entrance design that creates a welcoming entry feature facing the street or is designed in a manner that compliments adjacent or surrounding land uses.	
Sidewalk Dining Sun Shade Noise Barriers Furniture Lighting Hours Location		West Main Corridor Master Plan: -Accommodate outdoor dining while maintaining comfortable pedestrian flows.	
Residential Open Space		Chapter 23.13 Building and Site Design Standards: Required amenities. Recreational amenities shall be required on all projects of four or more units. The amenities shall include one or more of the following: swimming pool, spa, recreation room with ping pong table and lounge furniture or billiard table, children's play equipment, barbecue and picnic table, tennis court, bocce ball, weight room or sauna, pet friendly amenities including but not limited to drink stations, dog walks/parks, etc., or other similar amenities West Main Corridor Master Plan: -include site amenities and recreational facilities, such as a pool, jacuzzi, seating/lounging areas -use plants, furniture, and lighting to shape, embellish, and enliven amenity courts.	
Open Space Amenities		Chapter 23.13 Building and Site Design Standards: Slopes shall not exceed 10%. West Main Corridor Master Plan: -Provide courtyards accessible to project residents as communal outdoor space -introduce a rich, yet coordinated palette of landscape materials to provide scale, texture, color.	
Open Space Design Orientation	Duarte Station Specific Plan (Esperanza and Solana): Multi-Family Residential and Mixed-Use - Porches and balconies that face streets should be incorporated into the materials and design of the building. Front yard patios can be used or be a part of the entry path or a separate space.		

Exhibit A	Duarte	Alhambra	Sierra Madre	
Open Space Requirement	Duarte Station Specific Plan (Esperanza and Solana): Residential Group Open Space - Minimum 200 sf per residential unit required. Private open space is not required for each unit. However, if provided, it may be deducted from the total open space requirement. Each square foot of private open space and/or rooftop common open space shall be considered equivalent to two square feet of group open space and may be so substituted. Non-Residential Group Open Space - 15% of net lot area or as determined by an approved Group Open Space Plan. Duarte Town Center Specific Plan: RESIDENTIAL OPEN SPACE REQUIRED The required minimum amount of open space shall be 125 square feet per residential unit. The minimum open space may be met through a combination of common, private, and/or quasipublic open space provided on site. All required open space shall be usable. Usable open space shall be improved to support residents' passive and/or active use. Such open space shall be located on the same parcel as the dwelling units for which it is required. The computation of such open space shall include no obstructions other than devices and structures designed to enhance its usability, such as swimming pools, changing facilities, fountains, planters, benches, and landscaping. Usable open space does not need to be located on the ground. Rooftop gardens and rooftop landscaping, including rooftops above parking structures, may be used to satisfy the open space requirement. The requirement for open space shall not be satisfied through the utilization of required setbacks, parking areas, driveways, or service areas. Areas designed to accommodate storm water retention may satisfy a portion of the requirement for open space if additional pedestrian amenities are provided near the space in a manner that provides for usability. Compliance with this requirement shall be evaluated by the Director in the review process. Mixed-use buildings shall be arranged to create opportunities for open space for the residential uses. In general, open space areas for residential uses shall be separated from nonresidential uses on the site. However, the sharing of open space may be permitted by the responsible review authority when it is clear that the open space will provide direct benefit to residents of the project and subject to the following limitations: 1. Horizontal Mixed Use Share. Up to 30 percent of the required open space for residential uses in a horizontal mixed-use project may be provided within the nonresidential component. 2. Vertical Mixed Use Share. Up to 50 percent of the required open space for residential uses in a vertical mixed-use project may be provided within the nonresidential component. R-3 Multiple-Family Residential Zone (Medium Density): private open space requirement (ground floor): 200 sf per unit private open space requirement (upper floor): 100 sf per unit common open space: 200 sf per unit R-4 Multiple-Family Residential Zone (High Density): private open space requirement (ground floor): 200 sf per unit private open space requirement (upper floor): 100 sf per unit common open space: 200 sf per unit Duarte Station Specific Plan (Esperanza and Solana): Private usable open space located at ground level shall have a minimum area of 100 square feet and a rectangle inscribed within it shall have no dimension less than eight feet. The minimum area of above ground-level space shall be 50 square feet, and a rectangle inscribed within it shall have no dimension less than five feet. Private usable open space shall be adjacent to, and not more than four feet above or below the floor level of the dwelling unit served, or located on a rooftop with private access via the unit. R-3 Multiple-Family Residential Zone (Medium Density) and R-4 Multiple-Family Residential Zone (High Density): -Private open space must be contiguous to the unit it serves. -Any single private open space area shall have minimum dimensions — depth or width — of 10 feet. -Balconies, where provided, shall have minimum dimensions of four feet by six feet.	Chapter 23.13 Building and Site Design Standards: The area provided to meet the open space requirement may count toward other site requirements such as landscaping, amenities, and stormwater retention and control if the area provided as open space also meets the criteria of those individual requirements. Minimum of 300 sf of open space per unit. 150 sf of the 300 sf must be provided as common open space. The balance of the required open space may be provided as private or common open space. SRO Open Space Requirement: Single room occupancy developments shall provide 15 square feet of open space per unit, which may be provided as private or common open space.	Chapter 23.13 Building and Site Design Standards: The balance of the 150 sf required open space may be provided as private or common open space. Private open space shall be accessible to only one dwelling unit by a doorway to a habitable room or hallway.	R-3-13 Zone (Medium/High Density Residential Zone): 500 square feet per dwelling unit of open space. R-3-20 and R-3-30 (High Density Residential Zones): 250 square feet per dwelling unit of on-site open space shall be provided on the ground level for use by residents. Open spaces may be common or private. In order to be counted toward the open space requirement, the minimum width and length of each space shall be ten feet. Driveways and other vehicular access areas shall not count toward the open space requirement. RHO (Religious Housing Overlay) Zone: 175 square feet per dwelling unit of on-site open space shall be provided for use by residents.
Private Open Space Standards	Duarte Station Specific Plan (Esperanza and Solana): Residential Group Open Space - Minimum 200 sf per residential unit required. Private open space is not required for each unit. However, if provided, it may be deducted from the total open space requirement. Each square foot of private open space and/or rooftop common open space shall be considered equivalent to two square feet of group open space and may be so substituted. Group usable open space shall have a minimum area of 300 square feet, and a rectangle inscribed within it shall have no dimension less than 15 feet. Required usable open space may be located at grade or as rooftop open space. Group open space areas shall not include parking or driveway areas, but may include setback areas provided it provides amenities and is integrated into the overall project design. R-3 Multiple-Family Residential Zone (Medium Density) and R-4 Multiple-Family Residential Zone (High Density): -Common open space shall be distributed throughout the development at convenient, safe, and easily accessible locations to all residents of the development. -Any one common open space area shall have minimum dimensions — depth or width — of 15 feet. -Common open space areas may be developed with landscaping, play equipment, swimming pools, walkways and paths, paved terraces, and similar features that benefit all residents of the development. -All common open spaces areas not covered by hard surface improvements as described in subparagraph 3, above, shall be landscaped.	Chapter 23.13 Building and Site Design Standards: 150 sf of the 300 sf must be provided as common open space. The balance of the required open space may be provided as private or common open space. Common open space includes but is not limited to courtyards, terraces, forecourts, gardens, outdoor dining areas, plazas, landscaped areas, patios, swimming pools, barbecue areas, athletic courts or fields, playgrounds, recreation areas, gardens, rooftop amenities, urban furniture, family friendly uses, shade structures, and other similar common areas intended for shared use by building occupants. Common open space also includes indoor activity and amenity space that is accessible and available to all building occupants.	R-3-13 Zone (Medium/High Density Residential Zone): Minimum width and length of open space shall be five feet for private spaces. R-3-20 and R-3-30 (High Density Residential Zones): Open spaces may be common or private.	
Common Open Space Standards		Chapter 23.13 Building and Site Design Standards: Common open space shall be located outside of front and street side setbacks.	R-3-13 Zone (Medium/High Density Residential Zone): Open space may be located on the ground floor or above, and may be met with a combination of common open space and private open space. R-3-20 and R-3-30 (High Density Residential Zones): 250 square feet per dwelling unit of on-site open space shall be provided on the ground level for use by residents. Driveways and other vehicular access areas shall not count toward the open space requirement. RHO (Religious Housing Overlay) Zone: Such open space may be located on the ground floor or above, and may be met with a combination of common open space and private open space. Driveways and other vehicular access areas shall not count toward the open space requirement.	
Location of Types of Open Spaces	Duarte Town Center Specific Plan: RESIDENTIAL OPEN SPACE REQUIRED Usable open space does not need to be located on the ground. Rooftop gardens and rooftop landscaping, including rooftops above parking structures, may be used to satisfy the open space requirement. The requirement for open space shall not be satisfied through the utilization of required setbacks, parking areas, driveways, or service areas. Areas designed to accommodate storm water retention may satisfy a portion of the requirement for open space if additional pedestrian amenities are provided near the space in a manner that provides for usability. Compliance with this requirement shall be evaluated by the Director in the review process.			
Rooftop Open Space				

Appendix E: SGVCOG Regional Objective Design Standards Research Memorandum

Exhibit A	Duarte	Alhambra	Sierra Madre
Dimension of Types of Open Space	<p>Duarte Station Specific Plan (Esperanza and Solana): Private usable open space located at ground level shall have a minimum area of 100 square feet and a rectangle inscribed within it shall have no dimension less than eight feet. The minimum area of above ground-level space shall be 50 square feet, and a rectangle inscribed within it shall have no dimension less than five feet. Private usable open space shall be adjacent to, and not more than four feet above or below the floor level of the dwelling unit served, or located on a rooftop with private access via the unit.</p> <p>Group usable open space shall have a minimum area of 300 square feet, and a rectangle inscribed within it shall have no dimension less than 15 feet. Required usable open space may be located at grade or as rooftop open space. Group open space areas shall not include parking or driveway areas, but may include setback areas provided it provides amenities and is integrated into the overall project design.</p>	<p>Chapter 23.13 Building and Site Design Standards: Common open space shall have a minimum dimension of 15 feet in all directions, except common indoor recreation/office uses.</p> <p>Private open space located on the ground level (e.g., yards, decks, patios) shall have no dimension less than eight feet. Private open space located above ground level (e.g., balconies) shall have no dimension less than five feet.</p>	<p>R-3-13 Zone (Medium/High Density Residential Zone): Minimum width and length of open space shall be ten feet for common spaces and five feet for private spaces.</p> <p>R-3-20 and R-3-30 (High Density Residential Zones): In order to be counted toward the open space requirement, the minimum width and length of each space shall be ten feet.</p> <p>RHO (Religious Housing Overlay) Zone: In order to be counted toward the open space requirement, the minimum width and length of each space shall be ten feet for common spaces and five feet for private spaces.</p>
Permitted Surface Types		<p>Chapter 23.13 Building and Site Design Standards: Outdoor common open space shall be surfaced in a manner that allows convenient use for outdoor living and/or recreation. Such surface may be any practicable combination of lawn, garden, flagstone, wood planking, concrete, decking, or other serviceable, dust-free surfacing.</p> <p>Private Open Space Surfacing: A surface shall be provided that allows convenient use for outdoor living and/or recreation. Such surface may be any practicable combination of lawn, garden, flagstone, wood planking, concrete, or other serviceable, dust-free surfacing. Slope shall not exceed 10%.</p>	
Exterior Lighting		<p>Alhambra MC 23.12.090 LIGHTING AND ILLUMINATION: (C) Minimum illumination: (1) Parking and access areas. Parking and access areas shall be maintained in compliance with § 23.20.090(J). (2) Major walkways. Major walkways shall be illuminated with an intensity of at least 0.25 foot-candles at the ground level during the hours of darkness. (3) Multi-unit residential buildings, aisles, passageways, and recesses related to and within the building complex shall be illuminated with an intensity of at least 0.25 foot-candles at the ground level during the hours of darkness. (4) Non-residential buildings. All exterior doors shall be illuminated with an intensity of at least 0.5 foot-candles at the ground level during the hours of darkness.</p>	
Lighting along Walkways	<p>Duarte Station Specific Plan (Esperanza and Solana): The type and location of exterior building lighting shall illuminate pedestrian pathways and preclude direct glare on to adjacent properties.</p>		
Driveways		<p>Chapter 23.20 Parking and Loading: (1) Parking areas designed to accommodate three or more vehicles shall be provided with a minimum of one foot-candle and a maximum of 3.0 foot-candles of light over the parking and access surface during the hours of use from one-half hour before dusk until one-half hour after dawn. (2) On-site lighting shall be installed along all vehicular access ways with a minimum of one foot-candle of light over the access way. (3) All lighting shall comply with the standards of § 23.12.090.</p>	
Parking Areas	<p>Duarte Station Specific Plan (Esperanza and Solana): Pedestrian scale lighting should be present at entries, plazas, courtyards, parking lots, and other areas where nighttime pedestrian activity is expected.</p> <p>Duarte Station Specific Plan (Esperanza and Solana): Lighting fixtures should advance the Duarte Station Specific Plan area design theme and provide cohesiveness throughout the Specific Plan area. Lighting design of fixtures and their structural support should be architecturally compatible with the architecture of the project.</p> <p>Duarte Town Center Specific Plan: Architecturally compatible lighting and fixtures should be incorporated that are complementary to the intended style/ theme.</p> <p>Light fixtures and poles shall be architecturally compatible with the building's architectural style.</p> <p>Color and finish of lighting metalwork, when used, should harmonize with building metalwork, if applicable.</p> <p>Architectural lighting should enhance a front building façade during twilight and night-time hours.</p> <p>Lighting accents should be incorporated into features such as doors, window openings, detail cornices, columns, or arcades to create texture and form unique to the building.</p> <p>Stone and brick building façades can benefit from a "close-in" lighting approach that grazes the light across the surface and calls attention to its textural quality by creating shadows.</p> <p>All fixtures and wiring should be wellhidden in the architectural details so that the lighting has a minimal impact during the day.</p> <p>Situations where a building façade is washed with bright light from a distant location are to be avoided. This approach "flattens" out the building's texture and causes unnecessary glare to the nighttime users.</p> <p>Light fixtures should be designed so that the light goes exactly where it is intended. Special care should be taken to include louvers, glare shields, or barn doors to the front of floodlight fixtures to prevent light pollution.</p> <p>Lighting fixtures should be mounted in strategic locations to facilitate maintenance.</p>	<p>West Main Corridor Master Plan: -introduce architectural lighting to enhance facades and accentuate key architectural features -provide architectural lighting at building entrances -select fixtures with the architectural design -complement the landscape/streetscape lighting -integrate lighting with signage, unobtrusive external illumination is recommended</p> <p>Alhambra MC 23.12.090 LIGHTING AND ILLUMINATION: (D) Maximum height. Light standards shall not exceed 20 feet in height and shall be appropriate in scale, intensity, and height to the use they are serving. (1) Exceptions. The Planning Commission may allow additional height for activities, uses, or development with unique lighting needs; for accentuating historic architectural features of a building, accentuating signage and/or landscape features; or for security purposes. (E) General requirements. (1) Fixture types. All luminaires shall meet the most recently adopted criteria of the Illuminating Engineering Society of North America (IESNA) for "cut off" or "full cut off" luminaires. (2) Design of fixtures. Fixtures shall be appropriate to the style and scale of the architecture. Fixtures on buildings shall be attached only to walls or eaves, and the top of the fixture shall not exceed the height of the parapet or roof or eave of roof. (3) Timing controls. All outdoor lighting in non-residential development shall be on a time clock or photo-sensor system and turned off during daylight hours and during hours when the building are not in use and the lighting is not required for security. (4) Trespass. All lights shall be directed, oriented, and shielded to prevent light trespass or glare onto adjacent properties. The light level at property lines shall not exceed 0.3 foot-candles.</p>	
Design of Lighting	<p>Architectural and landscape lighting is encouraged.</p> <p>Duarte Station Specific Plan (Esperanza and Solana): The type and location of exterior building lighting shall illuminate pedestrian pathways and preclude direct glare on to adjacent properties.</p> <p>Duarte Town Center Specific Plan: Fixtures shall not cast light directly into adjacent residential properties; a translucent or optical lens diffuser globe or shield is recommended.</p> <p>The intent of lighting a building is to enhance the best qualities of that building, not to become a "beacon"; therefore, light levels should be appropriate for the amount of illumination intended.</p> <p>Mixed Use Standards: Separation should be created within the site through vertical differences (e.g., grading, massing, roof heights, etc.)</p>	<p>West Main Corridor Master Plan: -minimize glare on adjacent properties and streets; interference with the safe operation of vehicles must be avoided</p> <p>Alhambra MC 23.12.090 LIGHTING AND ILLUMINATION: (D) Maximum height. Light standards shall not exceed 20 feet in height and shall be appropriate in scale, intensity, and height to the use they are serving. (1) Exceptions. The Planning Commission may allow additional height for activities, uses, or development with unique lighting needs; for accentuating historic architectural features of a building, accentuating signage and/or landscape features; or for security purposes. (E) General requirements. (4) Trespass. All lights shall be directed, oriented, and shielded to prevent light trespass or glare onto adjacent properties. The light level at property lines shall not exceed 0.3 foot-candles.</p>	<p>R-3-13 Zone (Medium/High Density Residential Zone): All lighting of the buildings, structures, landscaping, yards, parking areas, or similar facilities shall be in compliance with the city's "Dark Sky" objectives and policies. Lighting shall be shielded and directed downward to reflect away from adjoining properties.</p> <p>Commercial Zone: All lighting of the building, landscaping, parking lot or similar facilities shall be shielded and directed away from adjoining properties.</p>
Impact of Lighting on Neighboring Properties		<p>West Main Corridor Master Plan: -light outdoor spaces for enhanced comfort, safety, and security -allow subtle lighting that accentuates the landscape and highlights key landscape features -select fixtures that are compatible with their surroundings direct landscape lighting away from streets and adjacent properties -complement the architectural and streetscape lighting</p>	
Landscape Lighting	<p>Duarte Town Center Specific Plan: Architectural and landscape lighting is encouraged.</p> <p>Mixed Use Standards: Landscape features should be used to highlight individual uses.</p>		
Walls and Fencing			

Exhibit A	Duarte	Alhambra	Sierra Madre
Screening		<p>Alhambra MC 23.12.090 FENCES AND FREESTANDING WALLS: Fences, walls, dense hedges, and similar structures shall comply with the standards of this section. (A) Maximum height. The maximum allowed height of fences, walls, dense hedges, and related structures is as follows: (1) Front and street side yards. Fences, walls, dense hedges, and similar structures located within front and street side yards are subject to design review pursuant to Chapter 23.26 and the following. (a) Fences, walls, dense hedges, and similar structures may be a maximum of three feet high measured from finished grade when located within the front yard or within five feet of a street side property line. (b) In the event that there is a retaining wall, the maximum height of the fence or wall shall not exceed three feet, measured from the grade of the dirt for which the wall is retaining, but in no event shall the height of the retaining wall, together with the fence or wall, exceed six feet above sidewalk elevation. (c) The fence or wall shall not be constructed from grey smooth block unless architecturally treated (i.e. sand finish stucco, veneer, and the like), wire or chain link. (d) The fence or wall shall not contain any points, spikes, or ornamentation along its top. (e) The fence or wall shall be architecturally compatible with the design and style of the associated development. (2) Within 25 feet of a corner. Fences, walls, dense hedges, and similar structures located within 25 feet of an intersection shall comply with the standards of § 23.12.190. (3) Other areas. Fences, walls, dense hedges, and similar structures located on all other portions of a lot may be a maximum of six feet. The fence or wall shall not contain any points, spikes, or ornamentation along its top. (a) Exceptions. Fences, walls, dense hedges, and similar structures exceeding six feet in height to enclose commercial or industrial uses, tennis courts, or similar areas, when such fences are not in a street setback area, may be erected with approval of a minor use permit. (b) Prohibition on hazardous fencing materials. The use of barbed wire, razor wire, ultra-barrier, electrified, and other hazardous fencing is not permitted unless such fencing is required by any law or regulation of the city, the State of California, federal government, or other public agency. An exception to this standard may be approved for sites in an Industrial District, according to the procedures of Chapter 23.29. (c) Maintenance. All walls and fences shall be maintained in a safe, neat and orderly condition at all times. The finished side of all perimeter fencing shall face adjacent properties.</p>	<p>R-3-13 Zone (Medium/High Density Residential Zone) and RHO (Religious Housing Overlay) Zone: Parking areas, refuse storage, mechanical equipment and the like shall be screened by some combination of walls, plantings or earthworks.</p> <p>Commercial Zone: A plant screen shall be erected in place of a wall, provided it is: 1. Sufficient to visually screen the parking area; 2. Composed of specimen stock; 3. Within a planter area of at least four feet in depth; 4. Provided with a permanent irrigation system; 5. Compliant with all other provisions of this section for landscaping, including being an integral part of an approved landscaping plan.</p>
Wall and Fence Height		<p>Alhambra MC 23.12.090 FENCES AND FREESTANDING WALLS: Fences, walls, dense hedges, and similar structures shall comply with the standards of this section. (A) Maximum height. The maximum allowed height of fences, walls, dense hedges, and related structures is as follows: (1) Front and street side yards. Fences, walls, dense hedges, and similar structures located within front and street side yards are subject to design review pursuant to Chapter 23.26 and the following. (a) Fences, walls, dense hedges, and similar structures may be a maximum of three feet high measured from finished grade when located within the front yard or within five feet of a street side property line. (b) In the event that there is a retaining wall, the maximum height of the fence or wall shall not exceed three feet, measured from the grade of the dirt for which the wall is retaining, but in no event shall the height of the retaining wall, together with the fence or wall, exceed six feet above sidewalk elevation. (c) The fence or wall shall not be constructed from grey smooth block unless architecturally treated (i.e. sand finish stucco, veneer, and the like), wire or chain link. (d) The fence or wall shall not contain any points, spikes, or ornamentation along its top. (e) The fence or wall shall be architecturally compatible with the design and style of the associated development. (2) Within 25 feet of a corner. Fences, walls, dense hedges, and similar structures located within 25 feet of an intersection shall comply with the standards of § 23.12.190. (3) Other areas. Fences, walls, dense hedges, and similar structures located on all other portions of a lot may be a maximum of six feet. The fence or wall shall not contain any points, spikes, or ornamentation along its top. (a) Exceptions. Fences, walls, dense hedges, and similar structures exceeding six feet in height to enclose commercial or industrial uses, tennis courts, or similar areas, when such fences are not in a street setback area, may be erected with approval of a minor use permit.</p>	<p>Commercial Zone: B.A decorative masonry wall of at least thirty inches high may be substituted for a plant screen provided it is constructed and maintained along the perimeter of all off-street parking areas except at points of ingress and egress. Such wall shall be constructed of masonry units not greater than six inches in height. C.A landscaped area of at least thirty inches in height may be substituted for a wall or plant screen if the planning commission approves its design, location, scale and landscape treatment pursuant to a permit issued under the chapter. D.A decorative concrete, masonry or block wall of at least six feet in height shall be constructed and maintained on the boundary of any use which abuts or which lays across a public alley from a residential zone, except in front setbacks, in which such walls shall be forty-two inches or less in height.</p>
Design/Color/Material of Wall/Fencing		<p>Alhambra MC 23.12.090 FENCES AND FREESTANDING WALLS: Fences, walls, dense hedges, and similar structures shall comply with the standards of this section. (A) Maximum height. The maximum allowed height of fences, walls, dense hedges, and related structures is as follows: (1) Front and street side yards. Fences, walls, dense hedges, and similar structures located within front and street side yards are subject to design review pursuant to Chapter 23.26 and the following. (a) Fences, walls, dense hedges, and similar structures may be a maximum of three feet high measured from finished grade when located within the front yard or within five feet of a street side property line. (b) In the event that there is a retaining wall, the maximum height of the fence or wall shall not exceed three feet, measured from the grade of the dirt for which the wall is retaining, but in no event shall the height of the retaining wall, together with the fence or wall, exceed six feet above sidewalk elevation. (c) The fence or wall shall not be constructed from grey smooth block unless architecturally treated (i.e. sand finish stucco, veneer, and the like), wire or chain link. (d) The fence or wall shall not contain any points, spikes, or ornamentation along its top. (e) The fence or wall shall be architecturally compatible with the design and style of the associated development. (2) Within 25 feet of a corner. Fences, walls, dense hedges, and similar structures located within 25 feet of an intersection shall comply with the standards of § 23.12.190. (3) Other areas. Fences, walls, dense hedges, and similar structures located on all other portions of a lot may be a maximum of six feet. The fence or wall shall not contain any points, spikes, or ornamentation along its top. (a) Exceptions. Fences, walls, dense hedges, and similar structures exceeding six feet in height to enclose commercial or industrial uses, tennis courts, or similar areas, when such fences are not in a street setback area, may be erected with approval of a minor use permit. (b) Prohibition on hazardous fencing materials. The use of barbed wire, razor wire, ultra-barrier, electrified, and other hazardous fencing is not permitted unless such fencing is required by any law or regulation of the city, the State of California, federal government, or other public agency. An exception to this standard may be approved for sites in an Industrial District, according to the procedures of Chapter 23.29.</p>	
Location Walls/Fences Permitted		<p>Alhambra MC 23.12.090 FENCES AND FREESTANDING WALLS: Fences, walls, dense hedges, and similar structures shall comply with the standards of this section. (A) Maximum height. The maximum allowed height of fences, walls, dense hedges, and related structures is as follows: (1) Front and street side yards. Fences, walls, dense hedges, and similar structures located within front and street side yards are subject to design review pursuant to Chapter 23.26 and the following. (a) Fences, walls, dense hedges, and similar structures may be a maximum of three feet high measured from finished grade when located within the front yard or within five feet of a street side property line. (b) In the event that there is a retaining wall, the maximum height of the fence or wall shall not exceed three feet, measured from the grade of the dirt for which the wall is retaining, but in no event shall the height of the retaining wall, together with the fence or wall, exceed six feet above sidewalk elevation. (c) The fence or wall shall not be constructed from grey smooth block unless architecturally treated (i.e. sand finish stucco, veneer, and the like), wire or chain link. (d) The fence or wall shall not contain any points, spikes, or ornamentation along its top. (e) The fence or wall shall be architecturally compatible with the design and style of the associated development. (2) Within 25 feet of a corner. Fences, walls, dense hedges, and similar structures located within 25 feet of an intersection shall comply with the standards of § 23.12.190. (3) Other areas. Fences, walls, dense hedges, and similar structures located on all other portions of a lot may be a maximum of six feet. The fence or wall shall not contain any points, spikes, or ornamentation along its top. (a) Exceptions. Fences, walls, dense hedges, and similar structures exceeding six feet in height to enclose commercial or industrial uses, tennis courts, or similar areas, when such fences are not in a street setback area, may be erected with approval of a minor use permit.</p>	

Appendix E: SGVCOG Regional Objective Design Standards Research Memorandum

Exhibit A	Duarte	Alhambra	Sierra Madre
Noise and Buffering			
Design to Reduce Noise	Duarte Town Center Specific Plan: Mixed Use Standards: Noise-attenuating protection should be added for noise-sensitive uses and to provide privacy for residential areas.		
Buffering (landscaping) Buffering via Fence/Wall		West Main Corridor Master Plan: -buffer adjacent sensitive land uses through compatible landscape and/or architectural treatment.	
Loading Areas, Trash, and Utilities		Alhambra MC 23.20.080 LOADING: (A) Loading spaces required. Every new building, and every building enlarged by more than 10,000 square feet of gross floor area that is to be occupied by a non-residential use other than office uses shall provide one off-street loading space per 20,000 square feet of gross floor area. (1) Multi-tenant buildings. The gross floor area of the entire building shall be used in determining spaces for multi-tenant buildings. A common loading area may be provided, if each tenant space is not provided a loading area. (2) Reduction in number of loading spaces required. The loading space requirement may be reduced if the Director finds that the applicant has satisfactorily demonstrated that due to the nature of the proposed use and/or location, such loading space will not be needed or is not practical. (3) Additional loading spaces required. The required number of loading spaces may be increased to ensure that trucks will not be loaded, unloaded, or stored on public streets. Such requirement shall be based on the anticipated frequency of truck pickups and deliveries and of the truck storage requirements of the use for which the on-site loading spaces are required. West Main Corridor Master Plan: -locate service, loading, and storage areas so that they are not visible from the street Alhambra MC 23.20.080 LOADING: (B) Location. All required loading spaces shall be located immediately adjacent to the exterior wall of the building and a minimum of 25 feet from any Residential Zoning District or use. Loading areas shall not be located within the front or street side yard. (C) Minimum size. Each on-site loading space required by this chapter shall have an unobstructed minimum dimension of 12 feet in width, 40 feet in length, and 15 feet in height, exclusive of driveways for ingress and egress, maneuvering areas and setbacks. The minimum size requirement may be modified if the Director finds that the applicant has satisfactorily demonstrated that due to the nature of the proposed use, such size will not be needed. (D) Access. Loading spaces shall be designed and located such that trucks shall not be required to back into or from an arterial or collector street, or into or from an alley located within 50 feet of any an arterial or collector street. (E) Surfacing. All loading areas shall be surfaced with a minimum thickness of two inches of asphaltic concrete over a minimum thickness of four inches of a base material, to be approved by the Director of Public Works, or with a minimum thickness of four inches of Portland cement concrete. (F) Screening. Loading areas adjoining a street or required front yard, or located directly across an alley from a Residential Zoning District or use shall be screened with a solid wall or other method that is approved by the Director. Alhambra MC 23.12.120 REFUSE AND RECYCLING COLLECTION AREAS: This section establishes design and locational criteria for refuse, solid waste, recycling, compost, and green waste container storage areas. Refuse, solid waste, recycling, compost, and green waste are collectively referred to as "waste and recycling." (A) General requirements. All waste and recycling shall be placed in appropriate receptacles. All garbage cans, mobile trash bins, receptacles, and all recycling materials and containers for such recycling materials shall be maintained and stored in compliance with this section. (1) Space shall permit housing of required receptacles for separation of waste and recycling. (B) Containment. All development shall provide either individual waste and recycling containers or waste and recycling enclosures consistent with the following: (1) Individual waste and recycling containers. Individual waste and recycling containers for each unit or tenant may be provided as follows: (a) Development type. Individual waste and recycling containers may be provided for: 1. Single-unit development. 2. Multi-unit development with three or fewer units. 3. Non-residential development where the Director finds that the nature of the proposed development is such that the development will be adequately served with individual waste and recycling containers. (b) Location. The waste and recycling containers shall not be located within any of the following areas: 1. Required front or street side setback. 2. Required parking areas. 3. Required landscaped areas. 4. Any other area required by this title or any fire, building, or public safety code to be constructed or maintained unencumbered. (c) Visibility. The waste and recycling containers shall not be visible from a public right-of-way. (2) Waste and recycling container enclosures. Waste and recycling container enclosures are required for all new residential developments of four or more residential units and non-residential development except where the Director finds the development will be adequately served with individual waste and recycling containers pursuant to division (B)(1)(a) above. (a) Size. Waste and recycling-container enclosures shall be sized to accommodate all trash, garbage, recyclables, and green waste receptacles until such items are picked up by the city or its contracted waste and recycling collector. (b) Location. 1. The waste and recycling container enclosure shall be located within 100 feet of an access point to the building they serve for non-residential development and within 200 feet of an access point to the unit it serves for residential development. 2. The waste and recycling container enclosure shall not be located within any required front setback, street side setback, any required parking and landscaped areas, or any other area required by this title to be constructed or maintained unencumbered. (c) Accessibility. 1. Waste and recycling storage areas shall be accessible so that trucks and equipment used by the contracted waste and recycling collector have sufficient maneuvering areas and, if feasible, so that the collection equipment can avoid backing up. 2. For residential development with ten or more units, independent access shall be provided such that trash can be deposited without opening gates. (d) Screening. Waste and recycling storage areas located outside or on the exterior of any building shall be screened with a solid enclosure at least five feet high and include a roof structure. (e) Enclosure material. Enclosure material shall be solid masonry or concrete tilt-up with decorated exterior-surface finish. The trash enclosure shall match and complement the color scheme and architecture of the related development. (f) Gate material. Latching, view-obscuring gates shall be provided to screen trash enclosure openings.	
Commercial Loading Areas			
Screening Loading Areas	Duarte Station Specific Plan (Esperanza and Solana): All loading areas should be located at the rear or sides of buildings and screened from public view. For commercial buildings, where there is no alternative, loading may occur through the front door.	Commercial Zone: All loading or unloading areas containing a loading dock or similar facility shall be located at such a depth within a completely enclosed building as to reasonably contain and restrict noise. Further, no loading or unloading area shall be visible from a public street, or located within a front yard or side yard adjacent to a public street.	
Trash Enclosures Location	Duarte Town Center Specific Plan: All waste and recycling receptacles areas shall be screened from view from any public street and all adjacent properties, and screening shall be designed to be architecturally compatible and integral to the overall project design. R-3 Multiple-Family Residential Zone (Medium Density) and R-4 Multiple-Family Residential Zone (High Density): -Where common waste and recycling receptacles are provided, waste and recycling receptacles areas shall be designed and constructed in accordance with current standard City plans or policies. -Trash enclosures for individual units and/or common facilities should be sized to accommodate separate bins for recyclable trash and regular trash, as well as green/yard waste (when appropriate). -All waste and recycling receptacles areas shall be screened from view from any public street and all adjacent properties, and screening shall be designed to be architecturally compatible and integral to the overall project design. -All waste and recycling receptacles areas shall be located to be convenient, safe, and easily accessible to all residents of the development. City of Duarte Residential architectural and design standards (applies to all residential zones): Multifamily Standards: Architectural screening of trash and storage enclosures shall be constructed of materials and finishes compatible with the adjacent building, and shall be designed and placed to complement the style of development (see Figure 3-20). Recyclable materials and green waste storage areas shall be conveniently located adjacent to solid waste disposal areas, or near one another, or combined. They may only be located inside a specially designated structure, on the outside of a structure in an approved fence or wall enclosure, a designated interior court or yard area with appropriate access, or in rear or interior side yards. Exterior storage areas shall not be located in a required front yard, street side yard, parking space, landscaped area, or open space areas.		

Exhibit A	Duarte	Alhambra	Sierra Madre	
	Duarte Station Specific Plan (Esperanza and Solana): Roof-top mechanical equipment shall be screened from the street level view and appear as integrated building forms both in shape and material. Service areas should be located within the envelope of the building as much as is practical and should not be visible from public streets and spaces. If service areas are not within the building envelope and cannot be located away from the street front, they should be screened from street level views, including from above. The material, scale, and forms of screening used should complement the design of the main building. Buildings shall have a direct door from the interior to the service area(s) so that occupants can access such areas without passing through the public right-of-way. Roof-top-mounted mechanical equipment shall be located away from the street edge and screened from ground-level view behind parapets. Where screening methods other than parapets are used, they should be an integral component of the architectural design or a complimentary accent feature to that design. Attached equipment such as antennas, satellite dishes, etc. should be screened from ground level view or integrated into the building design. Ground-level mechanical equipment shall be located away from and screened from view from public areas by walls that complement the building architecture or by landscaping. Exceptions may be made for fire-fighting equipment. City of Duarte Residential architectural and design standards (applies to all residential zones): Roof-mounted equipment, where permitted, shall be screened from view from public rights-of-way and adjacent properties by materials that are architecturally compatible with the structure they serve. Mechanical equipment on the ground or on the roof should be screened from view from adjacent properties and the public right-of-way by an enclosure designed as part of the building or by appropriate landscaping (see Figure 3-19). Water heaters, electrical boxes, gas meters, landscape irrigation equipment, and similar utility boxes should be painted to match the structure or be appropriately screened from view, or should be integrated into the floor plan of the structure. Where feasible, appurtenant equipment, plumbing, and related solar energy fixtures shall be installed in the attic, or if infeasible, flush mounted or ground mounted. Appurtenant equipment, plumbing, and related solar energy fixtures shall comply with the setback requirements of Section 19.32.020 (Permitted Projections into Required Setback Areas) and shall be screened from public view. City of Duarte Residential architectural and design standards (applies to all residential zones): Multifamily Standards: Storage areas shall be completely screened from ground level view using appropriate materials and shall be designed for maximum security. See development standards for storage areas in Section 19.10.050 (R-3 and R-4 Zones: Additional Standards).	West Main Corridor Master Plan: -locate and/or screen rooftop equipment so that it is not visible from the street -make rooftop screening integral to the building's form Alhambra MC 23.12.130 SCREENING: (B) Required screening. (1) Roof-mounted equipment and duct systems. All roof-mounted equipment shall be screened according to the following standards: (a) Flat roof, partial or no parapet. Roof-mounted equipment or ducts located on a flat roof (partial or no parapet) shall be screened from view from any street, public right-of-way or adjacent property. The screening shall be solid, and shall match and complement the color scheme and architecture of the building. (b) Pitched roof. For roof-mounted equipment or ducts located on a pitched roof, the parapet roof shall be designed and constructed to accommodate roof-mounted equipment. A platform shall be constructed and recessed into the roof such that one side of the equipment shall be below the pitch of the roof. The remainder of the equipment and ducts which are above the roof pitch shall be screened from view from any street, public right-of-way or adjacent property. The screening shall be solid, and shall match and complement the color scheme and architecture of the building or roof. (c) Parapet roof. For roof-mounted equipment or ducts located on a parapet roof, the parapet roof shall be designed and constructed to accommodate roof-mounted equipment. Any portion of the equipment or ducts which are above the parapet shall be screened from view from any street, public right-of-way or adjacent property. The screening shall be solid, and shall match and complement the color scheme and architecture of the building. (2) Ground- or wall-mounted equipment. All exterior mechanical and electrical equipment shall be screened, flush mounted, or incorporated into the design of buildings so as not to be visible from public rights-of-way. Equipment to be screened includes, but is not limited to, air conditioners, heaters, pool equipment, utility meters, cable equipment, telephone entry boxes, backflow preventions, irrigation control valves, electrical transformers, pull boxes, and all ducting for air conditioning, heating, and blower systems. Screening materials shall be consistent with the exterior colors and materials of the building. Exceptions may be granted by the Director where screening is infeasible due to health and safety or utility requirements.	Commercial Zone: All storage of wares, merchandise, crates, bottles or similar items shall be within a completely enclosed building. All ground mechanical equipment shall be completely screened behind a permanent structure and all roof top mechanical equipment shall be completely screened from view from street level. R-3-13 Zone (Medium/High Density Residential Zone): Parking areas, refuse storage, mechanical equipment and the like shall be screened by some combination of walls, plantings or earthworks. RHO (Religious Housing Overlay) Zone: All utilities shall be placed underground.	
Utility Location				
Parking Structures				
Massing of Parking				
Height of Parking			R-3-13 Zone (Medium/High Density Residential Zone): Structures used principally for parking shall not be higher than one story. Parking shall not be permitted above ground level.	

Appendix E: SGVCOG Regional Objective Design Standards Research Memorandum

Exhibit A	Duarte	Alhambra	Sierra Madre
	<p>Duarte Station Specific Plan (Esperanza and Solana): Highland Frontage: From Pedestrian and Streetscape Activity Zone: Minimum: 0' Maximum: 10'</p> <p>Secondary Frontage: From property line: Minimum: 10' Maximum: 20'</p> <p>Rail Frontage (primary): From property line: Minimum: 20'</p> <p>Rail Frontage (secondary): From property line: Minimum: 15'</p> <p>Internal Frontage: From back of sidewalk: Minimum: 10'</p> <p>Neighborhood Frontage: From back of sidewalk: Minimum: 10'</p> <p>Paseo Frontage: None</p> <p>Setback Projections (all frontage types except paseo frontage): Ground-floor porches, stairs, bay windows, and awnings may encroach up to 5' into minimum required setbacks. Upper story balconies, bay windows, and awnings may encroach up to 3' into minimum required setbacks. Trash enclosures may be located in the setback as long as they meet requirements in the design guidelines. Outdoor dining and open space amenities are encouraged; site plan review and approval required by the Community Development Director or designee.</p> <p>Setback Projections (only paseo frontage): No building encroachments permitted. Open space amenities allowed.</p> <p>Duarte Town Center Specific Plan: Front Setback - Ground Floor Commercial Use: No min, 5 ft max Ground Floor Residential Use: 10 ft min</p> <p>Side Setback - Ground Floor Commercial Use: None Ground Floor Residential Use: 5 ft min</p> <p>Rear Setback - Ground Floor Commercial Use: None Ground Floor Residential Use: 15 ft min</p> <p>Key Intersection Maximum 18-inch Setback Requirement Where a key intersection is identified in this Plan, the setback of each new corner building or addition to existing corner buildings shall be no more than 18 inches from the adjoining property line. The key intersection setback is required for the first 100 feet of building frontage along both intersecting streets. Key Intersections are identified as any property located at any corner intersection of the following streets: • Buena Vista Street and Huntington Drive • Highland Avenue and Huntington Drive</p> <p>Commercial Front Setback and Key Intersection Setback Exceptions 1. Building Plan Interruptions Exception. To allow for the inclusion of recessed entries, breaks in the building plane, passages to courtyards, and other similar breaks in the street wall, up to 30% of the length of a facade and/or front building plane may be interrupted or set back from the maximum setback requirement to accommodate recessed entries, breaks in building plane, passages to courtyards, and other similar breaks in the street wall. 2. Outdoor Dining Exception. Where a building has a ground-floor commercial use, a maximum setback exception may be permitted of up to 20 feet for outdoor cafes and small plazas. 3. Plaza Exception. At any Key Intersection, no maximum setback is required if a large quasispublic plaza space is constructed with direct access and frontage on Huntington Drive.</p> <p>ARCHITECTURAL FEATURES PROJECTIONS INTO SETBACKS Lobbies, porches, stoops, and other entry-related architectural features may extend up to four feet into the required front setback area. Upper-floor balconies may extend up to two feet into the setback area; up to three feet may be considered depending on design and Director approval. Where an upper-story setback is required pursuant to Section 3.6.4 and/or 3.6.5, upper-floor balconies may extend up to two feet into the required setback; up to three feet may be considered or up to five feet for rear setbacks depending on design and Director approval.</p> <p>Utilize building setbacks and arcaded spaces as an extension of the sidewalk to provide adequate space for pedestrian movement and activity. This space can be used for outdoor seating, street furniture, landscaping, and public art that can enliven the streetscape.</p> <p>R-2 Two-Family Residential Zone (Medium Density): Front: 20 ft Side interior: 5 ft Side corner: 10 ft Side reverse corner: 15 ft Rear single story: 10 ft Rear second story: 20 ft Abutting an alley: 25 ft</p> <p>R-3 Multiple-Family Residential Zone (Medium Density): Front setback: 30 ft Side interior: 5 ft Side corner: 10 ft Side reverse corner: 15 ft Rear abutting R-1 zone: 25 ft Rear all other zones: 20 ft</p> <p>R-4 Multiple-Family Residential Zone (High Density): Front setback: 30 ft Side interior: 5 ft Side corner: 10 ft Side reverse corner: 15 ft Rear abutting R-1 zone: 25 ft Rear all other zones: 20 ft</p>	<p>RM (Residential Medium) Zone: Min front setback: Average of front setbacks of two adjacent properties or 20 ft, whichever is greater</p> <p>Minimum street side setback (feet): 10</p> <p>Reverse corner lot setback (feet): The required front setback of the first lot to the rear</p> <p>Minimum interior setback (feet) first story: 5</p> <p>Minimum rear setback (feet): 10</p> <p>Minimum distance between buildings (feet measured from eave to eave) (feet): 5</p> <p>Through lots. In the case of through lots, both street frontages shall be designated as front yards and shall comply with all regulations pertaining thereto, including setbacks, projections, location of parking spaces and open space.</p> <p>RH (Residential High) Zone: Min front setback: Properties on Curtis or Electric Lanes: 15 Other areas: Average of front setbacks of two adjacent properties or 15 ft, whichever is greater</p> <p>Minimum street side setback (feet): 10</p> <p>Reverse corner lot setback (feet): The required front setback of the first lot to the rear</p> <p>Minimum interior setback (feet) first story: 5</p> <p>Minimum rear setback (feet): Properties which have rear yards on Curtis or Electric Lanes: 15 feet, otherwise 10 feet</p> <p>Minimum distance between buildings (feet measured from eave to eave) (feet): 5</p> <p>Through lots. In the case of through lots, both street frontages shall be designated as front yards and shall comply with all regulations pertaining thereto, including setbacks, projections, location of parking spaces and open space.</p> <p>Central Business District (CBD) Zone: front setback: none street side setback: none interior side setback (feet): 0, 10 adjacent to a Residential Zoning District Rear setback (feet): 0, 10 adjacent to a Residential Zoning District Minimum Distance between buildings (feet measured from eave to eave): 5</p> <p>East Main Commercial (EMC) Zone: front setback: none street side setback: none interior side setback (feet): 0, 10 adjacent to a Residential Zoning District Rear setback (feet): 0, 10 adjacent to a Residential Zoning District Minimum Distance between buildings (feet measured from eave to eave): 5</p> <p>Commercial Mixed-Use (CMU) Zone: front setback: none street side setback: none interior side setback (feet): 0, 10 adjacent to a Residential Zoning District Rear setback (feet): 0, 10 adjacent to a Residential Zoning District Minimum Distance between buildings (feet measured from eave to eave): 5</p> <p>Professional Office (PO) Zone: front setback (feet): 20 street side setback (feet): 10 side setback (feet): 5 Rear setback (feet): 10 Minimum Distance between buildings (feet measured from eave to eave): 5</p> <p>Industrial (I) Zone: front setback (feet): 10 street side setback (feet): 10 side setback (feet): 0, 10 adjacent to a Residential Zoning District Rear setback (feet): 0, 10 adjacent to a Residential Zoning District Minimum Distance between buildings (feet measured from eave to eave): 5</p>	<p>R-3-13 Zone (Medium/High Density Residential Zone): Front Ground Floor: 15 feet</p> <p>Rear: 10 feet</p> <p>Side or Rear (next to R-1 zoned sites) for buildings above one story: 10 feet for height below 20 feet, plus use of "angle-plane" Angle-plane: For yards abutting an R-1 zoned lot, an encroachment limit shall be established which is determined at a point twenty feet above the existing ground level at the setback line as required by subsection D above, and using a forty-five-degree angle inwards toward the property to create additional setback.</p> <p>Side (next to an alley or lots zoned other than R-1) for main/accessory buildings: 10% of lot width, 5 minimum, 15 maximum.</p> <p>Side (next to a public street) for main/accessory buildings: 10% of lot width, 10 minimum, 15 maximum.</p> <p>Side (next to an alley) for garages opening to alley: 25 feet from opposite side of alley</p> <p>R-3-30 (High Density Residential Zone): In the R-3-30 zone only, the minimum front yard setback for the first and second floors shall be fifteen feet.</p> <p>Commercial Zone: A. Front Yard. There shall be a front yard having a minimum depth of five feet extending across the full width of the lot. B. Side Yard. Side yards adjacent to a street or alley shall be not less than ten feet in width. C. Rear Yard. There shall be a rear yard of not less than fifteen feet in width; however, a maximum of ten feet of said rear yard may be used for off-street parking. D. Yards Adjacent to Residential Zones. If either the side or rear yards are adjacent to any residential zone or use, a minimum of ten feet of the required yards shall be landscaped with specimen plants and trees (minimum fifteen gallon stock) to create a solid plant screen as represented on a landscaping plan approved by the director.</p> <p>RHO (Religious Housing Overlay) Zone: The minimum front setback shall be fifteen feet for all floors of the building, except along Michillinda Avenue and Baldwin Avenue, where the minimum front setback shall be five feet.</p> <p>Rear: 10 feet</p> <p>Side or Rear (next to R-1 zoned sites) for buildings above one story: 10 feet for height below 20 feet, plus use of "angle-plane" Angle-plane: For yards abutting an R-1 zoned lot, an encroachment limit shall be established which is determined at a point twenty feet above the existing ground level at the setback line as required by subsection D above, and using a forty-five-degree angle inwards toward the property to create additional setback.</p> <p>Side (next to an alley or lots zoned other than R-1) for main/accessory buildings: 10% of lot width, 5 minimum, 15 maximum.</p> <p>Side (next to a public street) for main/accessory buildings: 10% of lot width, 10 minimum, 15 maximum.</p> <p>Side (next to an alley) for garages opening to alley: 25 feet from opposite side of alley</p> <p>Angle-plane: For yards abutting an R-1 zoned lot, an encroachment limit shall be established which is determined at a point twenty feet above the existing ground level at the setback line as required by subsection D above, and using a forty-five-degree angle inwards toward the property to create additional setback.</p>
Stepbacks	<p>Duarte Town Center Specific Plan: REQUIRED UPPER-STORY STEPBACK: PUBLIC STREET</p> <p>Buildings taller than three stories fronting on public streets shall include building height modulation to reduce building scale at the street edge. Any and all stories above the third story shall maintain an average setback of at least 12 feet from the front property line. The required upper story setback shall create usable outdoor space, such as a rooftop garden or similar amenity.</p> <p>The Community Development Director/Designee is authorized to allow a reduction through the modification process of the required upper story setback by no more than five feet subject to the following: 1. Offset. Each square foot of additional building area proposed within the setback is offset with an additional square foot of public or quasispublic open space (excluding area required for sidewalk dedication or easement) at the street level. 2. Location. The public/quasi-public open space is located along the sidewalk frontage and is not covered by buildings. 3. Design. The design and location is consistent with applicable design guidelines.</p> <p>SIDE/REAR STEP-BACK RELATION TO SINGLE FAMILY RESIDENTIAL (R-1) ZONE A relational height limit to properties located next to the Single Family Residential (R-1) Zone is established to create an appropriate height relationship where new development is adjacent to an existing R-1 Zone. This limit is applied to new development on any parcels that abut another parcel with a R-1 Zone designation. Where a building is adjacent to an existing R-1 Zoned parcel along its side and/or rear property lines, the first two stories of a structure shall be set back a minimum of 10 feet from the side and/or rear property line. The building shall step back a minimum of 30 feet from the adjacent side and/or rear property line for the third story and any story above.</p> <p>Activate upper-story stepback areas with balconies or roof gardens.</p> <p>R-2 Two-Family Residential Zone (Medium Density): In all R-1 and R-2 zones, where the side or rear yard setback for the first story is the minimum required setback for the applicable zone, the second story of any residential structure shall be set back an additional two and one-half feet from the required minimum setback (see Figure 2-2). If the first story is set back 30 inches or more than the minimum required setback, no additional setback of the second story shall be required.</p> <p>R-3 Multiple-Family Residential Zone (Medium Density): For structures with more than one story in the R-3 and R-4 zones, the rear setback shall be increased by five feet for each story or fractional story above the first story.</p> <p>R-4 Multiple-Family Residential Zone (High Density): For structures with more than one story in the R-3 and R-4 zones, the rear setback shall be increased by five feet for each story or fractional story above the first story.</p>	<p>RM (Residential Medium) Zone: Minimum interior setback (feet) upper stories: 6</p> <p>RH (Residential High) Zone: Minimum interior setback (feet) upper stories: 6</p> <p>Chapter 23.13 Building and Site Design Standards: In addition to the facade articulation requirement in division B(3)(b)1, above, upper and lower stories in buildings of three or more stories shall be distinguished by incorporating one or more of the following features. These features may be applied to the transitions between any floors, except where otherwise specified. c. Setting back the top floor or floors of the building at least five feet from the remainder of the facade.</p> <p>West Main Corridor Master Plan: upper floor setbacks are encouraged -respond to adjacent residential use with a sensitive transition in scale and massing; a step back in building height or break in massing is appropriate.</p> <p>Central Business District (CBD) Zone, East Main Commercial (EMC) Zone, and Commercial Mixed-Use (CMU) Zone: Buildings shall be located within ten feet of street-facing property lines for at least 50% of the linear street frontage.</p> <p>Modifications. These requirements may be modified or waived through approval of a modification upon finding that: 1. Entry courtyards, plazas, entries, or outdoor eating areas are located adjacent to the property line and buildings are built to the edge of the courtyard, plaza, or dining area; or 2. The building incorporates an alternative entrance design that creates a welcoming entry feature facing the street or is designed in a manner that complements adjacent or surrounding land uses.</p>	<p>R-3-13 Zone (Medium/High Density Residential Zone): Front Second Floor: 25 feet</p>
Build to Line			
Building Coverage		<p>RM (Residential Medium) Zone: Max lot coverage: 45%</p> <p>RH (Residential High) Zone: Max lot coverage: 55%</p>	<p>R-3-13 Zone (Medium/High Density Residential Zone): Building coverage shall not exceed an aggregate of 45% of the lot area. Covered area shall be considered to be the total amount of land covered by residential structures, garages, driveways, and other impermeable surfaces. Decks, permeable patios, porous paving areas, vegetated roof areas, recreational areas, pedestrian walkways and terraces shall not be considered covered area for the purpose of this standard. An additional 15% in covered area may be added to the aggregate, increasing it to 60% with the use of porous surfaces and/or vegetated roof areas.</p> <p>Commercial Zone: Coverage of any parcel by roofed structures shall not exceed eighty percent, exclusive of all existing or required streets, sidewalks and alleys.</p>

Setbacks

Exhibit A	Duarte	Alhambra	Sierra Madre
	<p>Duarte Town Center Specific Plan: REQUIRED UPPER-STORY STEPBACK: PUBLIC STREET</p> <p>Buildings taller than three stories fronting on public streets shall include building height modulation to reduce building scale at the street edge. Any and all stories above the third story shall maintain an average setback of at least 12 feet from the front property line. The required upper story setback shall create usable outdoor space, such as a rooftop garden or similar amenity.</p> <p>The Community Development Director/Designee is authorized to allow a reduction through the modification process of the required upper story setback by no more than five feet subject to the following: 1. Offset. Each square foot of additional building area proposed within the setback is offset with an additional square foot of public or quasispublic open space (excluding area required for sidewalk dedication or easement) at the street level. 2. Location. The public/quasi-public open space is located along the sidewalk frontage and is not covered by buildings. 3. Design. The design and location is consistent with applicable design guidelines.</p> <p>SIDE/REAR STEP-BACK RELATION TO SINGLE FAMILY RESIDENTIAL (R-1) ZONE A relational height limit to properties located next to the Single Family Residential (R-1) Zone is established to create an appropriate height relationship where new development is adjacent to an existing R-1 Zone. This limit is applied to new development on any parcels that abut another parcel with a R-1 Zone designation. Where a building is adjacent to an existing R-1 Zoned parcel along its side and/or rear property lines, the first two stories of a structure shall be set back a minimum of 10 feet from the side and/or rear property line. The building shall step back a minimum of 30 feet from the adjacent side and/or rear property line for the third story and any story above.</p> <p>Activate upper-story stepback areas with balconies or roof gardens.</p> <p>R-2 Two-Family Residential Zone (Medium Density): In all R-1 and R-2 zones, where the side or rear yard setback for the first story is the minimum required setback for the applicable zone, the second story of any residential structure shall be set back an additional two and one-half feet from the required minimum setback (see Figure 2-2). If the first story is set back 30 inches or more than the minimum required setback, no additional setback of the second story shall be required.</p> <p>R-3 Multiple-Family Residential Zone (Medium Density): For structures with more than one story in the R-3 and R-4 zones, the rear setback shall be increased by five feet for each story or fractional story above the first story.</p> <p>R-4 Multiple-Family Residential Zone (High Density): For structures with more than one story in the R-3 and R-4 zones, the rear setback shall be increased by five feet for each story or fractional story above the first story.</p>	<p>RM (Residential Medium) Zone: Minimum interior setback (feet) upper stories: 6</p> <p>RH (Residential High) Zone: Minimum interior setback (feet) upper stories: 6</p> <p>Chapter 23.13 Building and Site Design Standards: In addition to the facade articulation requirement in division B(3)(b)1, above, upper and lower stories in buildings of three or more stories shall be distinguished by incorporating one or more of the following features. These features may be applied to the transitions between any floors, except where otherwise specified. c. Setting back the top floor or floors of the building at least five feet from the remainder of the facade.</p> <p>West Main Corridor Master Plan: upper floor setbacks are encouraged -respond to adjacent residential use with a sensitive transition in scale and massing; a step back in building height or break in massing is appropriate.</p> <p>Central Business District (CBD) Zone, East Main Commercial (EMC) Zone, and Commercial Mixed-Use (CMU) Zone: Buildings shall be located within ten feet of street-facing property lines for at least 50% of the linear street frontage.</p> <p>Modifications. These requirements may be modified or waived through approval of a modification upon finding that: 1. Entry courtyards, plazas, entries, or outdoor eating areas are located adjacent to the property line and buildings are built to the edge of the courtyard, plaza, or dining area; or 2. The building incorporates an alternative entrance design that creates a welcoming entry feature facing the street or is designed in a manner that complements adjacent or surrounding land uses.</p>	<p>R-3-13 Zone (Medium/High Density Residential Zone): Front Second Floor: 25 feet</p>
Stepbacks	<p>Duarte Town Center Specific Plan: REQUIRED UPPER-STORY STEPBACK: PUBLIC STREET</p> <p>Buildings taller than three stories fronting on public streets shall include building height modulation to reduce building scale at the street edge. Any and all stories above the third story shall maintain an average setback of at least 12 feet from the front property line. The required upper story setback shall create usable outdoor space, such as a rooftop garden or similar amenity.</p> <p>The Community Development Director/Designee is authorized to allow a reduction through the modification process of the required upper story setback by no more than five feet subject to the following: 1. Offset. Each square foot of additional building area proposed within the setback is offset with an additional square foot of public or quasispublic open space (excluding area required for sidewalk dedication or easement) at the street level. 2. Location. The public/quasi-public open space is located along the sidewalk frontage and is not covered by buildings. 3. Design. The design and location is consistent with applicable design guidelines.</p> <p>SIDE/REAR STEP-BACK RELATION TO SINGLE FAMILY RESIDENTIAL (R-1) ZONE A relational height limit to properties located next to the Single Family Residential (R-1) Zone is established to create an appropriate height relationship where new development is adjacent to an existing R-1 Zone. This limit is applied to new development on any parcels that abut another parcel with a R-1 Zone designation. Where a building is adjacent to an existing R-1 Zoned parcel along its side and/or rear property lines, the first two stories of a structure shall be set back a minimum of 10 feet from the side and/or rear property line. The building shall step back a minimum of 30 feet from the adjacent side and/or rear property line for the third story and any story above.</p> <p>Activate upper-story stepback areas with balconies or roof gardens.</p> <p>R-2 Two-Family Residential Zone (Medium Density): In all R-1 and R-2 zones, where the side or rear yard setback for the first story is the minimum required setback for the applicable zone, the second story of any residential structure shall be set back an additional two and one-half feet from the required minimum setback (see Figure 2-2). If the first story is set back 30 inches or more than the minimum required setback, no additional setback of the second story shall be required.</p> <p>R-3 Multiple-Family Residential Zone (Medium Density): For structures with more than one story in the R-3 and R-4 zones, the rear setback shall be increased by five feet for each story or fractional story above the first story.</p> <p>R-4 Multiple-Family Residential Zone (High Density): For structures with more than one story in the R-3 and R-4 zones, the rear setback shall be increased by five feet for each story or fractional story above the first story.</p>	<p>RM (Residential Medium) Zone: Minimum interior setback (feet) upper stories: 6</p> <p>RH (Residential High) Zone: Minimum interior setback (feet) upper stories: 6</p> <p>Chapter 23.13 Building and Site Design Standards: In addition to the facade articulation requirement in division B(3)(b)1, above, upper and lower stories in buildings of three or more stories shall be distinguished by incorporating one or more of the following features. These features may be applied to the transitions between any floors, except where otherwise specified. c. Setting back the top floor or floors of the building at least five feet from the remainder of the facade.</p> <p>West Main Corridor Master Plan: upper floor setbacks are encouraged -respond to adjacent residential use with a sensitive transition in scale and massing; a step back in building height or break in massing is appropriate.</p> <p>Central Business District (CBD) Zone, East Main Commercial (EMC) Zone, and Commercial Mixed-Use (CMU) Zone: Buildings shall be located within ten feet of street-facing property lines for at least 50% of the linear street frontage.</p> <p>Modifications. These requirements may be modified or waived through approval of a modification upon finding that: 1. Entry courtyards, plazas, entries, or outdoor eating areas are located adjacent to the property line and buildings are built to the edge of the courtyard, plaza, or dining area; or 2. The building incorporates an alternative entrance design that creates a welcoming entry feature facing the street or is designed in a manner that complements adjacent or surrounding land uses.</p>	<p>R-3-13 Zone (Medium/High Density Residential Zone): Front Second Floor: 25 feet</p>
Build to Line			
Building Coverage		<p>RM (Residential Medium) Zone: Max lot coverage: 45%</p> <p>RH (Residential High) Zone: Max lot coverage: 55%</p>	<p>R-3-13 Zone (Medium/High Density Residential Zone): Building coverage shall not exceed an aggregate of 45% of the lot area. Covered area shall be considered to be the total amount of land covered by residential structures, garages, driveways, and other impermeable surfaces. Decks, permeable patios, porous paving areas, vegetated roof areas, recreational areas, pedestrian walkways and terraces shall not be considered covered area for the purpose of this standard. An additional 15% in covered area may be added to the aggregate, increasing it to 60% with the use of porous surfaces and/or vegetated roof areas.</p> <p>Commercial Zone: Coverage of any parcel by roofed structures shall not exceed eighty percent, exclusive of all existing or required streets, sidewalks and alleys.</p>

Appendix E: SGVCOG Regional Objective Design Standards Research Memorandum

Exhibit A	Duarte	Alhambra	Sierra Madre
		<p>Central Business District (CBD) Zone, East Main Commercial (EMC) Zone, and Commercial Mixed-Use (CMU) Zone: Frontage improvements. The area between buildings and the property line shall be improved as part of a wider sidewalk, outdoor dining/seating area, or with landscaping.</p> <p>Alhambra MC CHAPTER 23.17 LANDSCAPING: 23.17.020 APPLICABILITY. The provisions of this chapter shall apply to the following: (A) All new development. (B) Additions to single-unit dwelling residential developments that expand existing floor area by 50% or more. (C) Additions to multi-unit dwelling residential developments and non-residential development that expand existing floor area by 10% or more. (D) All new and rehabilitated landscaping projects that include new irrigated landscaping over 2,500 square feet.</p> <p>23.17.030 AREAS TO BE LANDSCAPED. In addition to areas required to be landscaped pursuant to other sections of this title, the following areas shall be landscaped, and, where located on-site, may count toward the total area of a site required to be landscaped. All landscaping shall comply with the requirements of § 23.17.050. (A) Street-facing yards. All street-facing yards shall be landscaped with live plants pursuant to § 23.17.050(A), except as follows: (1) Hardscape areas. (a) Residential. 1. Up to 25% of the yard area may be covered by non-decorative hardscape features (e.g., concrete, asphalt, gravel, driveways, sidewalks, etc.) 2. Up to 25% of the yard area may be covered by decorative permeable hardscape features (e.g., brick, stone, mulch, water feature, etc.) (b) Non-residential. Up to 75% of the yard area may be covered by hardscape features (e.g., concrete, asphalt, gravel, driveways, sidewalks, etc.) (2) Through lots. Rear yards of through lots that are located behind a solid wall or fence five feet or higher in height approved through the modification process are not required to be landscaped. (B) Sloped areas. All areas with 3:1 or greater slope. (C) Parkways. Live plant materials shall be the primary materials used. No more than 25% of the parkway area shall be covered by non-decorative hardscape features (e.g., concrete, asphalt, gravel, sidewalks, etc.) No more than 25% may be covered by decorative permeable hardscape features (e.g., brick, mulch, etc.). The remaining 50% of the parkway area must be of live plant material which shall not exceed 36 inches in height and an automatic irrigation system shall be required for the parkway area(s). Loose decorative stone and sharp or thorned plant material are discouraged. Artificial turf is not allowed in parkways. All parkway tree species should be in accordance with the city's Street Tree Planting Plan. (1) Landscaped parkways abutting streets must be maintained by the property owner in such a way as to keep all plant life alive, thriving and displaying its natural colors and shall be properly trimmed and cut. (D) Building perimeters. The portions of a non-residential building that front a public street shall have one or more landscape planters installed along a minimum 20% of that building face. The minimum width of the planter shall be three feet. This standard does not apply where a building is located on the front or street side property line. (E) Parking areas. Parking areas as required by Chapter 23.20. (F) Unused areas. All areas of a project site not intended for a specific use, including areas planned for future phases of a phased development, shall be landscaped, hydrosedded, or left in a natural state.</p> <p>23.17.050 GENERAL REQUIREMENTS. (A) Materials. (1) General. (a) Required landscaped areas shall be planted with a combination of ground covers, shrubs, vines, and trees. A minimum of one different plant type per 1,000 square feet of lot area shall be provided, up to a maximum of ten different plant types. (2) Required water efficient plants. One of the following options of types of plants shall be chosen to ensure that the landscape project meets water efficiency requirements. (a) Option A: all low water plants. Exclusive of garden areas dedicated to edible plants, all plants and trees shall be low or very low water use (average California Department of Water Resources study, Water Use Classification of Landscape Species (WUCOLS) plant factor of 0.3). Option A is available for all residential and non-residential areas. (b) Option B: primarily low water plants. Exclusive of garden areas dedicated to edible plants, at least 75% of the landscape area shall contain low or very low water use plants (average WUCOLS plant factor of 0.3). Option B is only available for residential areas. (c) Option C: water use calculation. The estimated total water use (ETWL) of the landscaping shall not exceed the maximum applied water allowance (MAWA), calculated pursuant to the State Model Water Efficient Landscape Ordinance (MWELO). Option C is available for all residential and non-residential areas. 1. Department of Water Resources Model Water Efficient Landscape Ordinance compliance required. Where Option C: water use calculation is selected, all requirements of the Department of Water Resources Model Water Efficient Landscape Ordinance shall apply. (3) Size and spacing. Plant materials shall be grouped in hydrozones in accordance with their respective water, cultural (soil, climate, sun and light), and maintenance needs. Plants shall be of the following size and spacing at the time of installation: (a) Ground covers. Ground cover plants other than grasses shall be at least the four-inch pot size. Areas planted in ground cover plants other than grass seed or sod must be planted at a rate of one per 12 inches on center. (b) Shrubs. Shrubs shall be a minimum size of one gallon. When planted to serve as a hedge or screen, shrubs shall be planted with two to four feet of spacing, depending on the plant species. (c) Trees. Required trees must be planted in the ground. All parkway tree species shall be in accordance with the city's Street Tree Planting Plan. 1. Residential development. A minimum of one 24-inch box tree per 50 feet of street frontage shall be provided within the yard fronting the street. A minimum of at least one 24-inch box tree shall be required. 2. Mixed-use and non-residential development. a. A minimum of one 36-inch box tree per 50 feet of street frontage shall be provided within the yard fronting the street. b. A minimum of one tree of at least 15-gallon size shall be planted per 20 linear feet or as appropriate to create a tree canopy over the required setback along interior property lines abutting Residential Zones. (4) Artificial turf. (a) Material. Artificial turf must meet minimum material standards, including the following: 1. The turf shall have a minimum eight-year no-fade warranty as issued by the manufacturer. 2. The turf shall be cut-pile infill, minimum pile height one and two-thirds inches and a maximum of one and three-quarter inches, with parallel long slit blades. 3. The synthetic turf blades (not including the thatch layer) shall be required to contain at least two natural green colors. 4. The turf must contain a beige or tan thatch layer. 5. Be affixed to a permeable triple-layer backing and allow water to percolate through the synthetic grass at a drain rate of at least 30 inches per hour, to an adequate drainage system installed underneath the artificial turf to prevent run-off, pooling and flooding. 6. The synthetic turf shall comply with all federal and state standards related to lead and heavy metal content. 7. The fill material shall be of silica sand or zeolite material that is brushed in to keep the blades upright and achieve a natural grass look. Any replacement fill shall be the same. The use of rubber crumb infill is prohibited. 8. Must be constructed to maximize dimensional stability, resist damage during normal use and minimize UV degradation with a tear grab strength of at least 200 pounds. It must be resistant to staining, weather, insects, rot, mildew, and fungus and shall be non-allergenic and non-toxic and able to pass the pill burn test for flammability. 9. The use of infill or other compaction and artificial shade, flowers.</p>	
	<p>Duarte Station Specific Plan (Esperanza and Solana): All areas not covered by buildings, walkways, driveways, parking spaces, and service areas should be landscaped with climateappropriate plantings. Plant materials should favor native and native-compatible plants. Landscaping should enhance the quality of the project by defining edges, framing and softening the appearance of buildings, defining site functions, screening parking and storage areas, and buffering uses and neighboring properties. Landscaping at the base of buildings is encouraged to soften the transition between building and streets. Landscaped areas should generally incorporate plantings utilizing a three-tiered system: a) trees, b) shrubs or vines, c) groundcover. Landscaping should be in scale with the adjacent buildings and be of appropriate size at maturity. Placement of landscaping should not interfere with the lighting of the project area or restrict access to utilities. Planters and pots placed in building recesses, adjacent to walls, plazas, and courtyards are encouraged. Planters and pots should complement building architecture. Bio-retention areas can be used to detain run-off in planters. Street trees of a species identified by the City are required and should be spaced appropriately (in parkway strips or in tree-wells within wider sidewalks or plazas) to emphasize and reinforce the spatial definition between the building, pedestrian environment and the street. Design tree wells to be consistent the City's public realm tree well design, with tree wells occupying a minimum space of three feet by five feet to allow for healthy street trees.</p> <p>City of Duarte Residential architectural and design standards (applies to all residential zones): Multifamily Standards: Landscaping shall be provided consistent with the requirements of Chapter 19.40 (Landscaping). Parking shall be screened from streets through combined use of berming, walls, and landscaping (see Figure 3-21). Common open space areas shall be landscaped appropriate to their function. See common open space standards in Section 19.10.060 (R-3 and R-4 Zones: Additional Standards).</p> <p>City of Duarte Residential Landscaping Standards: The following standards shall apply to all parcels in all residential zones. A. A minimum of 20 percent of the entire parcel shall be fully landscaped with plant materials. B. At least 50 percent of the Front Yard Landscaped Area and 50 percent of the Visible Street Side Yard shall be landscaped with live vegetation, artificial turf, drought-tolerant landscaping or a combination of the three, as further described below. 1. Live vegetation may include turf, trees, shrubs, groundcover, flowers, or other similar vegetation. 2. Artificial turf is limited to no more than 40 percent coverage of the Front Yard Landscaped Area and shall include a minimum of 60 percent of live vegetation. Artificial turf is limited to no more than 40 percent coverage of the Visible Street Side Yard and shall include a minimum of 60 percent of live vegetation. (See Section 4.2 of the Guidelines) 3. Drought tolerant landscaping shall include native water conserving plants. (See Section 4.3 of the Guidelines) C. Artificial turf is not permitted within the parkway. D. Bare dirt is not permitted within the front yard, visible street side yard or within the parkway. All bare dirt areas shall be finished with a minimum three inch thick layer of mulch, organic bark or earth-toned colored rubber bark. E. Parking lots for multi-family developments providing 10 or more parking spaces shall be landscaped per the requirements of Section 19.38.200 (Parking Lot Landscaping).</p>		
			<p>R-3-13 Zone (Medium/High Density Residential Zone): Landscaping should be designed to minimize impact of development on surrounding properties. Tree preservation and landscaping with specimen trees are encouraged. All open areas with the exception of vehicular accessways and parking areas, pedestrian walkways and paved and/or covered recreational facilities shall be landscaped and permanently maintained in an attractive manner. For new construction, on-site trees equivalent to one, fifteen-gallon tree for each dwelling unit shall be provided. Additional trees and shrubs shall also be planted to provide a well-balanced landscape plan. For the purpose of this section other specimen material as approved by the planning department may be considered as equivalent to a fifteen-gallon tree. Commercial Zone: All site landscaping shall be so designed with both form and function in mind and not just as a decorative element. Desirable aspects of landscape design that are: 1. Plant material selection for seasonal color; 2. Low maintenance plant materials; 3. Use of ground cover plant materials rather than nonplant substitutes; 4. Use of native trees when appropriate. Review of a proposed design shall be related to the surrounding existing development with greater emphasis placed upon compatibility with adjacent development related to: g. Landscaping The provisions of Chapter 17.68 shall apply in addition to the following: A. All open areas with the exception of vehicular accessways and parking areas, pedestrian walkways, approved outdoor seating and sales areas, and paved or covered recreational facilities shall be landscaped and irrigated. Such landscaping and irrigation system shall be permanently maintained. Existing trees to be removed shall be replaced with a substitute specimen trees (minimum thirty-inch box container size) elsewhere on the site. B. All planted areas shall be surrounded by a curb of concrete or comparable material at least six inches above the higher of the final grade or the pavement of the parking lot, except when such planted areas lie adjacent to a paved sidewalk, masonry wall or a building. C. Landscaping shall consist of trees, shrubs and ground covers with careful consideration given to eventual size, form, susceptibility to disease and pests, durability, water consumption and adaptability to soil and climate conditions. D. A landscape plan drawn at a scale of not less than one inch to thirty feet shall be submitted and shall include: 1. Square footage of each landscaped area; 2. Total square footage of all landscaped areas; 3. Percentage of the site devoted to landscaping; 4. Type of plant materials, i.e., the botanical and common names; 5. Location of all plant materials; 6. Container size and number of all plant materials; 7. Type, size and location of a permanent irrigation system.</p> <p>RHO (Religious Housing Overlay) Zone: Landscaping should be designed to minimize impact of development on surrounding properties. Tree preservation and landscaping with specimen trees are encouraged.</p>
Parking Requirements		<p>Duarte Station Specific Plan (Esperanza and Solana): Studio/1-Bedroom: 1 per unit 2-Bedroom: 1.8 per unit 3-Bedroom: 2 per unit Guest spaces: Projects over 150 units: 0.15 per unit; projects 149 units or less: 0.2 per unit Tandem Parking: Residential - Allowed if both spaces are shared by the same unit Affordable Housing Parking Requirements - the number of required parking spaces for affordable housing developments shall be determined on a case-by-case basis to ensure the economic feasibility of affordable housing projects. The parking requirement shall be determined by the Community Development Director or designee or the final decisionmaking body if associated with an entitlement package subject to Planning Commission or City Council review. Duarte Town Center Specific Plan: Mixed-Use Parking Allowances • The first 1,000 square feet of gross commercial floor area in a mixed-use development is exempt from providing off-street parking. • Guest spaces for residential uses may be fulfilled through required commercial parking (shared). • Parking requirements may be reduced up to 50 percent, subject to a conditional use permit and required parking study completed by the City and paid for by the applicant/developer. Residential Parking Requirements: Live-Work Unit: 2 spaces per unit and 1 guest parking space per each 2 units Studio and 1-bedroom units: 1 space per dwelling unit, plus 1 guest parking space per each 4 units 2-bedroom units: 2 spaces per dwelling unit with 2 bedrooms, plus 1 guest parking space per each 4 units 3-bedroom+ (includes 2-bedroom with den): Parking requirements are to be determined through required parking analysis. For multi-family development projects, tandem spaces shall not constitute more than 50 percent of all required spaces within a development. Tandem spaces shall not be permitted for guest spaces.</p>	
Sloping			<p>R-3-13 Zone (Medium/High Density Residential Zone): Landscaping should be designed to minimize impact of development on surrounding properties. Tree preservation and landscaping with specimen trees are encouraged. All open areas with the exception of vehicular accessways and parking areas, pedestrian walkways and paved and/or covered recreational facilities shall be landscaped and permanently maintained in an attractive manner. For new construction, on-site trees equivalent to one, fifteen-gallon tree for each dwelling unit shall be provided. Additional trees and shrubs shall also be planted to provide a well-balanced landscape plan. For the purpose of this section other specimen material as approved by the planning department may be considered as equivalent to a fifteen-gallon tree. Commercial Zone: All site landscaping shall be so designed with both form and function in mind and not just as a decorative element. Desirable aspects of landscape design that are: 1. Plant material selection for seasonal color; 2. Low maintenance plant materials; 3. Use of ground cover plant materials rather than nonplant substitutes; 4. Use of native trees when appropriate. Review of a proposed design shall be related to the surrounding existing development with greater emphasis placed upon compatibility with adjacent development related to: g. Landscaping The provisions of Chapter 17.68 shall apply in addition to the following: A. All open areas with the exception of vehicular accessways and parking areas, pedestrian walkways, approved outdoor seating and sales areas, and paved or covered recreational facilities shall be landscaped and irrigated. Such landscaping and irrigation system shall be permanently maintained. Existing trees to be removed shall be replaced with a substitute specimen trees (minimum thirty-inch box container size) elsewhere on the site. B. All planted areas shall be surrounded by a curb of concrete or comparable material at least six inches above the higher of the final grade or the pavement of the parking lot, except when such planted areas lie adjacent to a paved sidewalk, masonry wall or a building. C. Landscaping shall consist of trees, shrubs and ground covers with careful consideration given to eventual size, form, susceptibility to disease and pests, durability, water consumption and adaptability to soil and climate conditions. D. A landscape plan drawn at a scale of not less than one inch to thirty feet shall be submitted and shall include: 1. Square footage of each landscaped area; 2. Total square footage of all landscaped areas; 3. Percentage of the site devoted to landscaping; 4. Type of plant materials, i.e., the botanical and common names; 5. Location of all plant materials; 6. Container size and number of all plant materials; 7. Type, size and location of a permanent irrigation system.</p> <p>RHO (Religious Housing Overlay) Zone: Landscaping should be designed to minimize impact of development on surrounding properties. Tree preservation and landscaping with specimen trees are encouraged.</p>

Exhibit A	Duarte	Alhambra	Sierra Madre
			<p>R-3-13 Zone (Medium/High Density Residential Zone): 1 space for studio or 1 bedroom unit 2 spaces for 2 bedroom unit or more Commercial Zone: A. The number of off-street parking spaces required for residential uses shall be as follows: 1. For each dwelling unit with a floor area (not counting parking area) up to one thousand square feet: one parking space. 2. For each dwelling unit with a floor area (not counting parking area) greater than one thousand and up to three thousand five hundred square feet: two parking spaces. 3. For each dwelling unit with a floor area (not counting parking area) greater than three thousand five hundred square feet: three parking spaces. 4. For multi-family projects, guest parking shall be required at a ratio of one parking space per five dwelling units, rounded to the nearest whole number; provided however, that no guest parking shall be required for the first four dwelling units in each multi-family project. For example, a multi-family project with fifteen dwelling units would require two guest parking spaces (as the project would have eleven dwelling units subject to the guest parking requirement, multiplied by 0.2 equals 2.2, which would be rounded down to two). 5. For each affordable unit, the number of required parking spaces shall be one fewer per dwelling unit than required by subsections 1 through 3 above, and no guest parking shall be required for a multi-family project that includes one or more affordable units. 6. Parking for second units shall be provided in accordance with Chapter 17.22. 7. Required parking for group living facilities subject to a conditional use permit shall be determined by the planning commission. In addition to other findings required in order to approve any such application, the planning commission shall also find the proposed group living facility will not unreasonably overload street parking or public parking facilities nor create a nuisance. 8. Emergency shelters shall accommodate all staff working in the emergency shelter. One parking space for each employee or volunteer on duty, plus one space for every vehicle operated by the facility, provided that the standards do not require more parking for emergency shelters than other residential or commercial uses within the same zone.</p> <p>RHO (Religious Housing Overlay) Zone: Development under the RHO zone is eligible for the alternative or special parking standards described in Section 17.34.070. Alternative Parking Standards: 0-1 bedrooms, 0.5 spaces 2-3 bedrooms, 1 space 4+ bedrooms, 2 spaces Special Parking Standards: 0.5 spaces for Housing development with at least 11% very low income, 20% lower income, or 40% moderate income units and located within one-half mile of a major transit stop 0 spaces for: -Development 100% affordable to lower income households and located within one-half mile of major transit stop -Senior housing development 100% affordable to lower income households, with paratransit service or located within one-half mile of a bus route operating at least 8 times per day -Special needs housing development 100% affordable to lower income households, with paratransit service or located within one-half mile of a bus route operating at least 8 times per day -A supportive housing development 100% affordable to lower income households</p>
			<p>Chapter 23.20 Parking and Loading: Multi-unit parking requirement - 2 spaces within an enclosed garage per unit, 0.5 guest parking space per unit. Guest parking may be uncovered CBD Zoning District multi-unit parking requirement: 1.5 spaces per unit plus 0.3 guest parking spaces per unit RM (Residential Medium) Zone and RM (Residential Medium) Zone: Sloping lot adjustment. Where a lot has a slope greater than 25 percent, measured from the curb line to a point midway between the side lot lines at a distance of 50 feet from the front lot line, the minimum required front setback is that of the zone. An attached or detached garage with a maximum capacity of two cars and no more than 10 feet in height measured from the front property line, may be set back a minimum of five feet from the front and side property lines.</p>

Appendix E: SGVCOG Regional Objective Design Standards Research Memorandum

Memo of ODS | The Arroyo Group
SGV COG Objective Design Standards
25 September 2025



EXHIBIT B

MEMORANDUM OF OBJECTIVE DESIGN STANDARDS RESEARCH

P25056 | SGV COG Objective Design Standards | San Gabriel Valley

ONYX Architects was contracted as a consultant to The Arroyo Group to assist with the development of a Regional Objective Design Standard (ODS) applicable to the San Gabriel Valley. In an effort to complete Task 2 – Research and Outlines, under the list of SGVCOG & The Arroyo Group approved deliverables and outlined tasks, ONYX has prepared this memorandum that list specific observations of successful and unsuccessful ODS documents based on its effectiveness in implementation to a city or community.

Following is a summary and/or list of findings from ONYX's experience and research of successful or unsuccessful regional zoning approaches and effective ODS implementation in other cities.

COUNTY OF SAN FRANCISCO - ODS

Latest draft completed on May 30, 2024, this document starts with the California State law that requires housing projects subject to the Housing Accountability Act (HAA) to be reviewed with design criteria under the definition of Objective Standards. This ODS considers immediate context in reviewing the appropriateness of a proposed development's siting, size, programing and design.

Successful aspects:

- Covers a range of scales – site design, building massing, and architecture.
- Ensures development reflects key features of a walkable urban environment
- Provides standards that address issues related to a new building's relationship to its existing context
- Provides architectural standards that are focused on creating dimension, texture, and character critical for creating an engaging pedestrian friendly environment
- Establishes a clear structure for each "standard", which each standards is listed & described, gives all-encompassing rationale, and illustrations that further describe its application.
- Provides options for different block confirmations / sizes, which is clearly distinguished by measurable sizes.
- Identifies certain districts / communities where standards are applicable.
- References code compliance as needed.
- Provides a mix of graphics, diagrams, and photograph illustrations

Unsuccessful aspects:

- Does not capture unique site conditions, such as terrain or easements, or odd shaped lots
- Not enough graphics to capture each 'standard'.
- Graphics are too detailed and do not highlight the key aspects of the standard / design intent
- Does not provide enough alternatives, for example building mass, standard states 'when building abuts the side property line of a residential property, the first 10 lateral feet of the new building shall be no taller than the height of the adjacent structure.' This standard is ambiguous, particularly regarding how height is measured and whether features such as penthouses, parapets, or railing are included. Additionally, the graphics provided only depict flat roofs, offering limited applicability to different building types.
- Does not guide standards to be located or emphasized in certain locations. For instance, where modulation is required, focus modulation at primary entries or openings, if in series distribute evenly throughout the building façade, etc.
- Missing a definitions page for architectural elements / features. Graphics are not enough.

Screenshot of County of San Francisco ODS document

04. STEPBACKS

In some circumstances, particularly where taller buildings are introduced immediately abutting buildings or lots anticipated to stay at lower scale, upper story stepbacks of the new larger building helps create a more sensitive and less abrupt transition. These ODS provide quantitative requirements with the emphasis of modest stepping back at the side and rear when abutting residentially zoned properties (properties zoned RH, RM, or RTO) that have height limits of 45 feet or below, while maximizing new housing development toward the front of the property.

- S.4.1 When a new building abuts the rear property line of residential property (or properties), the first ten lateral feet of the building measured from the shared property line shall be no taller than 55 feet.
- S.4.2 When a building abuts the side property line of a residential property, the first ten lateral feet of the new building measured from the shared property line shall be no taller than the height of the adjacent structure. If the adjacent property is vacant, the height shall be no taller than 45 feet.
- S.4.3 Where a property's rear yard abuts the rear yard(s) of residentially-zoned property(s), and has a lot depth of 100 feet or greater, the portion of the building that is within the last 25 feet of the lot depth shall have a maximum height of 55-feet.



Appendix E: SGVCOG Regional Objective Design Standards Research Memorandum

Call-outs for County of San Francisco ODS document

04. STEPBACKS

In some circumstances, particularly where taller buildings are introduced immediately abutting buildings or lots anticipated to stay at lower scale, upper story stepbacks of the new larger building helps create a more sensitive and less abrupt transition. These ODS provide quantitative requirements with the emphasis of modest stepping back at the side and rear when abutting residentially zoned properties (properties zoned RH, RM, or RTO) that have height limits of 45 feet or below, while maximizing new housing development toward the front of the property.

- S.4.1 When a new building abuts the rear property line of residential property (or properties), the first ten lateral feet of the building measured from the shared property line shall be no taller than 55 feet.
- S.4.2 When a building abuts the side property line of a residential property, the first ten lateral feet of the new building measured from the shared property line shall be no taller than the height of the adjacent structure. If the adjacent property is vacant, the height shall be no taller than 45 feet.
- S.4.3 Where a property's rear yard abuts the rear yard(s) of residentially-zoned property(s), and has a lot depth of 100 feet or greater, the portion of the building that is within the last 25-feet of the lot depth shall have a maximum height of 55-feet.

Provides clear rationale that ties back to the County's values of well design and contributes to vibrant urban places.

Provides different options for standards that addresses the same issue but dependent on the site context or circumstance.

Provides standards that address issues related to a new building's relationship to its existing context

Identifies certain districts or communities where standards are most applicable.

Provides a specific and measurable requirement for each standard

Presents graphics that emphasize dimension, texture, and site context

CITY OF DEL MAR - ODS

The latest draft completed on September 2024, this document starts with the California State law that requires housing project subject to the Housing Accountability Act (HAA) to be reviewed with design criteria under the definition of Objective Standards. It also discusses its intent of protecting the City's unique residential seaside community.

Successful aspects:

- Covers a range of scales – site planning and design, building design, and ground-floor design.
- Provides a definitions section.
- Provides administrative exceptions with detailed explanation
- Establishes a clear structure for each “standard”, which each standard is listed & described, gives all-encompassing rationale, and illustrations that further describe its application.
- Provides options of site and building features to choose from as it relates to a standard
- Clearly labels each illustration as it relates to each standard
- Illustrations are clear and highlight each standard with consistent graphics. This helps both applicant's and city staff understand each design standard
- Includes photos of successful project in the city which is in compliance to one or multiple standards.
- Provide an asterisk to each standard, when non-applicable to a certain district or neighborhood.
- Overall, format, font, layout, and graphics are consistent, not-overpowering, and legible.

Unsuccessful aspects:

- Rational is over simplified and not connected to all sub-categories / standards.
- Does not provide enough information on building finishes, materials, or color as it relates to building type or architectural style.
- Overall, the ODS could use a section that describes districts or neighborhoods in question. This will need to be cross-referenced with current city maps.
- Definitions could use graphics to help understand.

Appendix E: SGVCOG Regional Objective Design Standards Research Memorandum

Screenshot of City of Del Mar ODS document

B. Site Planning and Design

The building placement, arrangement of activities and design of the site are significant factors in maintaining the unique character and scale of Del Mar's existing neighborhoods. The Site Planning and Design section addresses the standards for the following topics:

- B.1 Neighborhood Compatibility
- B.2 Floodplain Overlay Zone
- B.3 Natural Topography and Grading
- B.4 Retaining Walls and Fencing
- B.5 Circulation and Parking
- B.6 Hardscape
- B.7 Landscape and Vegetation
- B.8 Open Space

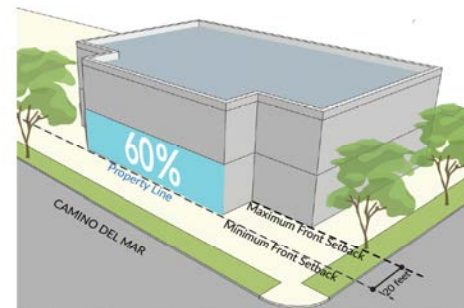

B.1. Neighborhood Compatibility

Ensure that new multi-unit residential and mixed-use development reflects the scale and character of Del Mar's existing neighborhoods.

SETBACKS

1. Front, side, and rear yard setbacks shall meet the minimum standards set in the DMMC Title 30 - Zoning.
2. For parcels that face Camino Del Mar, the following standards shall apply:
 - a. Along Camino Del Mar between Del Mar Heights Road/4th Street and 15th Street, the following shall be included:
 - A 10-foot minimum public sidewalk, measured perpendicularly from the existing curb line.
 - The 10-foot sidewalk shall include a 5-foot landscaping and furniture zone and a 5-foot continuous walkway.
 - b. Where there is no minimum front yard setback required, buildings may be built up to the property line.
 - c. Along Camino Del Mar, between 10th and 13th streets where "Town and Country" parking has been provided in the front yard setback, the existing setback shall be considered the minimum front yard setback.
3. A minimum of 60% of the building facing Camino Del Mar and any intersecting street (where the parcel faces two streets) shall meet the minimum front yard setback as shown in Figure B-1.
 - a. The remaining building frontage may be set back up to 20 feet to allow for one or more site features including:
 - Plazas
 - Landscaping
 - Open space
 - Outdoor dining
 - Building entries
 - Building articulation

Call-outs for City of Del Mar ODS document

Provides clear rationale that ties back to the City's aesthetic context and unique natural asset / qualities.

Identifies certain districts or communities where standards are most applicable.

B. Site Planning and Design

The building placement, arrangement of activities and design of the site are significant factors in maintaining the unique character and scale of Del Mar's existing neighborhoods. The Site Planning and Design section addresses the standards for the following topics:

- B.1 Neighborhood Compatibility
- B.2 Floodplain Overlay Zone
- B.3 Natural Topography and Grading
- B.4 Retaining Walls and Fencing
- B.5 Circulation and Parking
- B.6 Hardscape
- B.7 Landscape and Vegetation
- B.8 Open Space

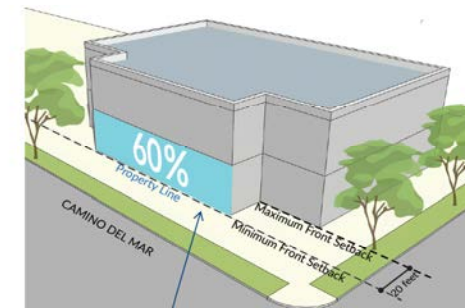

B.1. Neighborhood Compatibility

Ensure that new multi-unit residential and mixed-use development reflects the scale and character of Del Mar's existing neighborhoods.

SETBACKS

1. Front, side, and rear yard setbacks shall meet the minimum standards set in the DMMC Title 30 - Zoning.
2. For parcels that face Camino Del Mar, the following standards shall apply:
 - a. Along Camino Del Mar between Del Mar Heights Road/4th Street and 15th Street, the following shall be included:
 - A 10-foot minimum public sidewalk, measured perpendicularly from the existing curb line.
 - The 10-foot sidewalk shall include a 5-foot landscaping and furniture zone and a 5-foot continuous walkway.
 - b. Where there is no minimum front yard setback required, buildings may be built up to the property line.
 - c. Along Camino Del Mar, between 10th and 13th streets where "Town and Country" parking has been provided in the front yard setback, the existing setback shall be considered the minimum front yard setback.
3. A minimum of 60% of the building facing Camino Del Mar and any intersecting street (where the parcel faces two streets) shall meet the minimum front yard setback as shown in Figure B-1.
 - a. The remaining building frontage may be set back up to 20 feet to allow for one or more site features including:
 - Plazas
 - Landscaping
 - Open space
 - Outdoor dining
 - Building entries
 - Building articulation

Illustrations are clear and highlights each standard with consistent graphics

Provides a list of site or building feature options that aligns with standard while providing some flexibility

Provides a reference to illustration(s) as it relates to the specific standard

Appendix E: SGVCOG Regional Objective Design Standards Research Memorandum

Memo of ODS | The Arroyo Group
SGV COG Objective Design Standards
9 September 2025

CITY OF ORANGE - ODS

The latest draft completed on September 2024, this document starts with the California State law that requires housing project subject to the Housing Accountability Act (HAA) to be reviewed with design criteria under the definition of Objective Standards. It also clarifies that the standards may also be implemented as a replacement or to add supplemental detail specific existing standards, which is what the SGVCOG is expecting.

Successful aspects:

- Covers a range of scales – site planning and operations, form & scale, frontage, and open space.
- Provides information about instance of conflict between standards and the City's Municipal Code.
- Clarifies when the document provides options for the City as opposed to implementing multiple together.
- Each standard has a reference number / label to the city's municipal code.
- Standards includes a list of options to pick from, such as "at least three"
- Address Easements, Emergency Vehicle Circulation, and other special case situations
- Provides a detailed glossary / definitions
- Illustration are clear and highlight each standard. This helps both applicant's and city staff understand each design standard.
- Overall, format, font, layout, and graphics are consistent, not-overpowering, and legable.

Unsuccessful aspects:

- Does not provide enough graphics for many standards
- Rational could be focused on a singular design aspect. Too over-arching
- Overall, the ODS could use a section that describes districts or neighborhoods in question. This will need to be cross-referenced with current city maps.
- Definitions could use graphics to help understand.

Screenshot of City of Orange ODS document

Building Length / Façade Break

Street-facing elevations shall be no longer than 100 feet in length, without providing either a Façade Break or a Building Break:

- A Façade Break shall have a depth of no less than 10 feet. Additionally, a Façade Break shall have a width of no less than 10% of the building length or 20 feet, whichever is the greater.
- A Building Break shall provide no less than 15 feet of building separation. Buildings of 5 stories or higher shall provide a Building Break of not less than 20 feet of building separation.¹
- These areas shall be activated with planted landscape material, and a maximum of 25 percent of the area may be paved.

Façade planes adjacent to R1 and MH zoning districts shall not exceed 50 feet in length without a Façade Break of at least 5 feet deep and 10 feet wide.

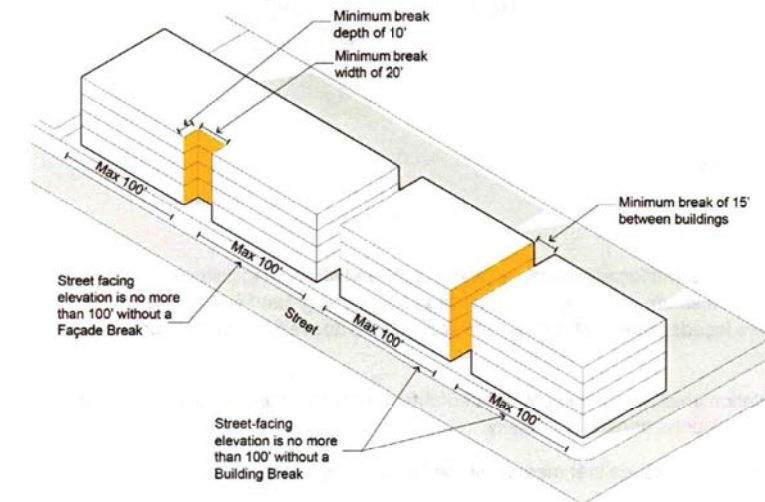

Corner Treatments

Corner-facing facades of 75 feet or longer shall incorporate at least two of the following elements within 50 feet of the building corner along the street facing Building Frontage/s:

- A building entrance;
- A change in height of at least 4 feet for an area 10 feet by 10 feet minimum;
- A change in façade plane on upper stories of at least 5 feet in depth;
- A change of façade material or texture (excluding windows, doors and railings);
- A public open space or outdoor dining.

¹ Orange Municipal Code Section 17.19.090.B should be referenced for separation requirements where internal facing windows between buildings are involved.

Appendix E: SGVCOG Regional Objective Design Standards Research Memorandum

Call-outs for City of Orange ODS document

Standards are clear and measurable both in text and graphically represented

Provides different options to address the standard which providing some flexibility

Building Length / Façade Break

Street-facing elevations shall be no longer than 100 feet in length, without providing either a Façade Break or a Building Break:

- i) A Façade Break shall have a depth of no less than 10 feet. Additionally, a Façade Break shall have a width of no less than 10% of the building length or 20 feet, whichever is the greater.
- ii) A Building Break shall provide no less than 15 feet of building separation. Buildings of 5 stories or higher shall provide a Building Break of not less than 20 feet of building separation.¹
- iii) These areas shall be activated with planted landscape material, and a maximum of 25 percent of the area may be paved.

Façade planes adjacent to R1 and MH zoning districts shall not exceed 50 feet in length without a Façade Break of at least 5 feet deep and 10 feet wide.

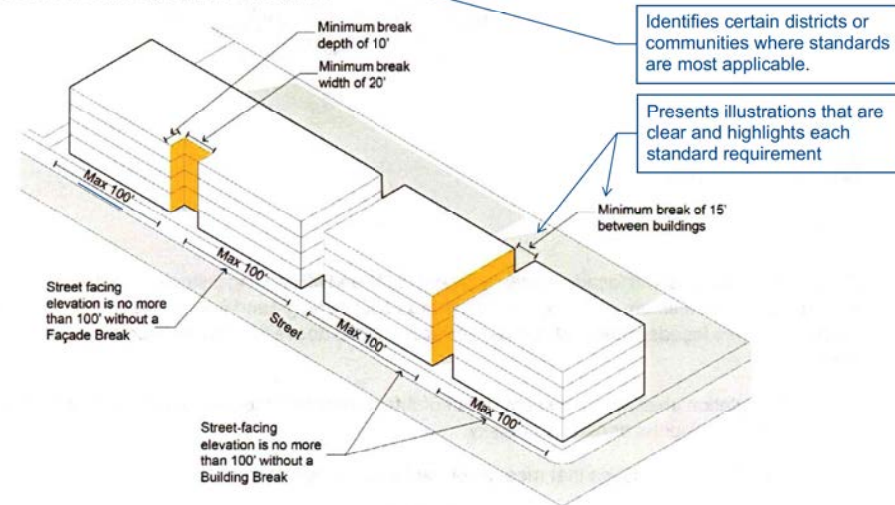

Identifies certain districts or communities where standards are most applicable.

Presents illustrations that are clear and highlights each standard requirement

Corner Treatments

Corner-facing facades of 75 feet or longer shall incorporate at least two of the following elements within 50 feet of the building corner along the street facing Building Frontage/s:

- a) A building entrance;
- b) A change in height of at least 4 feet for an area 10 feet by 10 feet minimum;
- c) A change in façade plane on upper stories of at least 5 feet in depth;
- d) A change of façade material or texture (excluding windows, doors and railings);
- e) A public open space or outdoor dining.

Provide additional municipal code sections as other related issues may apply

Establishes a clear list of design elements or features to implement as it relates to the standard

¹ Orange Municipal Code Section 17.19.090.B should be referenced for separation requirements where internal facing windows between buildings are involved.

CITY OF SANTA BARBARA - ODS

The latest effective as of March 27, 2025, this document starts with the California State law that requires housing project subject to the Housing Accountability Act (HAA) to be reviewed with design criteria under the definition of Objective Standards. It provides clear goals and relationship to General Plan.

Successful aspects:

- It identifies zones/districts/neighborhood by table and key map
- Covers a range of scales – site design, building types, frontages, and architectural design
- Provides an exceptions section
- Provides a definitions section
- Provides architectural style section that relates to the City's Municipal Code.
- The overall document is formatted in a table list format with keynotes that refer to graphics
- Very detailed description of standards and definitions
- Provides photo examples based on building typology and multiple photos
- Provides elements of different architectural styles and character defining features.

Unsuccessful aspects:

- Keynotes are too similar and hard to follow
- Text is very code format and can be overwhelming

Appendix E: SGVCOG Regional Objective Design Standards Research Memorandum

Screenshot of City of Santa Barbara ODS document

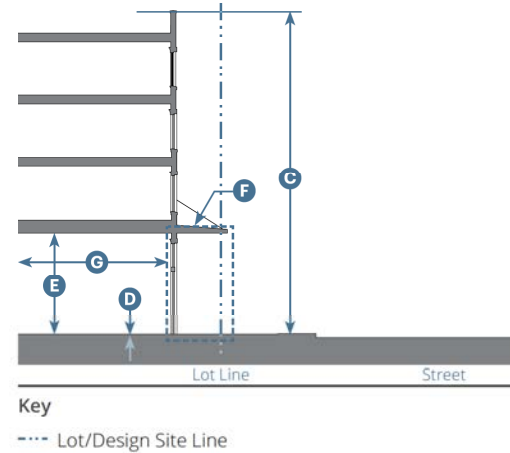
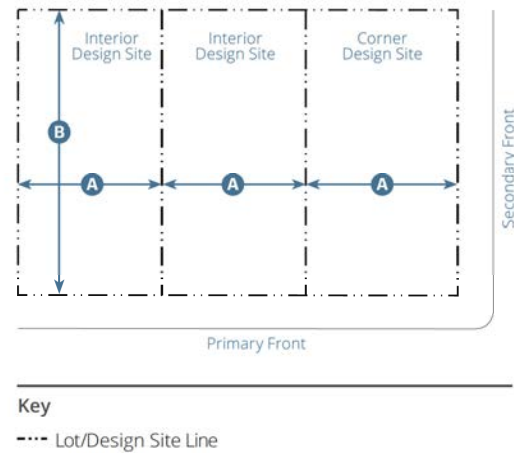

B. Building Types and Design Site Size			
Allowed Building Types	Design Site		Standards
	Width A	Depth B	
Duplex Side-by-Side	50' min.	100' min.	25.04.050
Duplex Stacked	50' min.	100' min.	25.04.060
Cottage Court	90' min.	120' min.	25.04.070
Medium Multiplex	50' min.	110' min.	25.04.080
Duplex Court	50' min.	110' min.	25.04.090
Side Court	50' min.	100' min.	25.04.100
Medium Courtyard	70' min.	150' min.	25.04.110
Block-Scale			
Large Multiplex	75' min.	110' min.	25.04.120
Large Courtyard	75' min.	120' min.	25.04.130
Downtown Building	25' min.	100' min.	25.04.140

Each design site shall have only one main building type.

C. Building Form			
Height			
Main Building			
Max. Stories	See standards in Chapter 25.04 (Building Types)		
Overall	48' max.		C
Ground Floor Finish Level			D
Residential	6" min. ¹		
Nonresidential	6" max.		
Ground Floor Ceiling			E
Residential	9' min.		
Nonresidential	14' min.		
Frontage	See Subsection F (Frontages)		F

Design Site Coverage			
Max. Building Footprint	See standards in Chapter 25.04 (Building Types)		
Depth, Ground-Floor Space			G
Cottage Court	12' min. ²		
All Building Types	25' min. ²		

¹ Common entries may be set at grade in compliance with local and federal accessibility standards.
² For occupiable space only. Projects on lots fronting State Street between Montecito Street and Sola Street are required to provide ground floor nonresidential uses.

Call-outs for City of Santa Barbara ODS document

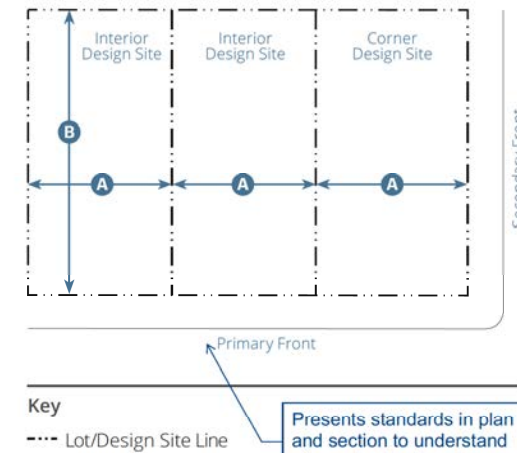

Provides architectural section that relates to both standards and municipal code sections.

Graphics provide keynotes that tie back to a list of standards to keep graphics free from clutter

B. Building Types and Design Site Size			
Allowed Building Types	Design Site		Standards
	Width A	Depth B	
Duplex Side-by-Side	50' min.	100' min.	25.04.050
Duplex Stacked	50' min.	100' min.	25.04.060
Cottage Court	90' min.	120' min.	25.04.070
Medium Multiplex	50' min.	110' min.	25.04.080
Duplex Court	50' min.	110' min.	25.04.090
Side Court	50' min.	100' min.	25.04.100
Medium Courtyard	70' min.	150' min.	25.04.110
Block-Scale			
Large Multiplex	75' min.	110' min.	25.04.120
Large Courtyard	75' min.	120' min.	25.04.130
Downtown Building	25' min.	100' min.	25.04.140

Each design site shall have only one main building type.

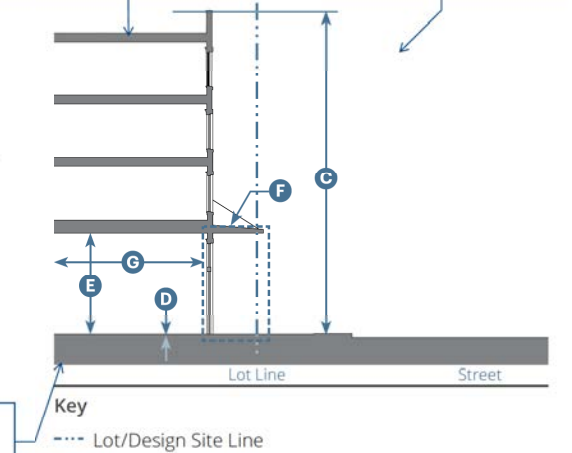

C. Building Form			
Height			
Main Building			
Max. Stories	See standards in Chapter 25.04 (Building Types)		
Overall	48' max.		C
Ground Floor Finish Level			D
Residential	6" min. ¹		
Nonresidential	6" max.		
Ground Floor Ceiling			E
Residential	9' min.		
Nonresidential	14' min.		
Frontage	See Subsection F (Frontages)		F

Design Site Coverage			
Max. Building Footprint	See standards in Chapter 25.04 (Building Types)		
Depth, Ground-Floor Space			G
Cottage Court	12' min. ²		
All Building Types	25' min. ²		

¹ Common entries may be set at grade in compliance with local and federal accessibility standards.
² For occupiable space only. Projects on lots fronting State Street between Montecito Street and Sola Street are required to provide ground floor nonresidential uses.

Takes into consideration different site conditions and building types per standard

Standards have an Astrix or footnote that relates to additional information, definitions, or local or federal code section

Appendix E: SGVCOG Regional Objective Design Standards Research Memorandum

COUNTY OF SAN LUIS OBISPO – DESIGN GUIDELINES

The City of San Luis Obispo provides design guidelines that consist of design objectives, guidelines, and examples that retain and enhance the unique character of the County. This document is old, but upholds the diverse and unique qualities of village and urban areas.

Successful aspects:

- Focuses on specific centers, districts, downtowns, and development by use
- Detailed guidelines with measurable goals and clear examples
- Relates to other city documents for each guideline
- Very detailed definitions / glossary

Unsuccessful aspects:

- Outdated, so does not account for or promote certain uses or typologies
- Graphics may be misleading due to over generalizing the design intent / goal

CITY OF TORRANCE – DESIGN GUIDELINES

The City of Torrance provides a quick-guide or reference to common Architectural styles, Architectural terms, and rehabilitation of historic buildings in the city: Architectural Design Guidelines | City of Torrance. This can be an example of a simple layout for descriptive architectural styles.

Successful aspects:

- Covers the main character defining features of each architectural style in 2 pages or less.
- Graphics are consistent with each other

Unsuccessful aspects:

- Photo illustrations are very traditional and doesn't account for new construction, where certain elements or features can be difficult to build but possible. Just needs more modern examples.

SCAG Objective Design Standards

In 2022-2023, the Southern California Association of Governments (SCAG) initiated a project to develop a common set of objective design standards that could then be tailored to the communities of Santa Monica, South Pasadena, Montebello and Santa Fe Springs. The standards were simple in nature and able to be inserted into the zoning code. However, ultimately, the needs of each community were very different, leading to limited utilization. Santa Fe Springs, which was seeking to create a new downtown, adopted the objective standards into its zoning code. However, in South Pasadena, the Planning Commission and community members felt that the standards did not adequately take into account that city's unique needs. In Santa Monica, the draft was reduced to a limited set of standards and ultimately not adopted. Montebello has not adopted its standards either. The project exposes the conundrum of regional design standard efforts; community character and regulatory structure can be very different in different jurisdictions, leading to very different design standard needs. Projects either respond by becoming more focused on the particular jurisdictions involved and crafting standards for their unique needs, or abstracting the process into mere recommendations rather than implementable standards.

Strengths:

- Simple, clear diagrams
- Contains standards about unique topics, such as horizontal elements, enhancement of blank walls, security bars
- Simplified frontage regulations
- Menu of choices for modulation and façade composition

Weaknesses:

- Difficult to formulate a correct approach to some topics (for example, streetwall and massing) given the great diversity in built environment among the four cities
- No photographic examples
- No rationale provided for standards

San Joaquin Valley Objective Design Standards Guidebook

The Fresno Council of Governments led an effort to create a guidebook that could serve the entire San Joaquin, or Central, Valley. The background information is a good resource to help guide the structuring and utilization of Objective Design Standards.

Strengths:

- Includes a summary of legal considerations, including the difference between HAA (streamlined approval process) and SB35 (ministerial approval process).
- Gives good guidance as a regional document to local jurisdictions about the various methods of constructing objective design standards, and the considerations between these methods.
- Describes best practices which include the use of guidelines or intent statements to clarify the purpose and goal of statements, and allow flexibility
- Describes different approval processes for projects which meet standards, which meet the intent but not letter of the standards, or which do not meet the standards

Weaknesses:

- Community character is less relevant to San Gabriel Valley
- Does not present actual recommended objective design standards

Appendix E: SGVCOG Regional Objective Design Standards Research Memorandum

Western Riverside Council of Governments Objective Design Standards Toolkit

This toolkit was prepared in 2022; some cities later adapted and adopted it (e.g. Temecula). A chapter on landscape standards is particularly noteworthy.

Strengths:

- Includes landscape standards
- Graphics show multiple standards at once
- Provides thorough common open space standards

Weaknesses:

- Some standards are more appropriate to large, master-planned type projects more common in Riverside County

Memo of ODS | The Arroyo Group SGV
COG Objective Design Standards
25 September 2025

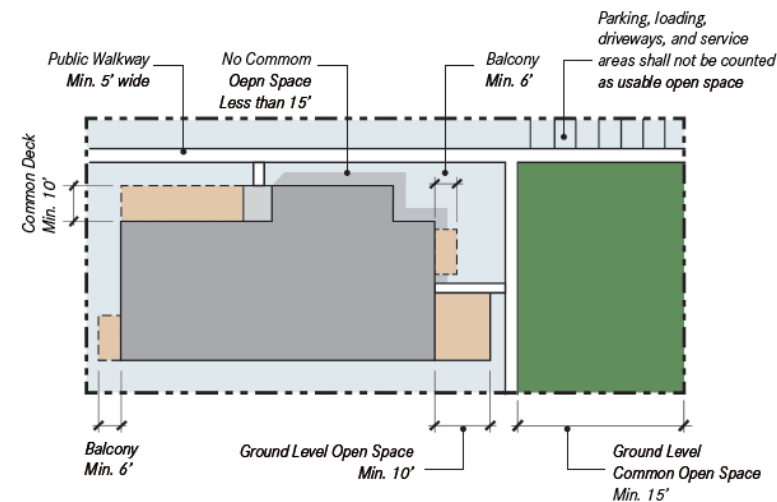

ABAG Objective Design Standards Handbook

This is a well-written, beautifully prepared guidebook for residential and mixed-use projects in the San Francisco Bay Area. The guidebook approaches the biggest issues in objective design standards holistically, with perspectives discussing the economic, design and community planning considerations of using such tools as building types, frontage types, and building modulation standards. It will be a useful resource when evaluating different design standards for the San Gabriel Valley.

Strengths:

- Provides a lot of explanation around the recommended standards, and complements regulatory diagrams with recommended and not recommended photographic examples
- Conducted interviews with developers to determine the impact of different types of objective design standards on economic feasibility
- Standards of particular interest include a more comprehensive list of frontage types, roof standards, and block and open space standards for large sites
- Attempts to classify the Bay Area into PlaceTypes where different standards will apply

Weaknesses:

- Standards and graphics are adapted from form-based codes, which may be more difficult to map on to cities' existing standards
- Mostly focused on high-density development
- Place Type application may be difficult in different jurisdictions

EXHIBIT C

Appendix E: SGVCOG Regional Objective Design Standards Research Memorandum

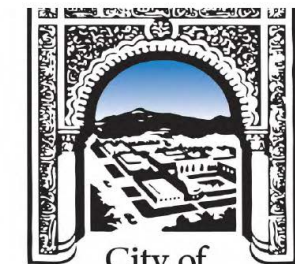
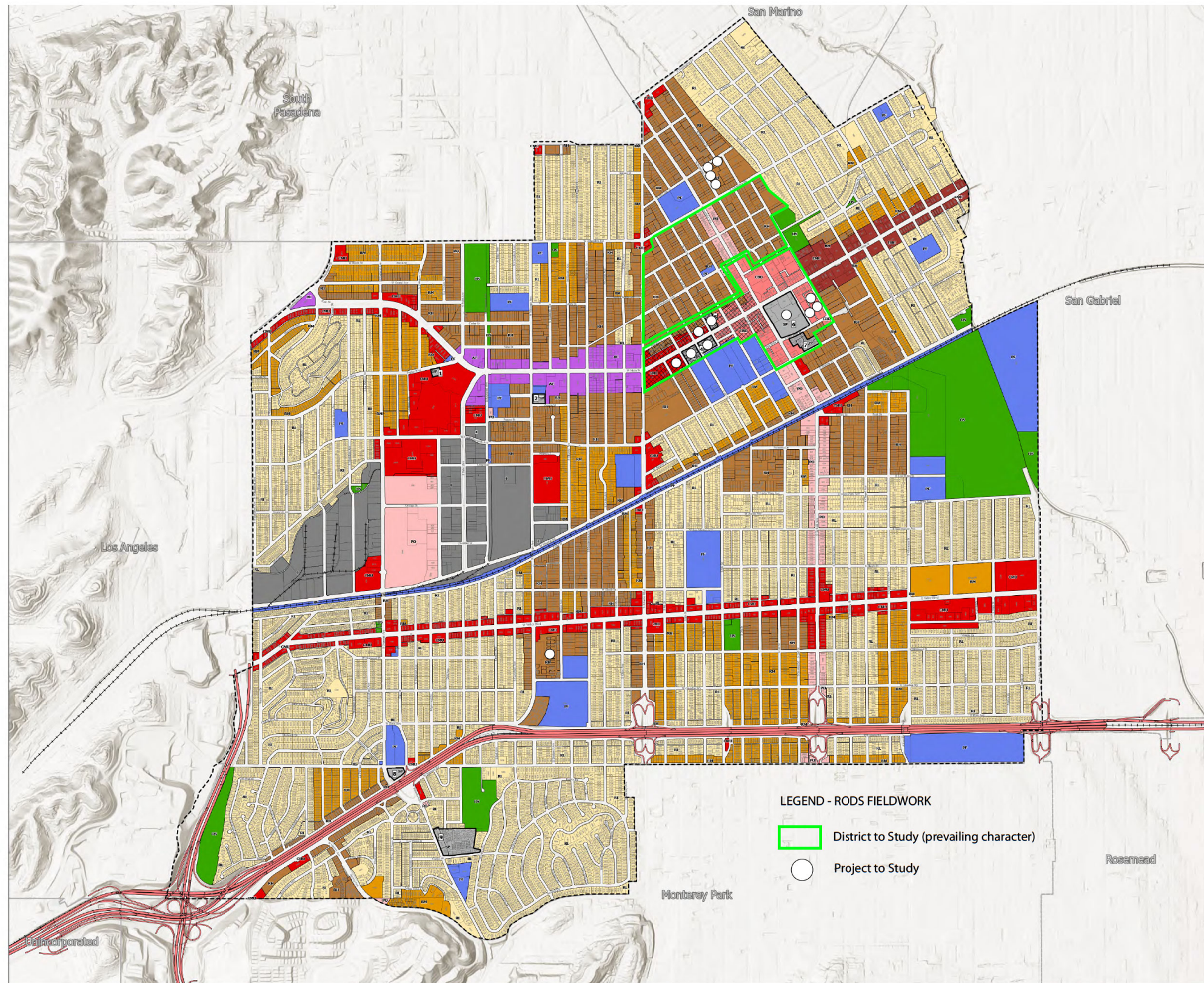

City of Alhambra Zoning Map April 2025

MAP FEATURES

- City Boundary Specific Plan
- Boundary
- Railroad
- Freeway
- Ramp

ZONING DESIGNATION

- RL - Residential Low Density
- RM - Residential Medium Density
- RH - Residential High Density
- PO - Professional Office
- CBD - Central Business District
- CMU - Commercial Mixed Use
- EMC - East Main Commercial
- AC - Automotive Commercial
- SP - Specific Plans
- I - Industrial
- PF - Public Facilities
- OS - Open Space

OVERLAY DISTRICTS

- West Main Corridor

SPECIFIC PLANS

- 2300 Poplar Boulevard Specific Plan
- Marengo and Acacia Specific Plan
- Alhambra 5th and Main Specific Plan
- Alhambra Pacific Plaza - 300 West Main Street Specific Plan
- Castla de Zen Specific Plan
- Alhambra Place Specific Plan
- Alhambra - 100 Bay State Street Specific Plan
- 2500 West Hellman Avenue Specific Plan
- 2400 South Fremont Avenue Specific Plan

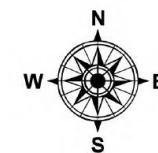

0 0.25 0.5 Miles

Maps and data are to be used for reference purposes only. Map features are approximate, and are not necessarily accurate to surveying or engineering standards. The City of Alhambra makes no warranty or guarantee as to the content (the source is often third party), accuracy, timeliness, or completeness of any of the data provided, and assumes no legal responsibility for information contained in this map. Any use of this product with respect to accuracy and precision shall be the sole responsibility of the user.

Base map and data from City of Alhambra Planning Division. Direct all inquiries to the City of Alhambra Planning Division at (626) 570-5034 or at planning@alhambra.gov.



Appendix E: SGVCOG Regional Objective Design Standards Research Memorandum

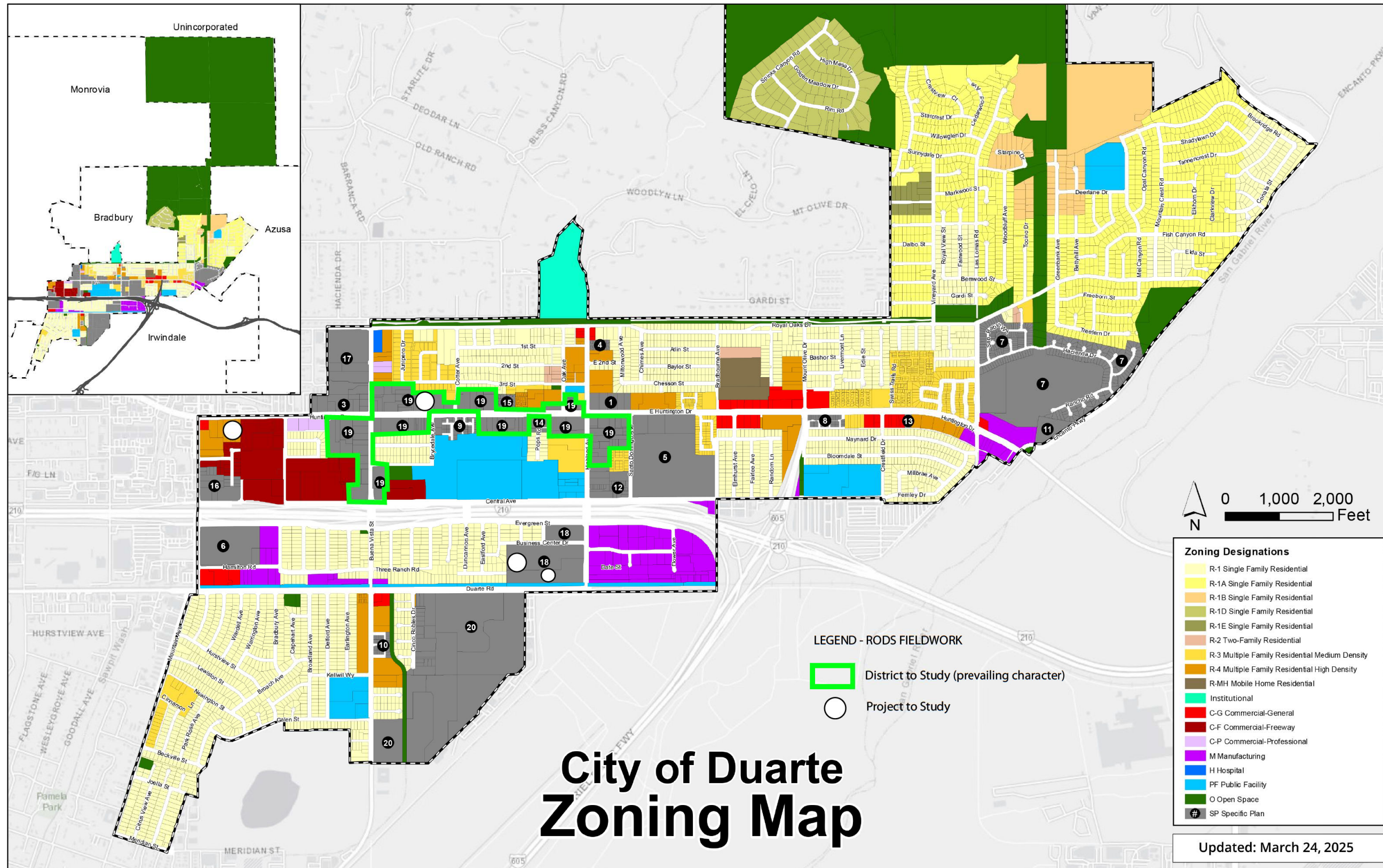

Appendix E: SGVCOG Regional Objective Design Standards Research Memorandum

LEGEND - RODS FIELDWORK

- District to Study (prevailing character)
- Project to Study

Figure 1-1 Land Use Map

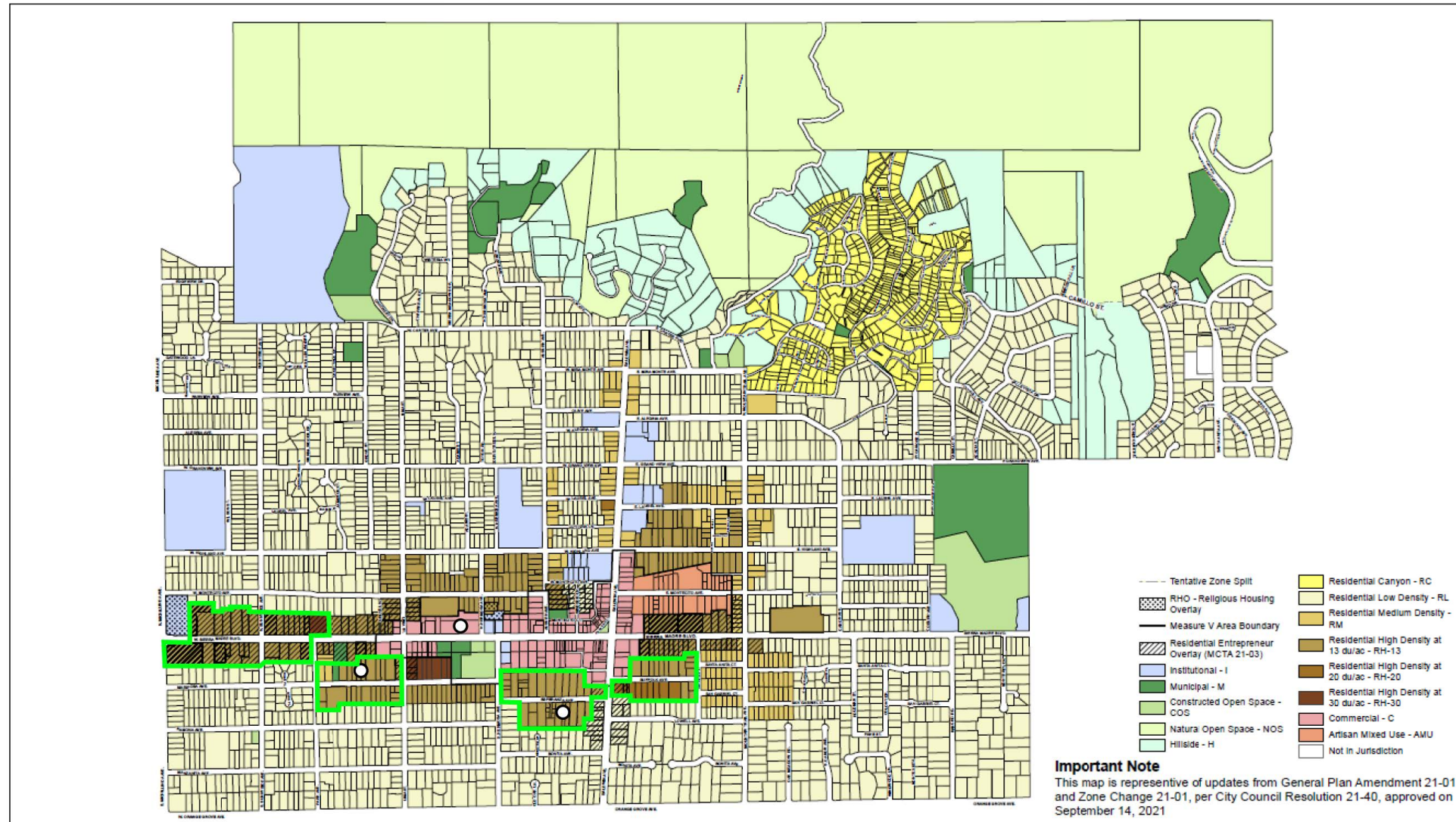

City of Sierra Madre Land Use Map Including Housing Element Updates



Appendix E: SGVCOG Regional Objective Design Standards Research Memorandum

Memo of ODS | The Arroyo Group SGV
COG Objective Design Standards
25 September 2025



EXHIBIT D

ODS FIELDWORK CHECKLIST

The intention of this document is to capture prevalent and community defining architectural features to align with upcoming design standards. Attach photos for important features.

District
Main St (area around Garfield and just west of garfield)
City: Alhambra

Immediate Observations	Approximate Age of Building	Improvements / Renovations	Overall Condition	Historical Relevance
	1920's - 1950's	Renovations made to many/ façade improvements	Overall Good / Fair	yes

Height	Number of Stories	Estimated Height
	Older Buildings 1-2	15'-20'

Setbacks	Front	Side	Side	Rear
	0'	0'	0'	0'

Building Form	Roof Geometry	Overall Geometry	Building Breaks
	Flat	Boxy	no/ 1 passthrough

Architectural Style	Clearly Discernible Style	Primary Features Associated With Style
	American Commercial	flat roofs, brick, storefront windows, tight commercial spaces

Building Type	Typology
	Single story commercial

Defining Characteristics	Primary Street Facing Features
	Store front windows, recessed entry, corner entry, awnings, Prominent commercial signage

Fenestration and Openings	Doors	Windows	Other Openings
	Street Facing, Recessed, glass storefront doors	Large store front windows	not clear

Material	Wall	Color	Roof	Hardscape
	Brick/ Stucco	Multi earth tones, shades of beige, brick	tar and gravel	Sidewalk, Cement planters

Landscape Features	Primary Features	Hardscape Features	Softscape Features
	Planters both built in and pots, palm trees	material change/ color	plants, flowers, trees (fair amount)

Primary Elevation	Primary Features	Articulation	Frontage Type	Other
	Signage, parapets, awnings, brick/stucco façades	Minimal variations in storefront spacing, signage scale, and material changes	Shopfront/forecourt	walkable, car-oriented, active commercial/dining

General Notes:

Appendix E: SGVCOG Regional Objective Design Standards Research Memorandum

ODS FIELDWORK CHECKLIST

The intention of this document is to capture prevalent and community defining architectural features to align with upcoming design standards. Attach photos for important features.

District
Main St
City: Alhambra

Immediate Observations	Approximate Age of Building	Improvements / Renovations	Overall Condition	Historical Relevance
	2000's	Well Maintained	Good / Fair	No

Height	Number of Stories	Estimated Height
	Newer Buildings 1-5	20'-60'

Setbacks	Front	Side	Side	Rear
	0'	0'	0'	0'

Building Form	Roof Geometry	Overall Geometry	Building Breaks
	Varied Flat/ Gable Towers	Rectangular geometrical language, some buildings have geometry interrupted by massing components or modular systems	no

Architectural Style	Clearly Discernible Style	Primary Features Associated With Style
	Spanish Colonial Revival, Art Deco, American Commercial	Arches, Clay tile roofs, stucco walls

Building Type	Typology
	Podium, Single

Defining Characteristics	Primary Street Facing Features
	Ground Floor Retail, Large Store front windows, recessed entry, corner entry, awnings, Prominent commercial signage

Fenestration and Openings	Doors	Windows	Other Openings
	Street Facing, Recessed, Corner Entries	Large store front windows	na

Material	Wall	Color	Roof	Hardscape
	Stucco	Multi earth tones, shades of beige, brick	Clay tile when visible	Passsthroughs though building breaks

Landscape Features	Primary Features	Hardscape Features	Softscape Features
	Street trees	none consistent	Plantings (very minimal)

Primary Elevation	Primary Features	Articulation	Frontage Type	Other
	Awning, Signage, balcony, window and opening variation	Color variance on facades, plane changes, varied heights, tower uses, fenestration, roof line breaks along parapets	Shopfront	podium parking access from side streets

General Notes:

ODS FIELDWORK CHECKLIST

The intention of this document is to capture prevalent and community defining architectural features to align with upcoming design standards. Attach photos for important features.

District
RH ZONE
City: Alhambra

Immediate Observations	Approximate Age of Building	Improvements / Renovations	Overall Condition	Historical Relevance
	late 1960's-early 2000's	na	Fair – minor staining, aged stucco	No

Height	Number of Stories	Estimated Height
	2 stories above tuck-under garage level.	25'

Setbacks	Front	Side	Side	Rear
	Generally 10-15'	5-10'	5-10'	assume 10-15'

Building Form	Roof Geometry	Overall Geometry	Building Breaks
	Predominantly gable roofs	Long, narrow massings, box structures	Symmetrical facades with central driveway recesses; repetitive architectural rhythms.

Architectural Style	Clearly Discernible Style	Primary Features Associated With Style
	Spanish Colonial Revival-inspired, some craftsman	Stucco walls, red tile roofs, arched windows, balconies, Pitched Roof/ Front Porch/

Building Type	Typology
	Walk-Up / Courtyard / Podium Hybrid, residential units above garages with central access driveways.

Defining Characteristics	Primary Street Facing Features
	Projecting gables, arched window bays, recessed central driveways with garages.

Fenestration and Openings	Doors	Windows	Other Openings
	Street Facing, neutral color	Front: multi-pane arched windows; Sides: rectangular sliding	Not Clear

Material	Wall	Color	Roof	Hardscape
	Smooth stucco finish, light-colored.	Beiges.	Red clay or concrete tiles/ Shingle	Front Steps, Sloped drive entries, curb cuts, retaining walls near driveways.

Landscape Features	Primary Features	Hardscape Features	Softscape Features
	Shrubs, Grass, Small trees, low maintenance plants	walk way rocks	rocks

Primary Elevation	Primary Features	Articulation	Frontage Type	Other

Appendix E: SGVCOG Regional Objective Design Standards Research Memorandum

ODS FIELDWORK CHECKLIST

The intention of this document is to capture prevalent and community defining architectural features to align with upcoming design standards. Attach photos for important features.

District
Huntington Dr
City: Duarte

Immediate Observations	Approximate Age of Building	Improvements / Renovations	Overall Condition	Historical Relevance
	1950's-1980's	Partial: some repainting, modern signage, minor repairs or remodels	Fair: roof and façades show wear, signage and landscaping are maintained	City Hall?

Height	Number of Stories	Estimated Height
	1,2	15'-20'

Setbacks	Front	Side	Side	Rear
	20'	10'	10'	15'

Building Form	Roof Geometry	Overall Geometry	Building Breaks
	Gable, Low pitch hip	Boxy/ eculidean	none to minimal

Architectural Style	Clearly Discernible Style	Primary Features Associated With Style
	Spanish Colonial	Arches, Clay tile roofs, stucco walls

Building Type	Typology
	Commercial, strip mall, motel apartment

Defining Characteristics	Primary Street Facing Features
	Spanish features, decorative parapet, street/car oriented commercial

Fenestration and Openings	Doors	Windows	Other Openings
	Aluminum/glass storefront, neutral colors	Small to medium, recessed, rectangular	none observed

Material	Wall	Color	Roof	Hardscape
	Stucco, Tile details	Beige / Off-white	Clay tile	Concrete sidewalks, asphalt lots

Landscape Features	Primary Features	Hardscape Features	Softscape Features
	Palm trees, shrubs	Concrete paths, driveways	Grass patches, small hedges

Primary Elevation	Primary Features	Articulation	Frontage Type	Other
	Recessed entries, canopy	Minimal depth or plane changes, typical articulation coming from overhangin pitch of roof or some sort of parapet feature	Commercial Storefront, Parking lots	podium parking access off main street

General Notes:
walkable, strip mall, small-town, typical spanish style homes and commerical buildings, some ranch style/townhome

ODS FIELDWORK CHECKLIST

The intention of this document is to capture prevalent and community defining architectural features to align with upcoming design standards. Attach photos for important features.

District
Esperanza Ave/Suffolk Ave
City: Sierra Madre

Immediate Observations	Approximate Age of Building	Improvements / Renovations	Overall Condition	Historical Relevance
	1950's-1980's	Minimal, some repainting, possible rennovations	Fair: overall well kept, signs od age but maintained well	possible

Height	Number of Stories	Estimated Height
	2	20'-25'

Setbacks	Front	Side	Side	Rear
	15'	5'	5'	not clear

Building Form	Roof Geometry	Overall Geometry	Building Breaks
	Gable,	Boxy/ eculidean	breaks in cases for some townhome style homes

Architectural Style	Clearly Discernible Style	Primary Features Associated With Style
	Spanish Colonial / Ranch Style	Arches, Clay tile roofs, stucco walls Brick base, shingled upper façade, symmetrical fenestration

Building Type	Typology
	Apartment (2-story)/ multi-family residential

Defining Characteristics	Primary Street Facing Features
	Walkways/steps, street oriented doors, windows, planting, driveways visible, dense evergreen screening

Fenestration and Openings	Doors	Windows	Other Openings
	Typical residential front doors (varied windows)/ some cases iron gate	Small to medium, sliders/double hung	none observed

Material	Wall	Color	Roof	Hardscape
	Stucco, brick	Beige / Off-white/ blues	Clay tile/ Shingle	Concrete sidewalks, Walkways, Steps, Driveways

Landscape Features	Primary Features	Hardscape Features	Softscape Features
	Hedges, Trees, Lawns	Concrete paths, driveways, Steps, Walkways	Lawn strips, roses, bushes

Primary Elevation	Primary Features	Articulation	Frontage Type	Other
	Flat façade with central entry, raised yards, brick and material change on façade	Minimal plane change, Some Articulation with balconies and gable protrutions	Stoop, Yard	

Appendix E: SGVCOG Regional Objective Design Standards Research Memorandum

Memo of ODS | The Arroyo Group
 SGV COG Objective Design Standards
 25 August 2025



EXHIBIT E

ODS FIELDWORK CHECKLIST

The intention of this document is to capture prevalent and community defining architectural features to align with upcoming design standards. Attach photos for important features.

Project
 116 Mclean St similar façade to 630 stoneman, simpler in detail as far as projections and greening
 City: Alhambra

Immediate Observations	Approximate Age of Building	Improvements / Renovations	Overall Condition	Historical Relevance
	2000's	maintained no significant changes noticed	Good, Maintained façade and landscaping	No

Height	Number of Stories	Estimated Height
	2	25'-30'

Setbacks	Front	Side	Side	Rear
	20'	10'	10'	10'

Building Form	Roof Geometry	Overall Geometry	Building Breaks
	Gable	Boxy	between homes

Architectural Style	Clearly Discernible Style	Primary Features Associated With Style
	Spanish	Red clay roof tiles, arched entries, stucco and stone veneer

Building Type	Typology
	Townhouse

Defining Characteristics	Primary Street Facing Features
	entry stoop projection, gables, landscaped walkways, symmetrical units

Fenestration and Openings	Doors	Windows	Other Openings
	Street facing arched dark wood, decorative glass	multi pane, recessed symmetrical	not clear

Material	Wall	Color	Roof	Hardscape
	Stucco with stone veneer	Warm beige with earth tone	Clay Tile	Concrete drive, steps, retaining walls, gate

Landscape Features	Primary Features	Hardscape Features	Softscape Features
	Shrubs, hedges, trees	Walkways/ steps, planters	Flower beds, low hedges, ground cover wood chips

Primary Elevation	Primary Features	Articulation	Frontage Type	Other
	Arched entries, symmetrical windows, tile rooflines	Plane changes, use of recess and projection in the vertical elements	Stoop	1/2 subterranean parking access off main street

Evaluation:
Strengths: Appropriate openings for the Spanish architectural style
Weaknesses: High planters/landscaping percentage reducing usability, Lacking in ornamentation or detail, e.g. wrought iron, Position of the open space is a little too open to the street; could have recessed entry, trellis element, or more enclosed with buildings. Lack of privacy.

Appendix E: SGVCOG Regional Objective Design Standards Research Memorandum

ODS FIELDWORK CHECKLIST

The intention of this document is to capture prevalent and community defining architectural features to align with upcoming design standards. Attach photos for important features.

Project
102 Mclean St
City: Alhambra

Immediate Observations	Approximate Age of Building	Improvements / Renovations	Overall Condition	Historical Relevance
	2000's	New/ well maintained	Good / well maintained	No

Height	Number of Stories	Estimated Height
	2	25'

Setbacks	Front	Side	Side	Rear
	10'	5-10'	5-10'	5'-10'

Building Form	Roof Geometry	Overall Geometry	Building Breaks
	Gable	Rectilinear geometrical language, repeating elements, rectangular blocks with linear modulation.	between homes

Architectural Style	Clearly Discernible Style	Primary Features Associated With Style
	Craftsman	Pitched Roof/ Front Porch/ Tapered Columns/ Lap Siding

Building Type	Typology
	Townhouse

Defining Characteristics	Primary Street Facing Features
	Porches/ gables/ window, columns/ walkway

Fenestration and Openings	Doors	Windows	Other Openings
	Street Facing, neutral color	multi pane, recessed symmetrical	not clear

Material	Wall	Color	Roof	Hardscape
	Lap Siding	Shades of beige	Shingle	Front Steps, stone veneer

Landscape Features	Primary Features	Hardscape Features	Softscape Features
	Shrubs, hedges	material change/ color	Flower beds, low hedges, ground cover wood chips

Primary Elevation	Primary Features	Articulation	Frontage Type	Other
	Gable details, columns stone veneer, almost arcade like porch windows and door façade over very symmetrical and organized	Upper floors stepped back from façade, Plane changes, varied heights, tower use, fenestration	Porch/ Stoop	1/2 subterranean parking access off main street

Evaluation:
Strengths: Clear Craftsman style, second level pop-outs, exposed gable beams, detailed gable transitions, tapered porch posts, brick piers with caps, white corner trim, consistent window and corner detailing, subterranean parking, driveway median softens apron, landscape buffer at patios
Weaknesses: Shallow or faux porches lacking weather protection, unactivated center courtyard, faux porches not functional, 6x6 or 8x8 planters (underutilized)

ODS FIELDWORK CHECKLIST

The intention of this document is to capture prevalent and community defining architectural features to align with upcoming design standards. Attach photos for important features.

Project
1419 Benito Ave
City: Alhambra

Immediate Observations	Approximate Age of Building	Improvements / Renovations	Overall Condition	Historical Relevance
	2010's	New Development	Good	No

Height	Number of Stories	Estimated Height
	3	35'-40'

Setbacks	Front	Side	Side	Rear
	15'	5-10'	5-10'	10'

Building Form	Roof Geometry	Overall Geometry	Building Breaks
	Gable, hipped	Boxy/ Vertical	Recessed entries and balconies at each level; façade steps back at upper floors

Architectural Style	Clearly Discernible Style	Primary Features Associated With Style
	Contemporary spanish	Stucco, clay tile accents, arched entries, iron balcony railings, stone veneer

Building Type	Typology
	Walk-up, Townhouse/ multi-family

Defining Characteristics	Primary Street Facing Features
	Balconies, arched recessed entries, alternating materials (stucco & stone), small private patios

Fenestration and Openings	Doors	Windows	Other Openings
	Street-facing, solid, earth-tone, recessed	Flush and recessed, white-framed, double-hung & sliding	Recessed balconies, vent openings

Material	Wall	Color	Roof	Hardscape
	Stucco and stone veneer cladding	Beige, tan, natural stone	Clay tile	Walkways, entry steps, raised planters

Landscape Features	Primary Features	Hardscape Features	Softscape Features
	Small trees, structured hedges	Concrete walkways, raised walls	Grass, low shrubs, low maintenance planting

Primary Elevation	Primary Features	Articulation	Frontage Type	Other
	Covered balconies, arched entries, stone/stucco contrast	Varied planes, recessed and protruding elements, textured materials	Porch, yard, balcony	Low garden walls, separated unit entries, no visible utility elements

Evaluation:
Strengths: Sufficient building modulation, shed roof at primary entry with arched opening, decorative ironwork and awnings compatible with Spanish style, consistent use of Spanish elements like tile vents, arched openings, single-leaf wood entry door
Weaknesses: very repetitive with minimal variation across 900 ft block, no public access or breaks along frontage, scattered and disjointed layout, weak corner definition, ineffective third-story setback, lacks base/middle/top organization, repetitive square modules create monotonous rhythm, heavy and overwhelming cinder block and split-face walls, no clear frontage for unit entries, oversized cornices and window details, unbalanced porch covers, inconsistent application of Spanish style, lacks asymmetry and shape variety, underscaled window shutters

Appendix E: SGVCOG Regional Objective Design Standards Research Memorandum

ODS FIELDWORK CHECKLIST

The intention of this document is to capture prevalent and community defining architectural features to align with upcoming design standards. Attach photos for important features.

Project
630 Stoneman
City: Alhambra

Immediate Observations	Approximate Age of Building	Improvements / Renovations	Overall Condition	Historical Relevance
	2000's	New/ well maintained	Good	No

Height	Number of Stories	Estimated Height
	2	25'-30'

Setbacks	Front	Side	Side	Rear
	20'	5'-10'	5'-10'	5'-10'

Building Form	Roof Geometry	Overall Geometry	Building Breaks
	Gable	Boxy	between homes

Architectural Style	Clearly Discernible Style	Primary Features Associated With Style
	Spanish	Red clay roof tiles, arched entries, stucco and stone veneer

Building Type	Typology
	Townhouse

Defining Characteristics	Primary Street Facing Features
	entry stoop projection, gables, landscaped walkways, symmetrical units

Fenestration and Openings	Doors	Windows	Other Openings
	Street facing arched dark wood, decorative glass	multi pane, recessed symmetrical	not clear

Material	Wall	Color	Roof	Hardscape
	Stucco with stone veneer	Warm beige with earth tone	Clay Tile	Concrete drive, steps, retaining walls, gate

Landscape Features	Primary Features	Hardscape Features	Softscape Features
	Shrubs, hedges, trees	Walkways/ steps, planters	Flower beds, low hedges, ground cover wood chips

Primary Elevation	Primary Features	Articulation	Frontage Type	Other
	Arched entries, symmetrical windows, tile rooflines	Plane changes, use of recess and projection in the vertical elements	Stoop	1/2 subterranean parking access off main street

Evaluation:
<p>Strengths: Provides architectural details that are consistent with the selected Spanish style, including tile decorative vents, arched openings, and a single-leaf solid wood door at the primary entry.</p> <p>Weaknesses: Proportions are a bit off; cornices are too large and visually dominant. Porch cover and window details are oversized and appear unbalanced relative to the building massing. There is a lack of consistency in the application of the architectural style—Spanish architecture typically embraces asymmetry and a mix of shapes, which is not well-reflected here. The overall composition of the façade feels disorganized. Window shutters are not appropriately scaled to the window openings.</p>

ODS FIELDWORK CHECKLIST

The intention of this document is to capture prevalent and community defining architectural features to align with upcoming design standards. Attach photos for important features.

Project / District (circle one): Casita de Zen Specific Plan
Street (for districts): West Main Street & North 3rd Street
City: Alhambra

Immediate Observations	Approximate Age of Building	Improvements / Renovations	Overall Condition	Historical Relevance
		Semi-private interior wall finish improvements 2015	Good	No Historical Relevance

Height	Number of Stories	Estimated Height
	5	55 - 60 ft.

Setbacks	Front	Side	Side	Rear
	1 foot	1 to 3 feet (street side)	0 feet (interior side)	6 feet

Building Form	Roof Geometry	Overall Geometry	Building Breaks
	Gable & Hipped roofs	Vertical	1 to 3-foot depth for every 10 feet @ ground level 6-foot depth for every 10 to 20 feet @ 2nd - 4th floors 3-foot depth for every 30 feet @ 5th floor

Architectural Style	Clearly Discernible Style	Primary Features Associated With Style
	Spanish Revival	Arched openings, heavy roofing, upper level balconies, ironwork, wide range of opening sizes, emphasis on overall structural mass

Building Type	Typology
	Podium with garage and commercial at ground level and residential and courtyard at upper levels

Defining Characteristics	Primary Street Facing Features
	Open trellis structures, decorative railing, fence, and grilles, decorative gable vents, and corner rotunda

Fenestration and Openings	Doors	Windows	Other Openings
	Street facing or arcade facing, black and grey aluminum door frame, double swing at street level and sliding at balconies	3x4 sliding, 2x casements, and garden windows, flush with detailed reveals or thickened surround, proportioned per interior program	Graden window and prefabricated garage grille/railing for fresh air intake.

Material	Wall	Color	Roof	Hardscape
	Smooth stucco, 1" stucco reveals, course belt trim between 4th and 5th floor, stucco columns	Grey, tan, and white walls; green roof fascias; black and brown ironwork, brown wood elements, and black and grey windows and doors	Red slate roof tiles with half-round edges. Soffit underside of roof eave (boxed)	Scored and colored concrete

Landscape Features	Primary Features	Hardscape Features	Softscape Features
	Vines on courtyard trellis, perimeter landscape screening, and shrub/green walls	Concrete walkways and driveway	Gravel in landscape areas at ground level

Primary Elevation	Primary Features	Articulation	Frontage Type	Other
	Pop-out balconies, corner rotunda, void at upper levels due to open courtyard.	Material Changes at windows and at different floor levels, Changes in Plane vertically due to balconies, stairwells, courtyards, or primary entry points, Proportions of Openings to Wall is larger at ground level than upper levels.	Shopfront and residential lobby, Arcade to parking and retail/restaurants, and covered dining areas, and open parking garage at ground level	Decorative fencing, awning, exterior seating, art feature, and exterior light fixtures, Utility Location at roof

Evaluation:
<p>Strengths: Residential portion of facade seems good, level of modulation may be appropriate</p> <p>Weaknesses: Not consistent enough between podium & residential area (no common language of forms) corner turret may be the wrong move; not large enough to be usable on the ground floor & not enough separation; moved the entry from its intended location at the corner, roof is too busy, Would have been better to break massing on Main - crowds street too much?</p>

Appendix E: SGVCOG Regional Objective Design Standards Research Memorandum

ODS FIELDWORK CHECKLIST

The intention of this document is to capture prevalent and community defining architectural features to align with upcoming design standards. Attach photos for important features.

Project / District (circle one): Alhambra Pacific Plaza - 300 West Main Street Specific Plan
 Street (for districts): West Main Street & South 3rd Street & 4th Street
 City: Alhambra

Immediate Observations	Approximate Age of Building	Improvements / Renovations	Overall Condition	Historical Relevance
	2016	Commerical signage and awning improvements	Good	No Historical Relevance

Height	Number of Stories	Estimated Height
		5 - 55 - 60 ft.

Setbacks	Front	Side	Side	Rear
	3-15 foot	3-6 feet (street side)	3-6 feet (street side)	25 feet

Building Form	Roof Geometry	Overall Geometry	Building Breaks
	Shed & Hipped roofs	Vertical with mass podium	3 to 15-foot depth for every 15 feet @ ground level 2-foot depth for every 10 to 20 feet @ upper floors

Architectural Style	Clearly Discernible Style	Primary Features Associated With Style
	Mediterranean	Arched openings, barrel roofing, upper level balconies, heavy base, emphasis on wall and window details

Building Type	Typology
	Podium with garage and commercial at ground level and residential and courtyard at upper levels

Defining Characteristics	Primary Street Facing Features
	Trellis structures, decorative railing, decorative trim and course belt, and corner rotunda

Fenestration and Openings	Doors	Windows	Other Openings
	Street facing or Arcade facing, Silver aluminum door frame, Double swing at street level and sliding at balconies	3x4 to 4x5 sliding and 2x3 single-hung, flush with stucco surround trim, organized in a serial rythum	Square openings for garage fresh air intake, and 15-20 foot tall storefront windows with grids

Material	Wall	Color	Roof	Hardscape
	Smooth stucco, stone base that wraps around the ground floor, 1" stucco reveals, course belt trim, cornice trim, stucco band & decorative trim	Grey, tan, and white walls; red awnings; black ironwork, green/brown trellis, and white windows and door frames	Terracotta-colored Barrel roof tiles with half-round edges. Soffit underside of roof eave (boxed)	Scored concrete

Landscape Features	Primary Features	Hardscape Features	Softscape Features
	Potted plants along public sidewalk	Concrete walkways and driveway	Planting at ground level

Primary Elevation	Primary Features	Articulation	Frontage Type	Other
	Recessed balconies, corner rotunda (octagon shape), side entrance plaza / public amenities space	Material Changes at storefront base and building modulations, Changes in Plane due to balconies, grouped windows, and primary entry points. Proportions of Openings to Wall is larger at ground level then upper levels.	Storefront, Public plaza with Arcade to parking and residential lobby, and uncovered dining areas, and open parking garage at ground level facing the rear	Decorative railing, fabric awnings and metal canopies, public seating/art feature, and exterior light fixtures, Utility Location at roof

Evaluation:
<p>Strengths: More attention to storefront details, awnings, bulkhead, datum line at top of the podium, Clear base/middle/top, Stepback helps, Intent with trim and material change - around archways, vertical modules</p> <p>Weaknesses: Plazas are not as useable (shallow)</p>

ODS FIELDWORK CHECKLIST

The intention of this document is to capture prevalent and community defining architectural features to align with upcoming design standards. Attach photos for important features.

Project / District (circle one): Plaza on Main
 Street (for districts): West Main Street & South 4th Street & 5th Street
 City: Alhambra

Immediate Observations	Approximate Age of Building	Improvements / Renovations	Overall Condition	Historical Relevance
	1926 (305 W Main St) 1999 (369 W Main St)	Storefronts & Bulkhead renovations	Moderate	305 W Main St - No Historical Relevance 369 W Main St - No Historical Relevance

Height	Number of Stories	Estimated Height
		5 - 55 ft.

Setbacks	Front	Side	Side	Rear
	0 - 6 inches	1 feet (street side)	0 feet (interior side)	0 feet (facing alley)

Building Form	Roof Geometry	Overall Geometry	Building Breaks
	Flat roofs	Staggered Mass / Modular	1-5-foot depth for every 15 feet @ ground level 1-foot depth for every 20 feet @ upper floors

Architectural Style	Clearly Discernible Style	Primary Features Associated With Style
	Artdeco (305 W Main St) Contemporary (369 W Main St)	Geometric forms and details, symmetrical building mass (305 W Main St) Arched openings, geometric shapes (369 W Main St)

Building Type	Typology
	Horizontal simple block (305 W Main St) Podium with garage and commercial at ground level and residential with central courtyard (369 W Main St)

Defining Characteristics	Primary Street Facing Features
	Simple horizontal railing, fabric awnings, and rounded corner entrance

Fenestration and Openings	Doors	Windows	Other Openings
	Street facing, Horizontal arcade, Double swing storefronts at street level and sliding at balconies	3x4 fixed, vertical serial rythem (305 W Main St) 3x4 - 4x4 sliding, (369 W Main St)	Square openings for garage fresh air intake, and 15-20 foot tall storefront windows with grids

Material	Wall	Color	Roof	Hardscape
	Stucco and Reflective Tile, stucco reveals, iron work	Red, grey, tan, and brown walls; blue awnings; red and brown ironwork, white windows and door frames	Flat roofs, parapet with no ornamentation, simple cornice	Concrete

Landscape Features	Primary Features	Hardscape Features	Softscape Features
	Vines growing on metal trellis	Concrete walkways and driveway	Planting at ground level

Primary Elevation	Primary Features	Articulation	Frontage Type	Other
	Fabric awnings (305 W Main St) Recessed balconies, arched openings, curved corner facade (369 W Main St)	Material Changes at podium and organized horizontally, Changes in Plane due to balconies and upper floors which are stepped back, Proportions of Openings to Wall is low	Large spans of Storefront, Arched openings at entry, breeze way at corner	Geometrical railing and grilles and fabric awnings, Utility Location at roof

Evaluation:
<p>Strengths: Landscaping frames paseo, open paseo into site. Storefronts at paseo are less framed Clear material transition base/middle/top Four stories no setback Transition into plaza</p> <p>Weaknesses: Bulkhead couldve been a more textured material. Overall stucco on ground floor is not too bad, because it has diferent shades and lines through it. Roughly 100' wide simple box form on Main St is good, but 150' simple box form on 3rd St may be too long.</p>

Appendix E: SGVCOG Regional Objective Design Standards Research Memorandum

ODS FIELDWORK CHECKLIST

The intention of this document is to capture prevalent and community defining architectural features to align with upcoming design standards. Attach photos for important features.

Project / District (circle one): Alhambra 5th and Main Specific Plan
 Street (for districts): West Main Street & South 4th Street & 5th Street
 City: Alhambra

Immediate Observations	Approximate Age of Building	Improvements / Renovations	Overall Condition	Historical Relevance
	2012	Semi-private interior wall finish improvements	Good	No Historical Relevance

Height	Number of Stories	Estimated Height
	4	50- 55 ft.

Setbacks	Front	Side	Side	Rear
	1 - 15 feet	1 ft (street side)	1 feet (interior side)	15 feet

Building Form	Roof Geometry	Overall Geometry	Building Breaks
	Hipped and Flat roofs	Combination of Vertical and Box mass	1-foot depth for every 10 feet @ ground level 1 to 6-foot depth for every 10 feet @ upper floors

Architectural Style	Clearly Discernible Style	Primary Features Associated With Style
	Mediterranean	Arched openings, barrel roofing, upper level balconies, heavy base, emphasis on column, window, and roof details

Building Type	Typology
	Semi-Podium with ground floor commercial storefronts and residential lobby entrances

Defining Characteristics	Primary Street Facing Features
	Corner entry, side plaza, landscape buffer between street and sidewalk, focal landscape features

Fenestration and Openings	Doors	Windows	Other Openings
	Commercial doors are Street Facing, residential are facing courtyard, black aluminum door / storefront frames	30"x48" hung windows, flush with stucco surround trim, proportions are small and similar throughout	Garage openings with metal grille

Material	Wall	Color	Roof	Hardscape
	Stucco walls, course belt, cornice, bracket details, surround trim	Multi-color, color focused on window groups, different color for base	Red clay tile, flat parapet roofs	Scored concrete and pavers

Landscape Features	Primary Features	Hardscape Features	Softscape Features
	Potted plants and ground shrubs	Scored concrete and brick pavers at courtyard	Shrubs on dirt at side yards

Primary Elevation	Primary Features	Articulation	Frontage Type	Other
	Metal canopies along sidewalks, recessed and extended balconies, metal awnings	Material change at the base stucco to smooth concrete, Changes in Plane at corners and at open plaza, Proportions of Openings to Wall is well balanced	Shopfront along the street sides, Residential Lobby and covered porch at courtyard, and at grade covered parking in the rear	Prefabricated decorative fencing, railing, and grilles, Utility Location at roof, No public seating, Courtyard semi-private seating

General Notes:
 North side, between 4th and 3rd Streets, Feels very bottom-heavy, No consistency between podium and upper levels, Lack of trim/changing material at balconies, Retail not inviting: lacks articulation, simple columns, low transparency, too dar.
 Corner residential units need more transparency and exposure to both sides, Arcade dimension is too narrow

ODS FIELDWORK CHECKLIST

The intention of this document is to capture prevalent and community defining architectural features to align with upcoming design standards. Attach photos for important features.

Project / District (circle one): Alhambra Regency Plaza
 Street (for districts): West Main Street & South 5th Street & 6th Street
 City: Alhambra

Immediate Observations	Approximate Age of Building	Improvements / Renovations	Overall Condition	Historical Relevance
	2004	No improvements or renovations	Good	No Historical Relevance

Height	Number of Stories	Estimated Height
	5	55-60 ft.

Setbacks	Front	Side	Side	Rear
	0 to 20 feet	1 to 2 feet (street side)	1 to 3 feet (street side)	10 feet

Building Form	Roof Geometry	Overall Geometry	Building Breaks
	Gable & Flat roofs	Staggered Mass / Modular	10-foot depth for every 10 to 20 feet @ ground level 6-foot depth for every 10 feet @ 2nd - 4th floors 1-foot depth for every 10 to 20 feet @ 5th floor

Architectural Style	Clearly Discernible Style	Primary Features Associated With Style
	Contemporary	Geometric building forms, symmetrical building mass, emphasized grid system

Building Type	Typology
	Podium with commercial and garage at ground level, residential and amenities on top

Defining Characteristics	Primary Street Facing Features
	Arcade, breeze way, side and corner plaza area, fixed seating, and metal trellis structures

Fenestration and Openings	Doors	Windows	Other Openings
	Street Facing for commercial and residential lobby, double doors for commercial and sliding for balconies, silver color, aluminum	3x5 and 5x5 sliding with fixed bottom, flush with trim top, Proportion is similar in height varies in width	Arched fixed upper window and arched garage openings

Material	Wall	Color	Roof	Hardscape
	Stucco and tile wall finish, course belt and Cornice	Multi-color with white, pink, and brown walls, white trim, blue railing, grilles and trellis	Flat parapet roof and staning seam metal roof on gable, white cornice and blue metal roof	Scored colored concrete, diamond shape

Landscape Features	Primary Features	Hardscape Features	Softscape Features
	Focal planters at plaza, potted plants, and ground level planting	Scored colored concrete with decorative geometric design	Planters at grade

Primary Elevation	Primary Features	Articulation	Frontage Type	Other
	Horizontal trim details on walls and columns, covered arcade and open plaza walkways, trellis structures, and recessed balconies	Material Changes at bulkhead level, Changes in Plane at plaza and openings, Proportions of Openings to Wall are well-balanced	Shopfront along sidewalks and facing the plaza, residential lobby at arcade, at grade parking located at the rear	Prefabricated fence and grilles for garage, Utility Location on the roof, and public seating with canopy

Evaluation:
Strengths: Consistent use of shapes, between 5th and 6th St, color palette is pastels — of its time, planter buffer at the landscaping makes sense + outdoor dining (only uses that work)
Weaknesses: Too much stepping back — overly complex, not needed along the whole block, reads as a four-story building, could have more awnings, colored or stamped concrete to differentiate the plaza from the sidewalk.

Appendix E: SGVCOG Regional Objective Design Standards Research Memorandum

ODS FIELDWORK CHECKLIST

The intention of this document is to capture prevalent and community defining architectural features to align with upcoming design standards. Attach photos for important features.

Project Solana/ Esperanza
1750 Fasana Rd
City: Duarte

Immediate Observations	Approximate Age of Building	Improvements / Renovations	Overall Condition	Historical Relevance
	2020's	New	Good	No

Height	Number of Stories	Estimated Height
	5	60'-65'

Setbacks	Front	Side	Side	Rear
	5'-10' (landscaped)	0'-5'	0'-5'	20' / not clear

Building Form	Roof Geometry	Overall Geometry	Building Breaks
	Flat	Boxy/ Vertical modulation	Massing articulation with breaks, open space breaks along façade

Architectural Style	Clearly Discernible Style	Primary Features Associated With Style
	Contemporary/ Urban modern	Metal panel cladding, exposed steel framing, large storefront glazing

Building Type	Typology
	Podium Apartment (Leasing/amenity at ground, parking behind)

Defining Characteristics	Primary Street Facing Features
	varied cladding textures, deep entry recesses, retail-scale glazing, balconies, Large Signage

Fenestration and Openings	Doors	Windows	Other Openings
	Commercial-grade glass double doors at leasing office, other entry to amenity and courtyards along street	Modern windows, flush and recessed; some double and some singular	Recessed balconies, no visible skylights

Material	Wall	Color	Roof	Hardscape
	Metal siding, Cement	Multi-color scheme (dark gray, beige, burgundy red, black trim)	Tar and gravel	Concrete sidewalk, curb ramps, integrated tree wells

Landscape Features	Primary Features	Hardscape Features	Softscape Features
	Small street trees, structured landscaping	Concrete sidewalks, tree grates	Decorative grasses, shrubs, small planters near entry

Primary Elevation	Primary Features	Articulation	Frontage Type	Other
	Metal/wood vertical siding, large glass lobby, balconies	Material/plane changes, offset balconies, vertical massing breaks	Lobby	Large signage, directional signage to parking

Evaluation:
<p>Strengths: Clear and even distribution of building block widths, consistent use of steel/industrial aesthetic, massing is broken up at an appropriate rhythm, clear horizontal datum and window organization, emphasized building corners with stark colors and corner balconies, wraparound human-scale canopy at corners, complementary and well-coordinated color and materials palette, large freeway sign hides parking, ground-floor open spaces on some frontages, sufficient landscape buffer between private patios and sidewalk.</p> <p>Weaknesses: Building crown lacks roofline breaks or modulation, individual unit entries at ground level lack articulation and character, frontages are dominated by solid privacy walls, unclear how frontage types were incorporated, overall building height lacks variation.</p>

ODS FIELDWORK CHECKLIST

The intention of this document is to capture prevalent and community defining architectural features to align with upcoming design standards. Attach photos for important features.

Project
1413 Huntington Dr
City: Duarte

Immediate Observations	Approximate Age of Building	Improvements / Renovations	Overall Condition	Historical Relevance
	2000's	New	Good	No

Height	Number of Stories	Estimated Height
	4	45'-55'

Setbacks	Front	Side	Side	Rear
	5'-8'	0'-5'	0'-5'	15'-20'

Building Form	Roof Geometry	Overall Geometry	Building Breaks
	Flat	Boxy	60' break

Architectural Style	Clearly Discernible Style	Primary Features Associated With Style
	Contemporary	Brick/stucco contrast, symmetrical facade, defined window framing, cornice details

Building Type	Typology
	Podium (mixed-use or multi-family over parking)

Defining Characteristics	Primary Street Facing Features
	Tall street-level retail windows, balconies, pedestrian-friendly entrance, vertical brick columns

Fenestration and Openings	Doors	Windows	Other Openings
	Street-facing glass entries (retail)	Repetitive double-hung style, flush	Balconies on 2nd & 3rd floors

Material	Wall	Color	Roof	Hardscape
	Stucco and brick	Multi-color (tan, olive green, brown)	Tar and gravel	sidewalk, curb planters

Landscape Features	Primary Features	Hardscape Features	Softscape Features
	Street trees in grates	Concrete sidewalks, curb planters	Small planting beds (minimal)

Primary Elevation	Primary Features	Articulation	Frontage Type	Other
	Brick columns, balconies, defined window cornices	Material changes, plane shifts at balconies, color banding	Shopfront	podium parking access off main street

Evaluation:
<p>Strengths: Use of decorative paving materials to highlight plazas and commercial frontage, Use of multiple materials that are durable, Variation of metal canopies over storefronts that are human scale and consistent with the overall building character. Use of cornice or crown details that create horizontal breaks in the building mass while adding detail to the façade. Horizontal articulation/modules are OK, plaza is a good size and user-friendly with a central public art element, commercial and parking entrances are clearly indicated, lacks upper-floor modulation and roofline variation</p> <p>Weaknesses: Lack of depth and little definition defined by recessed openings and building façade modulation. Parking garage entrance takes up a lot of usable storefront space. Parking garage should be located on the secondary or tertiary frontage.</p>

Appendix E: SGVCOG Regional Objective Design Standards Research Memorandum

ODS FIELDWORK CHECKLIST

The intention of this document is to capture prevalent and community defining architectural features to align with upcoming design standards. Attach photos for important features.

Project
1200 Olivia Court
City: Duarte

Immediate Observations	Approximate Age of Building	Improvements / Renovations	Overall Condition	Historical Relevance
	2010's	New	Good	No

Height	Number of Stories	Estimated Height
	3	35'-45'

Setbacks	Front	Side	Side	Rear
	15'	0'-5'	0'-5'	20'? (measured on google maps, could be less just built to 20' for car access)

Building Form	Roof Geometry	Overall Geometry	Building Breaks
	Gable	Euclidean with projections	Breaks for courtyard and garage on lot

Architectural Style	Clearly Discernible Style	Primary Features Associated With Style
	Mediterranean / Spanish Revival	Red tile roof, arched entryway, stucco walls, shuttered windows, simple ornamentation

Building Type	Typology
	Walk-Up Townhomes (Garages Below)

Defining Characteristics	Primary Street Facing Features
	Repetitive gable roofs, decorative shutters, entry arches, stucco cladding, private garage entries

Fenestration and Openings	Doors	Windows	Other Openings
	Residential-scale entry doors, garage doors	Multi-pane horizontal windows; some projecting bay windows; small punched windows	Small arched entry recess; no balconies or skylights visible

Material	Wall	Color	Roof	Hardscape
	Smooth stucco exterior	Cream / beige with darker accents	Red clay tile	Paver driveways, concrete sidewalk, garage access

Landscape Features	Primary Features	Hardscape Features	Softscape Features
	Formal entry landscaping with hedges and sign	Paver driveway, concrete sidewalk	Shrubs, groundcover, small trees, flowering beds

Primary Elevation	Primary Features	Articulation	Frontage Type	Other
	Arched entry, window shutters, projecting bays	Roof projections, bay windows, recessed entries	at grade entry	Neighborhood signage (OLIVA), minimal fencing

Evaluation:
<p>Strengths: Provides window details consistent with selected architectural style, pop-outs create depth and break up building mass, pop-outs compatible with Spanish architecture, well-distributed elements like iron grilles, awnings, shutters, and attic vents, sufficient landscape and setback buffer at ground-level patios, decorative paving at driveway and walkways, craftsmanship elements and accent points at building corners, consistent application of architectural style, good stoop frontage with landscaping transition, muted earth tones with contrasting trim, variation in modules adds interest, proportional shutters complement window scale, gutters and downspouts used as intentional visual elements</p> <p>Weaknesses: Window color, materials, and grid style are inconsistent with the overall palette, window grid style lacks definition and does not reflect true divided lights</p>

ODS FIELDWORK CHECKLIST

The intention of this document is to capture prevalent and community defining architectural features to align with upcoming design standards. Attach photos for important features.

Project
70 Esperanza Ave
City: Sierra Madre

Immediate Observations	Approximate Age of Building	Improvements / Renovations	Overall Condition	Historical Relevance
	2000's	Landscaping Improvements, Most likely painted	Good, building and landscaping well maintained	no

Height	Number of Stories	Estimated Height
	3	30'-35'

Setbacks	Front	Side	Side	Rear
	20'	5'-10'	5'-10'	5'-10'

Building Form	Roof Geometry	Overall Geometry	Building Breaks
	Gable/Hipped	Boxy	Breaks in massing across unit sections

Architectural Style	Clearly Discernible Style	Primary Features Associated With Style
	Contemporary Traditional	Stone details, white trim, gabled roofs, covered entries, lodge like

Building Type	Typology
	Multifamily/ Townhome

Defining Characteristics	Primary Street Facing Features
	Covered entryway, stone veneer, balconies, well landscaped.

Fenestration and Openings	Doors	Windows	Other Openings
	Glass paneled double door faces drive way loop for lobby, Street-facing, wood for townhomes	Flush, multi-pane windows.	Balconies

Material	Wall	Color	Roof	Hardscape
	Stucco, Stone Veneer, Wood Trim	Shades of olives and green	Shingle	Concrete sidewalks, Walkways, Driveways/ drive loop, drive pavers, Stone Veneer

Landscape Features	Primary Features	Hardscape Features	Softscape Features
	Hedges, Trees, bushes	Walkways, Stone along column bases, Stone Veneer wall at driveway	Lawn, flower beds, planter areas

Primary Elevation	Primary Features	Articulation	Frontage Type	Other
	Covered entries, balconies, varied windows	Variations in massing, recessed balconies, contrast in materials, trim color, plane shifts, Town homes use projections nicely	Lobby	Subterranean parking access from west

Evaluation:
<p>Strengthen: Building staggers or steps back to reduce overall scale from the public right-of-way, appropriate building details for style such as course belt trim, recessed windows, wide overhangs, and exposed structural beams, use of multiple materials such as stone, stucco, and wood appropriate for the style, large covered porch emphasizes building entry, setbacks attempt to reduce perceived massing, project includes elements that reference style despite varied surrounding context</p> <p>Weaknesses: overall building scale feels oversized relative to neighborhood, setbacks only partially effective in reducing massing, porte-cochere creates an inactive and unengaging frontage, project exceeds low-rise character of surrounding area, front setback is too deep and weakens relationship to street, lacks a clear frontage type to primary building entry for pedestrians</p>

Appendix E: SGVCOG Regional Objective Design Standards Research Memorandum

ODS FIELDWORK CHECKLIST

The intention of this document is to capture prevalent and community defining architectural features to align with upcoming design standards. Attach photos for important features.

Project
405 Mariposa Ave
City: Sierra Madre

Immediate Observations	Approximate Age of Building	Improvements / Renovations	Overall Condition	Historical Relevance
	Not Clear	Not sure if improved or just maintained.	Good, building and landscaping well maintained	no

Height	Number of Stories	Estimated Height
	2	25'-30'

Setbacks	Front	Side	Side	Rear
	10'-15'	5'-10'	5'-10'	15'

Building Form	Roof Geometry	Overall Geometry	Building Breaks
	Gable/Hipped	Boxy/ Euclidean	Yes

Architectural Style	Clearly Discernible Style	Primary Features Associated With Style
	Spanish Colonial / Ranch Style	Arches, Clay tile roofs, stucco walls

Building Type	Typology
	Multifamily

Defining Characteristics	Primary Street Facing Features
	Arched porch, decorative tiled stairs, balconies, varied landscaping

Fenestration and Openings	Doors	Windows	Other Openings
	Arched wood door	Flush, Symmetrical	Balconies

Material	Wall	Color	Roof	Hardscape
	Stucco	Off-white or cream	Clay tile	ADA Ramps, Concrete sidewalks, Walkways, Steps, Driveways

Landscape Features	Primary Features	Hardscape Features	Softscape Features
	Hedges, Trees, courtyard	Brick/Tiled Paths, Decomposed Granite, Ramp	Trees, shrubs, planters, flowering plants

Primary Elevation	Primary Features	Articulation	Frontage Type	Other
	Arcade walkways, corner feature, awnings, courtyard	Recessed arches, varied wall planes, symmetry with small shifts	Porch/Stoop	Driveway access with gate to the west.

Evaluation:
<p>Strengthen: Appropriately scaled for the neighborhood, building features consistent with Spanish style such as decorative railings, stone door trim, and exposed rafter tails, significant setback with ample landscaping between patios and sidewalk, decorative paving at driveway and walkways, multifamily building appears like single-family which integrates into the neighborhood, well-articulated massing, strong frontage appeal that engages the street, well-maintained landscaping enhances curb presence, integrated ramp and stair access, authentic Spanish elements like archways and tiled roofs</p> <p>Weaknesses: Lacks a clear frontage type to private units or common space such as a stoop or defined entry feature</p>

ODS FIELDWORK CHECKLIST

The intention of this document is to capture prevalent and community defining architectural features to align with upcoming design standards. Attach photos for important features.

Project
245 W Sierra Madre Blvd
City: Sierra Madre

Immediate Observations	Approximate Age of Building	Improvements / Renovations	Overall Condition	Historical Relevance
	2010's	Not sure if improved or just maintained.	Good, building and landscaping well maintained	no

Height	Number of Stories	Estimated Height
	2	25'-30'

Setbacks	Front	Side	Side	Rear
	10'	10'	10'	10'

Building Form	Roof Geometry	Overall Geometry	Building Breaks
	Gable/Hipped	Boxy/ Horizontal	yes, courtyard

Architectural Style	Clearly Discernible Style	Primary Features Associated With Style
	Spanish Colonial / Ranch Style	Arches, Clay tile roofs, stucco walls

Building Type	Typology
	Mixed Use / Senior Living

Defining Characteristics	Primary Street Facing Features
	Covered arcade, signage, awnings, corner tower, balconies, iron railings, decorative tile

Fenestration and Openings	Doors	Windows	Other Openings
	White framed, glazed, double	Multi-pane, flush with stucco, white trim	not clear

Material	Wall	Color	Roof	Hardscape
	Stucco	Off-white or cream	Clay tile	ADA Ramps, Concrete sidewalks, Walkways, Steps, Driveways

Landscape Features	Primary Features	Hardscape Features	Softscape Features
	Hedges, Trees, courtyard	Concrete paths, driveways, Steps, Walkways	Trees, shrubs, planters, flowering plants

Primary Elevation	Primary Features	Articulation	Frontage Type	Other
	Arcade walkways, corner feature, awnings, courtyard	Inset windows, color breaks, plane changes	Gallery, Porch	

Evaluation:
<p>Strengthen: Well-balanced breaks in the roofline and roof modulation, sufficient level of detail to window trim and grouping, usable and semi-private arcade that is visually appropriate and provides screening, appropriately screened utilities and equipment using planting or low walls, good level of detail with appropriate use of Spanish Colonial style, well-executed arcade helps conceal building depth and massing, open space along frontage breaks up façade length, effective use of landscaping and fencing to define open spaces while maintaining privacy, standpipes are well screened with landscaping and low walls</p> <p>Weaknesses: Railing lacks decoration consistent with Spanish style, window grilles lack depth and definition due to grids being located between the glass rather than on the exterior, window depth is lacking and could benefit from more shadow and articulation</p>

Appendix E: SGVCOG Regional Objective Design Standards Research Memorandum

Exhibit F	Objective Design Standards this Project Exemplifies	Link to picture examples of successful projects
<p>Successful Projects that Exemplify Specific Objective Design Standards (Include name of project, full project address)</p> <p>801 East Main Housing Project</p>	<p>Objective Design Standards this Project Exemplifies (Include explanation of why the project is successful, for each identified design standard)</p> <p>Site Planning and Access - locating vehicular access along the non-major high-traffic streets, locating open common spaces at the corners of the site to maximize human interaction and clear visuals to site amenities, provided covered entries to each unit, creating connectivity for pedestrians where openings or voids along the building facade occur and invite patrons to separate spaces on the project. Building Modulation & Articulation - buildings present balconies (covered and uncovered) that create relief and breaks in the building mass, presents various openings, decorative railing and notches, awnings, and corbels that articulates the facade, and is designed at a lower human scale along the public sidewalk with 1 - 1 1/2 stories or setback from the property line with well-design landscaping buffer.</p>	<p>49 dwelling units ranging in size from 2 to 4 bedrooms. As required by the State Housing Element Law, the City rezoned the project site to allow residential development as a use by-right for projects that dedicate at least 20% of their total units as affordable to lower income households</p> <p>801-817 East Main Street and 17-25 North Granada Avenue Alhambra, CA</p>
<p>Mariposa Affordable Housing Development</p>	<p>Materials, Finishes, and Color - the building provides at least 3 different wall cladding materials or colors such as brick and siding panels of various colors. Focusing heavier materials at the base of the building creating a logical foundation and changing siding colors where modulation occurs on the upper floors. Finishes are authentic with a natural appearance and texture. Parking structure - location of at grade parking is oriented towards a parking lot and alley, and away from the main thoroughfare. Parking structure is integrated into the overall design and introduces a series of focus planting at columns.</p> <p>Entries - location of residential entries are more private in nature with potted landscaping, isolated canopy, signage, and transparent. Verses retail and restaurant entrances which are presented with larger storefronts, cohesive overhang/awning, thickened bulkhead and columns that create a durable foundation along a high pedestrian traffic area. Parking Structures - present a panelized system on the exterior façade that screens parking while adding an architectural element to the elevation. These perforated panels provide shade to the interior of the parking structure and create a visual appeal through lighting.</p>	<p>A mix of 1- and 2- bedroom units for a total of 40 units in a 5-story building with on-site support services</p> <p>Mariposa Affordable Housing Development Alhambra</p>
<p>Monterey Bay Square</p>	<p>Building Modulation and Articulation - presents a combination of roof forms at different heights that is compatible with its architectural style. Roof supports / brackets are well-detailed and consistent throughout. Upper stories are setbacks to create a more human scale design with a differentiation in design among each story. Materials, Finishes, and Color - At least 3 different materials are used on the project including stone, lap siding, and stucco with complementary colors. Materials are logically organized where stone is focused along the base of the building, and siding and stucco are well-distributed throughout.</p>	<p>A mixed-use residential and commercial center that consists of ground-floor retail and restaurant, and five floors of condominium residential units (62 units total) above. There will also be a second building consisting of a 7-level parking structure with a ground floor restaurant unit. (built)</p> <p>Monterey Bay Square Alhambra, CA</p>
<p>123 South Marguerita Ave</p>	<p>Architectural Elements - roof lines broken at regular intervals, balcony materials are consistent with the architectural style, freeway visible signage</p> <p>Articulation - four-sided architecture, difference in materials from first two floors to upper floors, recessed balconies at top of building</p> <p>Architectural Corner Element - red color at corner</p> <p>Materials - balconies look to be steel or metal, Roof materials complement the materials and colors of the façades, color are varied across facade, standing seam metal at the key corner helps the entry stand out.</p> <p>Open Space Amenities - open space includes BBQ grills, pizza oven, fire pit, dog park, pool jacuzi, gathering space, private phone call rooms, business room</p>	<p>A three-story, four-unit apartment complex. The complex is configured as a duplex, and features landscaping, and communal space in the form of common open space. The Craftsman style architecture can be seen in the Hardie-siding, roof brackets, shaped rafter tails and hung windows.</p> <p>123 South Marguerita Avenue Alhambra, CA</p>
<p>Solana (Duarte), 1750 Fasana Rd, Duarte, CA 91010</p>		<p>https://www.solanaduarte.com/gallery/</p>

Exhibit F	Objective Design Standards this Project Exemplifies	Link to picture examples of successful projects
<p>Successful Projects that Exemplify Specific Objective Design Standards (Include name of project, full project address)</p> <p>Paragon at Old Town Apartments, 700 S Myrtle Ave, Monrovia, CA 91016</p>	<p>Objective Design Standards this Project Exemplifies (Include explanation of why the project is successful, for each identified design standard)</p> <p>Base/Middle/Top - use of brick material and horizontal datum to distinguish retail ground floor from upper residential floors</p> <p>Building Breaks - pedestrian courtyards off the side streets are 50' deep building setbacks off the street (not full breaks)</p> <p>Architectural Corner Elements - pedestrian courtyard at corner, floating corner element at south corner on myrtle (3D architectural element)</p> <p>Materials - in some places ground floor materials/color differentiation between ground floor v upper floors, awnings along Myrtle street frontage, podium parking materials match some sides of the building, similar color/materials as development to northeast</p> <p>Design of Parking/Elements to conceal parking structure use - it looks like a apartment building (aka fake windows), however, it is clearly parking, landscaping around the parking podium, entrances located furthest from the Myrtle intersection</p>	<p>https://www.paragonatoldtown.com/apartments/ca/monrovia/photo-gallery</p>
<p>Avalon Monrovia, 825 S Myrtle Ave, Monrovia, CA 91016</p>	<p>Building Form - 360 degree design, the inset balconies reduce bulk/massing</p> <p>Materials and Colors - very monolithic white to light cream; white brick material used along the corner and also along the ground floor, but not the entire ground floor, smooth texture on all other surfaces of building, balconies seem to be steel/metal, some of the balconies have awnings that aren't fabric, parking podium looks semi-similar to the building in color</p> <p>Entries - Corner entrance is most prominent, with high transparency and tower.</p> <p>Stepbacks - fronting on Myrtle the top floor is stepbacked off the street, matching Paragon to north</p>	
<p>Colorado Blvd/Primrose Ave NE Corner (Monrovia), 151 W Colorado Blvd, Monrovia, CA 91016</p>	<p>Frontage Types - frontyard/porch type, accommodated in a variety of ways in both the block-scale and house-scale portions of the development</p> <p>Large site designed as two separate developments</p> <p>Articulation - Western townhomes designed as individually distinguished row homes (e.g. San Francisco)</p>	
<p>New Development North of APU citrus college station (The Promenade), 839 Orchid Way, Azusa, CA 91702</p>	<p>Public Realm/Landscaping - An entire townhome development formed around a central traffic circle and boulevards with landscaped paths/medians</p> <p>Architectural Style - Seems like the townhomes follow a Spanish colonial architectural style. Materials include brick at the ground floor level of some of the buildings, smooth white, cream, yellow, light brown color, medium brown accents. Mission bell type lights. Small variations between buildings and larger variations between blocks to avoid extreme monotony.</p>	
<p>Aream Monrovia</p>	<p>An interesting shape for the development, a triangle</p> <p>Wrap development/hidden parking</p> <p>large green space setback from santa anita wash with dog spaces and a pool</p>	
<p>Citrus Walk, 137 E. Italia Street, Covina, CA 91723</p>	<p>Frontage Type (yard?) - Seems there are ground floor porches fenced in along Italia St, and there are also individual entrances linked to these porches. These porches are flat to the ground.</p> <p>Material and Color - Colors in the development are orange, blue, green, grey. Articulation highlights individual units.</p> <p>Building Type (live/work) - Rowhouses, but The corner townhome has a rear facing balcony, and this townhome also features a ground floor commercial use. Also the townhomes fronting on Citrus Ave have ground floor commercial uses, and inset balconies.</p>	
<p>Citrus Village (City Ventures), 1009 N Citrus Ave, Covina, CA 91722</p>	<p>Pedestrian Connectivity - Stone material to slow traffic at entry, pedestrian connection to central green space</p> <p>Frontage (patio) - There are walled in no-step patios at the ground floor level fronting on Citrus Ave. These patios lead to individual unit entries.</p>	

Appendix E: SGVCOG Regional Objective Design Standards Research Memorandum

Exhibit F			
Successful Projects that Exemplify Specific Objective Design Standards (Include name of project, full project address)	Objective Design Standards this Project Exemplifies (Include explanation of why the project is successful, for each identified design standard)	Link to picture examples of successful projects	
Monterey Station Apartments, 120 N Garey Ave, Pomona, CA 91767 80 North Raymond Condominiums, 80 N Raymond Ave, Pasadena, CA 91103 Marv's Place, 143 Mar Vista Ave, Pasadena, CA 91106	Material and Color - Colors are lime, white, light brown, dark brown, dark grey/navy. Along Garey Ave, brick material along 2nd and 3rd stories, smooth white texture on ground floor, metal siding texture at fourth floor. Corner - No corner element architecturally, but there is public art. Parking mimics building detail		
Mission Meridian Village, 727-809 Meridian Ave, South Pasadena, CA 91030 Park View, 645 E Union St, Pasadena, CA 91101	Residential yard frontage in multifamily Large Site - breaks up large site into two separately designed projects, and residential site into smaller-scaled buildings Building Orientation - buildings oriented to maximize spaces and views from street, house-scale view Architectural Style - Craftsman style townhomes transitions to single family neighborhood Frontage - porch frontage and vertical separation from street provide privacy Material and Color - coherent application of Spanish architectural style, white stucco, blue trim, terra cotta roof, and cream balcony pilasters Corner - corner open space/dining gesture with tower and public art at top Stepback - horizontal datum and stepback from street frontage at top floor delineates top of building		
Trio Apartments, 44 N Madison Ave, Pasadena, CA 91101	Open Space - penetrable public open space		

Exhibit F				
Successful Projects that Exemplify Specific Objective Design Standards (Include name of project, full project address)	Objective Design Standards this Project Exemplifies (Include explanation of why the project is successful, for each identified design standard)	Link to picture examples of successful projects	Image of Project	
801 East Main Housing Project	Site Planning and Access - locating vehicular access along the non-major high-traffic streets, locating open common spaces at the corners of the site to maximize human interaction and clear visuals to site amenities, provided covered entries to each unit, creating connectivity for pedestrians where openings or voids along the building facade occur and invite patrons to separate spaces on the project. Building Modulation & Articulation - buildings present balconies (covered and uncovered) that create relief and breaks in the building mass, presents various openings, decorative railing and notches, awnings, and cornices that articulates the facade, and is designed at a lower human scale along the public sidewalk with 1 - 1 1/2 stories or setback from the property line with well-design landscaping buffer.	801-817 East Main Street and 17-26 North Granada Avenue Alhambra, CA		49 dwelling units ranging in size from 2 to 4 bedrooms. As required by the State Housing Element Law, the City rezoned the project site to allow residential development as a use by-right for projects that dedicate at least 20% of their total units as affordable to lower income households
Mariposa Affordable Housing Development	Materials, Finishes, and Color - the building provides at least 3 different wall cladding materials or colors such as brick and siding panels of various colors. Focusing heavier materials at the base of the building creating a logical foundation and changing siding colors where modulation occurs on the upper floors. Finishes are authentic with a natural appearance and texture. Parking structure - location of at grade parking is oriented towards a parking lot and alley, and away from the main thoroughfare. Parking structure is integrated into the overall design and introduces a series of focus planting at columns. Entries - location of residential entries are more private in nature with potted landscaping, isolated canopy, signage, and transparent. Verses retail and restaurant entrances which are presented with larger storefronts, cohesive overhang/awning, thickened bulkhead and columns that create a durable foundation along a high pedestrian traffic area. Parking Structures - present a panelized system on the exterior facade that screens parking while adding an architectural element to the elevation. These perforated panels provide shade to the interior of the parking structure and create a visual appeal through lighting.	Mariposa Affordable Housing Development Alhambra, CA		A mix of 1- and 2- bedroom units for a total of 40 units in a 5-story building with on-site support services
Monterey Bay Square	Building Modulation and Articulation - presents a combination of roof forms at different heights that is compatible with its architectural style. Roof supports / brackets are well-detailed and consistent throughout. Upper stories are setbacks to create a more human scale design with a differentiation in design among each story. Materials, Finishes, and Color - At least 3 different materials are used on the project including stone, lap siding, and stucco with complementary colors. Materials are logically organized where stone is focused along the base of the building, and siding and stucco are well-distributed throughout.	Monterey Bay Square Alhambra, CA		A mixed-use residential and commercial center that consists of ground-floor retail and restaurant, and five floors of condominium residential units (62 units total) above. There will also be a second building consisting of a 7-level parking structure with a ground floor restaurant unit. (built)
123 South Marguerita Ave	Architectural Elements - roof lines broken at regular intervals, balcony materials are consistent with the architectural style, freeway visible signage Articulation - four-sided architecture, difference in materials from first two floors to upper floors, recessed balconies at top of building Architectural Corner Element - red color at corner Materials - balconies look to be steel or metal, Roof materials complement the materials and colors of the façades, color are varied across facade, standing seam metal at the key corner helps the entry stand out. Open Space Amenities - open space includes BBQ grills, pizza oven, fire pit, dog park, pool/jacuzzi, gathering space, private phone call rooms, business room	123 South Marguerita Avenue Alhambra, CA		A three-story, four-unit apartment complex. The complex is configured as a duplex, and features landscaping, and communal space in the form of common open space. The Craftsman style architecture can be seen in the Hardie-siding, roof brackets, shaped rafter tails and hung windows.
Solana (Duarte), 1750 Fasana Rd, Duarte, CA 91010	Base/Middle/Top - use of brick material and horizontal datum to distinguish retail ground floor from upper residential floors Building Breaks - pedestrian courtyards off the side streets are 50' deep building setbacks off the street (not full breaks) Architectural Corner Elements - pedestrian courtyard at corner, floating corner element at south corner on myrtle (3D architectural element) Materials - in some places ground floor materials/color differentiation between ground floor v upper floors, awnings along Myrtle street frontage, podium parking materials match some sides of the building, similar color/materials as development to northeast Design of Parking/Elements to conceal parking structure use - it looks like an apartment building (aka fake windows), however, it is clearly parking, landscaping around the parking podium, entrances located furthest from the Myrtle intersection	https://www.solanaduarte.com/gallery/		
Paragon at Old Town Apartments, 700 S Myrtle Ave, Monrovia, CA 91016	Building Form - 360 degree design, the inset balconies reduce bulk/massing Materials and Colors - very monolithic white to light cream; white brick material used along the corner and also along the ground floor, but not the entire ground floor, smooth texture on all other surfaces of building, balconies seem to be steel/metal, some of the balconies have awnings that aren't fabric, parking podium looks semi-similar to the building in color Entries - Corner entrance is most prominent, with high transparency and tower.	https://www.paragonatoldtown.com/apartments/ca/monrovia/photo-gallery		
Avalon Monrovia, 825 S Myrtle Ave, Monrovia, CA 91016	Stepbacks - fronting on Myrtle the top floor is stepbacked off the street, matching Paragon to north			

Appendix E: SGVCOG Regional Objective Design Standards Research Memorandum











Exhibit F Successful Projects that Exemplify Specific Objective Design Standards (Include name of project, full project address)	Objective Design Standards this Project Exemplifies (Include explanation of why the project is successful, for each identified design standard)	Link to picture examples of successful projects	Image of Project
Colorado Blvd/Primrose Ave NE Corner (Monrovia), 151 W Colorado Blvd, Monrovia, CA 91016	Frontage Types - frontyard/porch type, accommodated in a variety of ways in both the block-scale and house-scale portions of the development Large site designed as two separate developments Articulation - Western townhomes designed as individually distinguished row homes (e.g. San Francisco)		
New Development North of APU citrus college station (The Promenade), 839 Orchid Way, Azusa, CA 91702	Public Realm/Landscaping - An entire townhome development formed around a central traffic circle and boulevards with landscaped paths/medians Architectural Style - Seems like the townhomes follow a Spanish colonial architectural style. Materials include brick at the ground floor level of some of the buildings, smooth white, cream, yellow, light brown color, medium brown accents. Mission bell type lights. Small variations between buildings and larger variations between blocks to avoid extreme monotony.		
Areum Monrovia	An interesting shape for the development, a triangle Wrap development/hidden parking large green space setback from santa anita wash with dog spaces and a pool		
Citrus Walk, 137 E. Italia Street, Covina, CA 91723	Frontage Type (yard?) - Seems there are ground floor porches fenced in along Italia St, and there are also individual entrances linked to these porches. These porches are flat to the ground. Material and Color - Colors in the development are orange, blue, green, grey. Articulation highlights individual units. Building Type (live/work) - Rowhouses, but the corner townhome has a rear facing balcony, and this townhome also features a ground floor commercial use. Also the townhomes fronting on Citrus Ave have ground floor commercial uses, and inset balconies.		
Citrus Village (City Ventures), 1009 N Citrus Ave, Covina, CA 91722	Pedestrian Connectivity - Stone material to slow traffic at entry, pedestrian connection to central green space Frontage (patio) - There are walled in no-step patios at the ground floor level fronting on Citrus Ave. These patios lead to individual unit entries.		
Monterey Station Apartments, 120 N Garey Ave, Pomona, CA 91767	Material and Color - Colors are lime, white, light brown, dark brown, dark grey/navy. Along Garey Ave, brick material along 2nd and 3rd stories, smooth white texture on ground floor, metal siding texture at fourth floor. Corner - No corner element architecturally, but there is public art.		
80 North Raymond Condominiums, 80 N Raymond Ave, Pasadena, CA 91103	Parking mimics building detail		
Marv's Place, 143 Mar Vista Ave, Pasadena, CA 91106	Residential yard frontage in multifamily		

Exhibit F Successful Projects that Exemplify Specific Objective Design Standards (Include name of project, full project address)	Objective Design Standards this Project Exemplifies (Include explanation of why the project is successful, for each identified design standard)	Link to picture examples of successful projects	Image of Project
Mission Meridian Village, 727-809 Meridian Ave, South Pasadena, CA 91030	Large Site - breaks up large site into two separately designed projects, and residential site into smaller-scaled buildings Building Orientation - buildings oriented to maximize spaces and views from street, house-scale view Architectural Style - Craftsman style townhomes transitions to single family neighborhood Frontage - porch frontage and vertical separation from street provide privacy		
Park View, 645 E Union St, Pasadena, CA 91101	Material and Color - coherent application of Spanish architectural style, white stucco, blue trim, terra cotta roof, and cream balcony pilasters		
Trio Apartments, 44 N Madison Ave, Pasadena, CA 91101	Corner - corner open space/dining gesture with tower and public art at top Stepback - horizontal datum and stepback from street frontage at top floor delineates top of building Open Space - penetrable public open space		

External Image Sources

External Source List for Images and Graphics:

All images and graphics not identified in this list are the property of either The Arroyo Group of ONYX Architects.

Page 2:

Top left image: Paragon at Old Town (<https://www.paragonatoldtown.com/apartments/ca/monrovia/neighborhood>)

Page 4:

Top map graphic: San Gabriel Valley Council of Governments (<https://www.sgvkog.org/about>)

Page 7:

Top left image: TrioAptsPasadena (<https://www.trioaptpasadena.com>)

Bottom left image: Zillow.com (https://www.zillow.com/homedetails/1015-N-Citrus-Ave-Covina-CA-91722/122236404_zpid/)

Top right image: Solana at Duarte Station (<https://www.solanaduarte.com/gallery/>)

Bottom right image: Trulia.com (<https://www.trulia.com/home/103-n-catalina-ave-pasadena-ca-91106-250338849>)

Page 13:

Top image: Avalon Communities (<https://www.avaloncommunities.com/california/monrovia-apartments/avalon-monrovia/>)

Middle image: ReeceNichols Real Estate (<https://www.reecenichols.com/realestate/details/55527134/117-w-2nd-suite-d-street-stanberry-mo-64489>)

Page 22:

Bottom right image: Loftway (<https://loftway.com/buildings/station-lofts-pasadena/>)

Page 23:

Bottom right image: Gem City Images (<http://www.gemcityimages.com/2021/06/avalon-monrovia.html>)

Page 26:

Bottom right image: Homes.com (<https://www.homes.com/real-estate-agents/mingyang-gao/fh9l7yt/>)

Page 29:

Bottom image: The Cultural Landscape Foundation (<https://www.tclf.org/landscapes/plaza-las-fuentes>)

Page 30:

Top left image: Playavista.com (<https://playavista.com/sustainability-begins-here/>)

Bottom left image: Francis Krahe & Associates (<https://www.fkaild.com/united-states/playa-vista-parks>)

Page 31:

Top left image: National Core (<https://nationalcore.org/communities/marvs-place/>)

Top right image: Playavista.com (<https://playavista.com/>)

Bottom right image: Budzet.krakow.pl (<https://budzet.krakow.pl/>)

Page 32:

Top left image: Ace/121 Gallery (<https://ace121gallery.com/>)

Top right image: Pasadena Star News (<https://www.pasadenastarnews.com/2019/12/30/explore-pasadena-come-for-the-roses-stay-for-the-shopping/>)

Bottom right image: Yelp courtesy of Maruko X

Page 33:

Top left image: Yelp courtesy of Diana G

Bottom left image: Sierra: The Magazine of the Sierra Club (<https://www.sierraclub.org/sierra/green-life/how-green-your-alley>)

Top right image: Excellencepremierrealestate.com (<https://www.excellencepremierrealestate.com/property/virtual-tour/651341447>)

Bottom right image: Zillow (https://www.zillow.com/homedetails/521-Venice-Way-Venice-CA-90291/2056165775_zpid/)

Page 34:

Bottom left image: The Orchard Apartments (Downtown Azusa) (<https://theorchardazusa.com/>)

Top right image: Alexan Marmont (<https://alexanmarmont.com/>)

Bottom right image: Esperanza Apartments Duarte Station (<https://www.livesesperanza.com/>)

Page 35:

Top image: Newman Garrison + Partners - Parking Landing Apartments (<https://nggpartners.com/portfolio-item/park-landing-buena-park-ca/>)

Bottom image: San Diego Tribune (<https://www.sandiegouniontribune.com/2012/05/25/ucsd-building-has-green-roof/>)

Page 36:

Top left image: Solana at Duarte Station (<https://www.solanaduarte.com/gallery/>)

Bottom left image: City of Alhambra (<https://www.alhambra.ca.gov/770/801-817-East-Main-Street-and-17-25-North>)

Bottom right image: Zillow (https://www.zillow.com/homedetails/1015-N-Citrus-Ave-Covina-CA-91722/122236404_zpid/)

Page 37:

Top left image: Loopnet (<https://www.loopnet.com/Listing/216-N-Coronado-St-Los-Angeles-CA/35954028/>)

Bottom left image: Duradeck (<https://duradek.com/vinyl-decking/vinyl-decking-applications/roof-decks/>)

Both right images: Sue Cook, Listing Agent, via Compass (https://www.compass.com/homedetails/280-W-Montecito-Ave-Unit-H-Sierra-Madre-CA-91024/1IUFJL_pid/)



Thursday, April 16, 2026, 5:30 P.M.

City Council Chambers, 232 W. Sierra Madre Blvd.

AMERICANS WITH DISABILITIES ACT

Pursuant to the Americans with Disabilities Act, persons with a disability who require a disability related modification or accommodation in order to participate in a meeting, including auxiliary aids or services, may request such modification or accommodation from the City Clerk at (626) 574-5455. Notification 48 hours prior to the meeting will enable the City to make reasonable arrangements to assure accessibility to the meeting.

PUBLIC COMMENT & ACCESS

The Brown Act provides the public with an opportunity to make public comments at any public meeting. As an alternative, public comment may be submitted by e-mail to publiccomment@sierramadrecal.gov by 3:00PM on the day of the meeting. Emails will be acknowledged at the City Council meeting, filed into public record, and scanned onto the City website for public review.

A copy of the posted agenda and a live video stream of the meeting can be found on the City's website at sierramadrecal.gov, on Foothills Media website at foothillsmedia.org/sierramadre, and broadcast on Government Access Channel 3 (Spectrum).

If you require special assistance to participate in this meeting, please contact the City Clerk's Office at (626) 355-7135 at least 48 hours prior to the meeting.

CODE OF CONDUCT

The purpose of a City Council meeting is to conduct City business. Members of the public that behave in a manner that interrupts or obstructs the City Council's ability to conduct City business may be asked to leave the meeting. Any and all demonstrations which disrupt, interrupt, or obstruct the City Council's ability to conduct City business are prohibited. No signs, posters, or other large objects shall be brought into the Council Chambers or other meeting place if doing so would disrupt, disturb, or otherwise impede the orderly course of the meeting.

1. CALL TO ORDER

Chair Denison called the meeting to order at 5:30 p.m. Director Lin called the roll.

2. ROLL CALL OF PLANNING COMMISSIONERS

Thomas Denison, Chair
Patrick Simcock, Vice Chair
Kevin Brennan, Commissioner
Christine Moran, Commissioner
Yong Yoo, Commissioner

Absent:

Also Present: Clare Lin, Director of Planning and Community Preservation
Aleks Giragosian, City Attorney
Joshua Wolf, Senior Planner
Katelyn Huang, Assistant Planner

3. APPROVAL OF AGENDA

Chair Denison asked for a motion to approve the agenda as presented.

Vice-Chair Simcock made a motion to approve the agenda as presented.

Commissioner Brennan seconded the motion.

Ayes: Chair Denison, Vice-Chair Simcock, Commissioner Brennan, Commissioner Yoo and Commissioner Moran

Noes:

Absent:

Abstain:

The motion to approve the agenda as presented was approved by a unanimous voice vote by all commissioners present.

4. REPORTS FROM CITY COUNCIL LIAISON

Mayor Kristine Lowe provided a brief report thanking city staff and the city attorney for their assistance with planning matters and language updates.

5. PUBLIC COMMENT FOR ITEMS NOT ON THE AGENDA

Any person wishing to speak before the Planning Commission is asked to complete a Speaker Card and provide it to staff prior to the start of the meeting. Speakers are generally limited to three (3) minutes per person and time may not be delegated; any changes to the allotted time will be announced prior to the Public Comment period. Under the Brown Act, the Planning Commission is prohibited from discussing or taking action on any item not listed on the posted agenda.

Addressing the Planning Commission from the audience is not permitted; all comments addressing the Commission must be made from the podium. Only public comment made from the podium will be recognized by the Planning Commission and entered into public record.

Chair Denison opened the podium for public comment on items not on the agenda.

Seeing no one come forward, Chair Denison closed public comment.

6. PUBLIC HEARING

Any person wishing to speak before the Planning Commission on a public hearing item is asked to complete a Speaker Card noting the agenda item number and provide it to staff prior to the start of the public hearing. Separate and apart from the applicant (who may speak longer in the discretion of the Commission) speakers are generally limited to three (3) minutes per person; any changes to the allotted time will be announced prior to the Public Comment period. Under the Brown Act, the Planning Commission is prohibited from discussing or acting on any item not listed on the posted agenda. The applicant may additionally submit rebuttal comments, at the discretion of the Commission.

Following the closure of the public hearing and prior to the final decision, Commissioners shall disclose any ex parte communication that has taken place pertaining to the public hearing item. Planning Commissioners shall also disclose all visits to a site that is the subject of a quasi-adjudicatory proceeding before the Planning Commission. The disclosure will include whether the site visit was organized by staff, upon the invitation of the applicant, or on the Commissioners' own accord. The Commissioner must disclose all information learned from the site visit that is not included in the agenda packet and that informs his or her decision-making.

- a) Tentative Parcel Map (TPM 25-01): Request to subdivide an existing property located at 444 N. Lima Street into three parcels

Assistant Planner Katelyn Huang presented the staff report for the subdivision of a 30,872 square foot property into three parcels. The property is located in the R-1 zone and contains a 1948 single-family dwelling proposed for demolition, which has been deemed ineligible as a historic resource. The proposed parcels measure 8,611, 8,547, and 10,303 square feet, meeting the 7,500 square foot minimum requirement.

Huang noted that seven protected trees exist on the site, with two proposed for removal due to poor health and severe damage. She also stated that a flood control easement exists on parcel 3, and no encroachment permit is required per LA County Public Works.

Staff recommended approval, finding the project consistent with the General Plan, suitable for subdivision, and exempt under Class 15 CEQA. Chair Denison verified that net area calculations apply for floor coverage and noted these lots typically won't need design review due to size constraints.

Adrian Dahl from Dahl Architects presented on behalf of the applicant, explaining that the property owner Steve Riboli lives nearby on Auburn Street and plans for his three children to occupy the future homes. All three homes are planned as two-story structures requiring separate design review permits. Dahl described proposed home sizes and emphasized the intention to preserve the large oak tree by designing the shared driveway around it, while removing only damaged trees.

Community Input

Chair Denison opened the floor for community input for public hearing item a.

Public comments on the project included:

Joe Catalano

480 North Lima Street

Joe Catalano, former planning commissioner and neighboring property owner spoke in strong support of the project, noting its compatibility with his property and expressing hope that an existing concrete block wall would be removed.

Cynthia Loesch

435 Adams Street

Cynthia Lash raised concerns about privacy impacts from the proposed two-story homes. She specifically objected to home number 3 being sited only 24 feet from her property line, arguing this would create direct lines of sight into her backyard and bedroom windows regarding General Plan policy L 6.3.

Guy Bailey

418 N. Lima Street

Guy Bailey supported the subdivision concept but questioned whether the trees proposed for removal were truly in poor condition, suggesting independent verification should be required.

Jennifer Maqueda

118 E. Laurel Avenue Unit C

Jennifer Makeda questioned whether the proposed development would meet future homebuyers' needs for yards and privacy, expressing concern about the townhome-like character of the development.

Deliberation

Commissioners disclosed ex parte communications. Vice Chair Simcock and Commissioner Yoo reported walking the property, while Chair Denison also conducted a site visit. No substantive ex parte contacts occurred.

Commissioners focused on their limited role in reviewing lot splits versus future home designs. Vice Chair Simcock initially asked about conditioning lot approval on design review requirements but was advised by City Attorney Aleks Giragosian that such conditions were inappropriate since no home applications had been submitted.

Commissioner Moran stated there were sufficient findings to split the lot. Vice Chair Simcock agreed, noting the minimum lot size requirements were met and the arborist report provided sufficient evidence for tree removal proposals.

Commissioner Yoo concurred, noting the correction that the large oak tree would be preserved.

Chair Denison emphasized that the commission's role was strictly to evaluate the lot split, not future development, and noted that precedent existed with other three-lot splits on Lima Street.

Commissioner Moran made a motion to approve Tentative Parcel Map (TPM 25-01) as discussed.

Vice-Chair Simcock seconded the motion.

Ayes: Chair Denison, Vice-Chair Simcock, Commissioner Brennan, Commissioner Moran and Commissioner Yoo

Noes:

Absent:

Abstain:

The motion to approve Tentative Parcel Map (TPM 25-01) was passed by majority vote of all commissioners present.

b) Municipal Code Text Amendment (MCTA 26-01) Amending Chapter 17.22 (Accessory Dwelling Units) of Title 17 (Zoning) of the Sierra Madre Municipal Code

Senior Planner Joshua Wolf presented updates to Sierra Madre's ADU ordinance to align with recent state laws and HCD expectations. The update seeks to establish objective standards, resolve internal conflicts, clarify ambiguities, and support housing strategies.

Wolf explained that since the March 19th discussion, staff clarified with HCD that up to four ADUs can be created on a single-family lot. He showed different scenarios with combinations of state-mandated ADUs—like junior, conversion, and new detached ADUs.

Chair Denison and commissioners questioned distinctions between state-mandated and city-permitted ADUs.

Wolf explained city-permitted ADUs adhere to zoning standards, whereas state-mandated ADUs have fewer local regulatory constraints.

Extensive discussion on height and angle plane standards ensued. Wolf demonstrated via visuals that 16-foot ADUs with 4-foot setbacks can fit through thoughtful design and grading, even on sloped lots. He noted that compliance is simpler when property lines are at the higher slope side, while lower side property lines demand innovative design solutions like stepped-back building volumes or strategic grading.

City Attorney Giragosian stated that HCD's new interpretation permitting four ADUs per lot is contentious and unprecedented, lacking support from regional city attorneys. He clarified that angle plane standards can be enforced except for state-mandated ADUs below 800 square feet with 4-foot setbacks.

Wolf summarized additional changes with updated definitions referring to state law, revised parking rules, fire sprinkler requirements, and standards organized by attached or detached

ADUs. The ordinance aims to simplify permitting by combining ADU and building permit reviews, eliminating separate 60-day reviews.

The commission discussed whether to impose a 90-day application abandonment timeline for incomplete applications. Wolf explained current practice involves contacting applicants after one year to determine continuation or abandonment.

Community Input

No public comment was received on the ADU ordinance amendments.

Deliberation

Vice Chair Simcock noted he had reviewed the red-line document and found only minor grammatical issues that could be addressed with staff offline. Commissioners agreed the changes captured their previous discussions appropriately.

Vice-Chair Simcock made a motion to approve Municipal Code Text Amendment (MCTA 26-01) as amended and discussed.

Commissioner Moran seconded the motion.

Ayes: Chair Denison, Vice-Chair Simcock, Commissioner Brennan, Commissioner Moran and Commissioner Yoo

Noes:

Absent:

Abstain:

The motion to approve Municipal Code Text Amendment (MCTA 26-01) was passed by majority vote of all commissioners present.

7. CONSENT CALENDAR

All matters listed under the Consent Calendar are considered to be routine and can be acted on by one roll call vote. There will be no separate discussion of these items unless a member of the Planning Commission requests that a specific item be removed from the Consent Calendar for separate discussion and action.

a) Regular Meeting Minutes of March 19, 2026

CEQA: Not a Project

Recommended Action: Approve

Chair Denison asked the Commission for a motion to approve the March 19, 2026, Meeting Minutes.

Vice-Chair Simcock made a motion to approve the March 19, 2026, Meeting Minutes.

Commissioner Yoo seconded the motion.

Ayes: Chair Denison, Vice-Chair Simcock, Commissioner Brennan, and Commissioner Yoo

Noes:

Absent:

Abstain: Commissioner Moran

The motion to approve the March 19, 2026, Planning Commission Meeting Minutes was passed by a majority voice vote by all commissioners present.

b) Regular Meeting Minutes of April 2, 2026

CEQA: Not a Project

Recommended Action: Approve

Chair Denison made a motion to approve the April 2, 2026, Meeting Minutes.

Commissioner Brennan seconded the motion.

Ayes: Chair Denison, Vice-Chair Simcock, Commissioner Brennan, and Commissioner Moran

Noes:

Absent:

Abstain: Commissioner Yoo

The motion to approve the April 2, 2026, Planning Commission Meeting Minutes was passed by a majority voice vote by all commissioners present.

8. DISCUSSION ITEMS

a) Annual Review of Conditional Use Permit 21-03 for the Alverno Heights Academy 2021 Master Plan Update

CEQA: Project

Recommended Action: Approve

Assistant Planner Katelyn Huang presented the annual review of Alverno Heights Academy's conditional use permit as required by resolution conditions. The 12-acre institutional campus is located north of Michillinda Avenue between West Grand View Avenue and Highland Avenue.

Huang stated that the city council approved the master plan update in May 2023. The modular classrooms, extended in 2024, were removed by September 2024. At the annual neighborhood meeting on September 16, 2025, attended by city staff, Commissioner Simcock, the police chief, and three neighbors, discussions included pedestrian noise, school traffic, traffic flow changes, and water usage.

The sports courts are completed and have final building permits. From May 2025 to March 2026, there were 13 calls for service, mostly noise complaints, with others about animals, traffic, or disturbances. Staff found no call patterns indicating operational issues outside planned events.

Huang noted no proposed changes or violations to the conditional use permit, master plan findings, or conditions of approval. Calendar events continue to be mailed to neighbors in a timely manner.

Staff recommended the Planning Commission receive and file the annual report, finding Alverno Heights Academy has met the conditions of CUP 21-03.

Commissioners asked clarifying questions about the timeline for future master plan reviews, with staff indicating the full plan spans 10-20 years with periodic reviews.

Community Input

No public comment was received.

Vice-Chair Simcock made a motion to receive and file the Annual Review of Conditional Use Permit 21-03.

Commissioner Yoo seconded the motion.

Ayes: Chair Denison, Vice-Chair Simcock, Commissioner Brennan, Commissioner Moran and Commissioner Yoo

Noes:

Absent:

Abstain:

The motion to receive and file the Annual Review of Conditional Use Permit 21-03 was passed by a majority voice vote by all commissioners present.

9. REPORTS FROM PLANNING COMMISSION

No reports were provided by commissioners.

10. REPORTS FROM CITY STAFF

Planning Director Clare Lin reported that the May 7, 2026, meeting has been advertised for a public hearing on Sierra Madre objective design standards for multifamily zones. The draft standards are being developed through the regional San Gabriel Council of Governments (SGVCOG) with four participating cities. Materials will be provided to commissioners for review in advance of the meeting.

Commissioner Yoo asked about participation levels, with Lin clarifying that four cities are participating in the COG initiative out of a larger regional membership.

11. ADJOURNMENT

The meeting was adjourned at 7:00 pm to the next meeting on May 7, 2026.

Secretary to the Planning Commission
Clare Lin, Director of Planning and Community Preservation